

## 2

---

# Polytopes

Convex polytopes can be equivalently defined as bounded intersections of finitely many halfspaces in some  $\mathbb{R}^d$ , and as convex hulls of finitely many points in  $\mathbb{R}^d$ . A halfspace is defined by a linear inequality, and each nonempty closed convex set in  $\mathbb{R}^d$  is the set of solutions of a system of possibly infinitely many linear inequalities. If we have a finite number of inequalities, then the set is a *polyhedron*. Polyhedra are therefore generalisations of polytopes and polyhedral cones. Many assertions in this chapter, for instance the facial structure of polytopes, are derived from analogous assertions about polyhedra.

In this chapter, we learn how to preprocess objects via projective transformations to simplify problem-solving. We then discuss common examples of polytopes such as pyramids, prisms, simple polytopes, and simplicial polytopes. Section 2.10 considers a construction method for polytopes that inductively adds a vertex at each step. For visualising low-dimensional polytopes, we study Schlegel diagrams, a special type of polytopal complex. We also examine key results in polytope theory such as the Euler–Poincaré–Schläfli equation, the 1971 theorem of Bruggesser and Mani on the existence of shellings (orderings of the facets of a polytope with very useful properties), and the Dehn–Sommerville equations for simplicial polytopes. The chapter ends with Gale transforms, a useful device to study polytopes with a small number of vertices.

### 2.1 Polyhedra

Polyhedra are convex sets that generalise polytopes and polyhedral cones; the latter are defined later in this section. Polyhedra come in two formats: *H*-polyhedra and *V*-polyhedra.

An *H*-polyhedron  $P$  is the set of solutions of a system of finitely many linear inequalities. Notationally,

$$P = \left\{ \begin{pmatrix} x_1 \\ \vdots \\ x_d \end{pmatrix} \in \mathbb{R}^d \mid \begin{array}{l} \alpha_{1,1}x_1 + \cdots + \alpha_{1,d}x_d \leq b_1 \\ \vdots \\ \alpha_{n,1}x_1 + \cdots + \alpha_{n,d}x_d \leq b_n \end{array} \right\}, \text{ or alternatively,}$$

$$P = \left\{ \mathbf{x} \in \mathbb{R}^d \mid M\mathbf{x} \leq \mathbf{b}, \text{ with } M = \begin{pmatrix} \alpha_{1,1} & \cdots & \alpha_{1,d} \\ \vdots & & \vdots \\ \alpha_{n,1} & \cdots & \alpha_{n,d} \end{pmatrix}, \mathbf{b} = \begin{pmatrix} b_1 \\ \vdots \\ b_n \end{pmatrix} \right\}$$

$$=: P(M, \mathbf{b}).$$

We always assume that no two inequalities in the system are the same. For the polyhedron  $P$ , we say that an inequality is *redundant* if its elimination does not alter  $P$ ; otherwise it is *irredundant*. An  $H$ -description of the polyhedron is a definition of it as an  $H$ -polyhedron. When defining  $H$ -descriptions, we favour *irredundant* ones, which include only irredundant inequalities; otherwise the  $H$ -description is *redundant*.

The definition of an  $H$ -polyhedron yields the following at once.

**Proposition 2.1.1** *An  $H$ -polyhedron in  $\mathbb{R}^d$  is a closed convex set.*

*Proof* Each closed halfspace in  $\mathbb{R}^d$  is a closed convex set (see Section 1.6). Besides, the intersection of an arbitrary family of convex sets is a convex set (Theorem 1.6.7), and the intersection of an arbitrary family of closed sets is a closed set. Since an  $H$ -polyhedron is the intersection of closed halfspaces, the result follows. □

We next characterise the nonempty  $H$ -polyhedra that are cones. Let  $\mathbb{R}^{n \times d}$  denote the linear space of  $n \times d$  matrices with entries in  $\mathbb{R}$ .

**Proposition 2.1.2** *Let  $M \in \mathbb{R}^{n \times d}$ . A nonempty  $H$ -polyhedron  $P(M, \mathbf{b})$  in  $\mathbb{R}^d$  is a cone if and only if  $\mathbf{b} = \mathbf{0}_n$ . It is pointed if and only if  $\text{rank } M = d$ .*

*Proof* Suppose  $P := P(M, \mathbf{0}_n)$ ; we show that  $P$  is a cone. Take  $\mathbf{a}_1, \mathbf{a}_2 \in P$  and  $\alpha_1, \alpha_2 \geq 0$ . From  $M\mathbf{a}_1 \leq \mathbf{0}_n$ ,  $M\mathbf{a}_2 \leq \mathbf{0}_n$ , and  $\alpha_1, \alpha_2 \geq 0$ , it follows that

$$M(\alpha_1\mathbf{a}_1 + \alpha_2\mathbf{a}_2) = \alpha_1M\mathbf{a}_1 + \alpha_2M\mathbf{a}_2 \leq \mathbf{0}_n.$$

Hence  $\alpha_1\mathbf{a}_1 + \alpha_2\mathbf{a}_2 \in P$ , implying that  $P$  is a cone.

Suppose that  $P := P(M, \mathbf{b})$  is a cone and  $X := \{\mathbf{x} \in \mathbb{R}^d \mid M\mathbf{x} \leq \mathbf{0}_n\}$ ; we show that  $P = X$ . The point  $\mathbf{0}_d$  is in  $P$ , and so  $\mathbf{b} \geq \mathbf{0}_n$ . It then follows that  $X \subseteq P$ . By way of contradiction, suppose that there exists  $\mathbf{y} \in P \setminus X$ . Then  $\mathbf{r}_i \cdot \mathbf{y} > 0$  for some row vector  $\mathbf{r}_i^t$  of  $M$ . For the corresponding entry  $b_i$  of  $\mathbf{b}$ , we find that  $\mathbf{r}_i \cdot \mathbf{y} \leq b_i$ . Since  $P$  is a cone, we have that  $\alpha\mathbf{y} \in P$  for every

$\alpha \geq 0$ , and consequently that  $r_i \cdot (\alpha y) \leq b_i$  for every  $\alpha \geq 0$ . But the term  $\alpha r_i \cdot y$  cannot be bounded by  $b_i$  for every  $\alpha \geq 0$ . This contradiction shows that such a point  $y$  does not exist, which implies that  $P = X$ .

We now prove the second part of the theorem. Let  $P = P(M, \mathbf{0}_n)$ . Suppose rank  $M < d$ ; we show that  $P$  contains a line. The columns  $c_1, \dots, c_d$  of  $M$  are linearly dependent:

$$a_1 c_1 + \dots + a_d c_d = \mathbf{0}_n \text{ for some } a = (a_1, \dots, a_d)^t \in \mathbb{R}^d \text{ with } a \neq \mathbf{0}_d.$$

Therefore,  $Ma = \mathbf{0}_n$ . This implies that the line  $\{\alpha a \mid \alpha \in \mathbb{R}\}$  is in  $P$ . Now suppose that  $P$  contains the line  $\ell := \{a_1 + \alpha a_2 \mid \alpha \in \mathbb{R}\}$ , for some  $a_1 \in \mathbb{R}^d$  and  $a_2 \neq \mathbf{0}_d$ ; we show that  $Ma_2 = \mathbf{0}_n$ , which would imply that rank  $M < d$ . Suppose that  $Ma_2 \neq \mathbf{0}_n$ . This implies that  $r_i \cdot a_2 \neq 0$  for some row  $r_i^t$  of  $M$ . Then we can find  $\beta \in \mathbb{R}$  for which

$$r_i(a_1 + \beta a_2) = r_i \cdot a_1 + \beta r_i \cdot a_2 > 0.$$

This gives that  $\ell \not\subseteq P$ , a contradiction that settles the part. This completes the proof of the proposition. □

In view of Proposition 2.1.2 we call a set of the form  $P(M, \mathbf{0})$  an *H-cone*.

Orthogonally projecting an *H*-polyhedron onto an affine space produces another *H*-polyhedron; we present a particular instance of this statement, a geometric interpretation of the so-called *Fourier–Motzkin elimination* (Fourier, 1827; Motzkin, 1936).

**Proposition 2.1.3** (Fourier–Motzkin elimination)<sup>1</sup> *Let  $P$  be an  $H$ -polyhedron in  $\mathbb{R}^d$  and let  $\pi$  be the orthogonal projection*

$$(x_1, \dots, x_d)^t \mapsto (x_1, \dots, x_{d-1})^t.$$

*Then  $\pi(P)$  is another  $H$ -polyhedron.*

We now introduce another type of polyhedra. A *V-polyhedron*  $P$  is the sum of a convex hull of finitely many points and a finitely generated cone. Notationally,

$$P = \text{conv } X + \text{cone } Y \text{ for some finite subsets } X, Y \text{ of } \mathbb{R}^d. \tag{2.1.4}$$

This definition implies that *V*-cones are *V*-polyhedra (where  $X = \{\mathbf{0}\}$ ). A convex cone is *polyhedral* if it is a *V*-cone or an *H*-cone.

Definition (2.1.4) also yields that a *V*-polyhedron is a polytope if and only if cone  $Y = \{\mathbf{0}\}$ . We show next that cone  $Y = \{\mathbf{0}\}$  amounts to saying that the *V*-polyhedron is bounded.

<sup>1</sup> A proof is available in Ziegler (1995, sec. 1.2).

**Theorem 2.1.5** *A V-polyhedron is a polytope if and only if it is bounded.*

*Proof* Let  $P := \text{conv } X + \text{cone } Y$  in  $\mathbb{R}^d$  for some finite subsets  $X, Y$  of  $\mathbb{R}^d$ . We show that  $P$  is bounded if and only if  $\text{cone } Y = \{\mathbf{0}\}$ .

Suppose that  $P$  is bounded. Then  $\text{cone } Y = \{\mathbf{0}\}$ : if there were a nonzero point  $z \in \text{cone } Y$ , then  $\alpha z \in \text{cone } Y$  for each  $\alpha \geq 0$ , which would violate the boundedness of  $P$ .

Suppose that  $\text{cone } Y = \{\mathbf{0}\}$ . We show that  $\text{conv } X$  is bounded. Let  $X = \{\mathbf{x}_1, \dots, \mathbf{x}_r\}$  and take  $z \in \text{conv } X$ . Then  $z$  can be written as  $z = \alpha_1 \mathbf{x}_1 + \dots + \alpha_r \mathbf{x}_r$  with  $\alpha_i \geq 0$  and  $\sum_{i=1}^r \alpha_i = 1$ . It follows that

$$\begin{aligned} \|z\| &= \|\alpha_1 \mathbf{x}_1 + \dots + \alpha_r \mathbf{x}_r\| \\ &\leq \|\alpha_1 \mathbf{x}_1\| + \dots + \|\alpha_r \mathbf{x}_r\| \text{ (by the triangle inequality)} \\ &= \alpha_1 \|\mathbf{x}_1\| + \dots + \alpha_r \|\mathbf{x}_r\| \text{ (as } \alpha_i \geq 0 \text{ for each } i \in [1 \dots r])} \\ &\leq \|\mathbf{x}_1\| + \dots + \|\mathbf{x}_r\| \text{ (as } \alpha_i \in [0, 1] \text{ for each } i \in [1 \dots r]).} \end{aligned}$$

Hence  $P$  is bounded. □

**Example 2.1.6** (*d*-cube) We present a *d*-dimensional cube or simply a *d*-cube  $Q(d)$  as an *H*-polyhedron and as a *V*-polyhedron. Figure 2.1.1 shows cubes in  $\mathbb{R}^3$ .

Consider the *standard basis* of  $\mathbb{R}^d$ , namely

$$\mathbf{e}_1 = (1, 0, \dots, 0)^t, \dots, \mathbf{e}_d = (0, \dots, 0, 1)^t.$$

Let  $M$  be the  $2d \times d$  matrix with rows  $\mathbf{e}_1^t, -\mathbf{e}_1^t, \dots, \mathbf{e}_d^t, -\mathbf{e}_d^t$ . Then

$$\begin{aligned} Q(d) &= \left\{ \begin{pmatrix} x_1 \\ \vdots \\ x_d \end{pmatrix} \in \mathbb{R}^d \left| \begin{pmatrix} \mathbf{e}_1^t \\ -\mathbf{e}_1^t \\ \vdots \\ \mathbf{e}_d^t \\ -\mathbf{e}_d^t \end{pmatrix} \begin{pmatrix} x_1 \\ \vdots \\ x_d \end{pmatrix} \leq \begin{pmatrix} 1 \\ \vdots \\ 1 \end{pmatrix} \right\} \\ &= \left\{ \begin{pmatrix} x_1 \\ \vdots \\ x_d \end{pmatrix} \in \mathbb{R}^d \mid |x_1| \leq 1, \dots, |x_d| \leq 1 \right\}. \end{aligned}$$

Let  $X$  be the set of  $2^d$  vectors  $(\pm 1, \dots, \pm 1)^t$  in  $\mathbb{R}^d$ . A *d*-cube can be alternatively defined as the convex hull of  $X$ :

$$Q(d) = \text{conv } X.$$

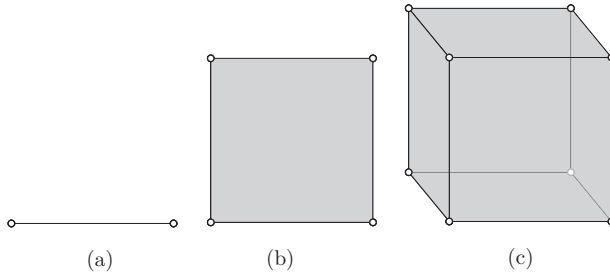

Figure 2.1.1 Cubes in  $\mathbb{R}^3$ . (a) A 1-cube. (b) A 2-cube. (c) A 3-cube.

### Lineality Spaces and Recession Cones

We can readily recover the recession cone, and thus the lineality space, of a polyhedron from its description (see (1.10.5)); these details and the link between the recession cone and the homogenisation cone of a polyhedron ensue.

**Definition 2.1.7** (Homogenisation cone) The *homogenisation cone*  $\hat{P}$  of a polyhedron  $P$  is a cone in  $\mathbb{R}^{d+1}$  whose description is as follows. If  $P = P(M, \mathbf{b}) \subseteq \mathbb{R}^d$  for some  $M \in \mathbb{R}^{n \times d}$  and  $\mathbf{b} \in \mathbb{R}^n$ , then

$$\hat{P} := \left\{ \begin{pmatrix} \mathbf{x} \\ y \end{pmatrix} \in \mathbb{R}^{d+1} \mid \mathbf{x} \in \mathbb{R}^d, y \in \mathbb{R}, \begin{pmatrix} M & -\mathbf{b} \\ \mathbf{0}'_d & -1 \end{pmatrix} \begin{pmatrix} \mathbf{x} \\ y \end{pmatrix} \leq \mathbf{0}_{n+1} \right\}; \quad (2.1.7.1)$$

and if  $P = \text{conv } X + \text{cone } Y \subseteq \mathbb{R}^d$  with  $X := \{\mathbf{a}_1, \dots, \mathbf{a}_r\}$  and  $Y := \{\mathbf{c}_1, \dots, \mathbf{c}_s\}$ , then

$$\hat{P} := \text{cone} \left\{ \begin{pmatrix} \mathbf{a}_1 \\ 1 \end{pmatrix}, \dots, \begin{pmatrix} \mathbf{a}_r \\ 1 \end{pmatrix}, \begin{pmatrix} \mathbf{c}_1 \\ 0 \end{pmatrix}, \dots, \begin{pmatrix} \mathbf{c}_s \\ 0 \end{pmatrix} \right\}. \quad (2.1.7.2)$$

Figure 2.1.2 sketches the homogenisation cone of a polytope. Compare this terminology with the homogenisation of affine spaces presented in Section 1.2.

**Remark 2.1.8** From the definition of a polyhedron  $P \subseteq \mathbb{R}^d$  and its homogenisation cone  $\hat{P} \subseteq \mathbb{R}^{d+1}$ , it follows that

$$\mathbf{x} \in P \text{ if and only if } \begin{pmatrix} \mathbf{x} \\ 1 \end{pmatrix} \in \hat{P}.$$

**Theorem 2.1.9** Let  $P$  be a polyhedron in  $\mathbb{R}^d$ . Then the following hold:

(i) If  $P = P(M, \mathbf{b})$  with  $M \in \mathbb{R}^{n \times d}$  and  $\mathbf{b} \in \mathbb{R}^n$ , then

$$\text{rec } P = \left\{ \mathbf{y} \in \mathbb{R}^d \mid M\mathbf{y} \leq \mathbf{0}_n \right\} \text{ and } \text{lineal } P = \left\{ \mathbf{y} \in \mathbb{R}^d \mid M\mathbf{y} = \mathbf{0}_n \right\}.$$

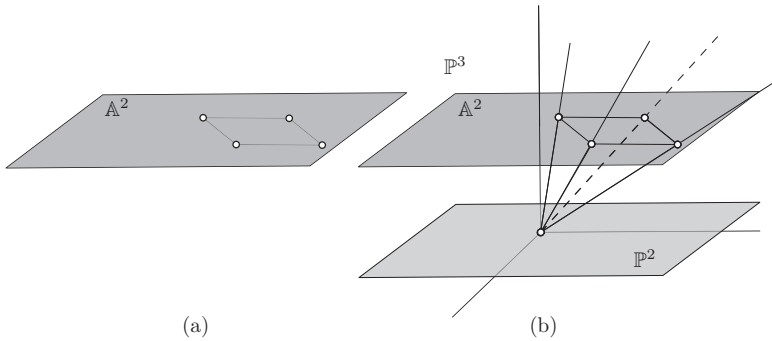

Figure 2.1.2 An affine polytope in  $\mathbb{A}^2$  and its homogenisation cone in  $\mathbb{P}^3$ . (a) A polygon in  $\mathbb{A}^2$ . (b) The homogenisation cone of the polygon in  $\mathbb{P}^3$ .

(ii) If  $P = \text{conv } X + \text{cone } Y$  for some finite subsets  $X, Y$  of  $\mathbb{R}^d$ , then  $\text{rec } P = \text{cone } Y$ .

(iii) 
$$\hat{P} = \left\{ \alpha \begin{pmatrix} \mathbf{x} \\ 1 \end{pmatrix} \mid \mathbf{x} \in P, \alpha > 0 \right\} + \left\{ \begin{pmatrix} \mathbf{y} \\ 0 \end{pmatrix} \mid \mathbf{y} \in \text{rec } P \right\}$$

*Proof* (i) We prove the equality related to  $\text{rec } P$ ; the one related to  $\text{lineal } P$  would then follow from (1.10.5).

Suppose that  $\mathbf{y} \in \text{rec } P$ . Then  $\mathbf{x} + \alpha \mathbf{y} \in P$  for each  $\mathbf{x} \in P$  and each  $\alpha \geq 0$ . In particular, for a fixed  $\mathbf{x}' \in P$  and every  $\alpha \geq 0$ , we have that  $M(\mathbf{x}' + \alpha \mathbf{y}) \leq \mathbf{b}$  or, equivalently, that

$$\alpha M\mathbf{y} \leq \mathbf{b} - M\mathbf{x}'. \tag{2.1.9.1}$$

Since the right hand side of (2.1.9.1) is a fixed vector, the inequality wouldn't hold for every  $\alpha \geq 0$  in case that  $M\mathbf{y} > \mathbf{0}$ . As a consequence,  $M\mathbf{y} \leq \mathbf{0}$ , and  $\text{rec } P \subseteq \{\mathbf{y} \in \mathbb{R}^d \mid M\mathbf{y} \leq \mathbf{0}\}$ .

Suppose that  $\mathbf{y} \in \mathbb{R}^d$  satisfies  $M\mathbf{y} \leq \mathbf{0}$ . Then  $\alpha M\mathbf{y} \leq \mathbf{0}$  for each  $\alpha \geq 0$ . It follows, for every  $\mathbf{x} \in P$ , that  $M(\mathbf{x} + \alpha \mathbf{y}) \leq \mathbf{b}$ ; that is,  $\mathbf{x} + \alpha \mathbf{y} \in P$  and  $\{\mathbf{y} \in \mathbb{R}^d \mid M\mathbf{y} \leq \mathbf{0}\} \subseteq \text{rec } P$ . This proves (i).

(ii) Suppose that  $\mathbf{y} \in \text{rec } P$ . Then, for a fixed  $\mathbf{x}' \in \text{conv } X$  and each  $\alpha \geq 0$ , we have that  $\mathbf{x}' + \alpha \mathbf{y} \in \text{conv } X + \text{cone } Y$ . The set  $\text{conv } X$  is bounded, and so  $\mathbf{y} \in \text{cone } Y$ . Hence  $\text{rec } P \subseteq \text{cone } Y$ .

Suppose that  $\mathbf{y} \in \text{cone } Y$ . Then, for each  $\alpha \geq 0$ , we have that  $\alpha \mathbf{y} \in \text{cone } Y$ . It follows that  $\mathbf{x} + \alpha \mathbf{y} \in \text{conv } X + \text{cone } Y$ , for each  $\alpha \geq 0$  and each  $\mathbf{x} \in P$ . Hence  $\text{cone } Y \subseteq \text{rec } P$ .

(iii) This follows easily from the definitions of a recession cone, given in (1.10.4) and a homogenisation cone (Definition 2.1.7). □

Combining Theorem 2.1.5 and Theorem 2.1.9 gives another characterisation of polytopes.

**Theorem 2.1.10** *A polyhedron  $P$  in  $\mathbb{R}^d$  is a polytope if and only if  $\text{rec } P = \{\mathbf{0}\}$ .*

## 2.2 Representation Theorems

Example 2.1.6 describes a  $d$ -cube as an  $H$ -polyhedron and as a  $V$ -polyhedron. This is not a coincidence;  $H$ -polyhedra and  $V$ -polyhedra are two independent mathematical representations of the same objects.

It has become standard practice to resort to the representation theorem for cones (2.2.1) to prove the representation theorem for polyhedra (2.2.2) and then obtain the representation theorem for polytopes (2.2.4) as a particular case of the one for polyhedra. We follow this approach as well.

**Theorem 2.2.1** (Representation theorem for cones)<sup>2</sup> *A subset of  $\mathbb{R}^d$  is a  $V$ -cone if and only if it is an  $H$ -cone.*

**Theorem 2.2.2** (Representation theorem for polyhedra) *A subset of  $\mathbb{R}^d$  is a  $V$ -polyhedron if and only if it is an  $H$ -polyhedron.*

*Proof* In both directions of the proof, given a polyhedron  $P$  in  $\mathbb{R}^d$ , we construct its homogenisation cone  $\hat{P}$  in  $\mathbb{R}^{d+1}$  (Definition 2.1.7), which has the property that

$$\mathbf{x} \in P \text{ if and only if } \begin{pmatrix} \mathbf{x} \\ 1 \end{pmatrix} \in \hat{P} \tag{2.2.2.1}$$

(see Remark 2.1.8) and then resort to the representation theorem for cones (2.2.1).

Suppose  $P = P(M, \mathbf{b})$  is an  $H$ -polyhedron in  $\mathbb{R}^d$  for some  $n \times d$  matrix  $M$  and some vector  $\mathbf{b} \in \mathbb{R}^n$ ; we represent  $P$  as a  $V$ -polyhedron. The homogenisation cone  $\hat{P}$  has the form

$$\begin{aligned} \hat{P} &= \left\{ \begin{pmatrix} \mathbf{x} \\ y \end{pmatrix} \in \mathbb{R}^{d+1} \mid \mathbf{x} \in \mathbb{R}^d, y \in \mathbb{R}, y \geq 0, M\mathbf{x} \leq y\mathbf{b} \right\} \\ &= \left\{ \begin{pmatrix} \mathbf{x} \\ y \end{pmatrix} \in \mathbb{R}^{d+1} \mid \mathbf{x} \in \mathbb{R}^d, y \in \mathbb{R}, \begin{pmatrix} M & -\mathbf{b} \\ \mathbf{0}_d^t & -1 \end{pmatrix} \begin{pmatrix} \mathbf{x} \\ y \end{pmatrix} \leq \mathbf{0}_{n+1} \right\}. \end{aligned}$$

<sup>2</sup> A proof is available in Ziegler (1995, sec. 1.3).

The representation theorem for cones (2.2.1) ensures that  $\hat{P}$  can be represented as a  $V$ -cone in  $\mathbb{R}^{d+1}$ , say

$$\hat{P} = \text{cone} \left\{ \begin{pmatrix} \mathbf{a}_1 \\ \alpha_1 \end{pmatrix}, \dots, \begin{pmatrix} \mathbf{a}_m \\ \alpha_m \end{pmatrix} \right\}. \tag{2.2.2.2}$$

Since  $y \geq 0$  and the elements of  $\hat{P}$  are positive combinations of the generators of  $\hat{P}$ , we may assume that  $\alpha_i = 0$  or  $1$  for each  $i \in [1 \dots m]$ . Without loss of generality, we further assume that  $\alpha_i = 1$  for  $i \in [1 \dots r]$  and  $\alpha_j = 0$  for  $j \in [r + 1 \dots m]$ . We then partition the set  $\{\mathbf{a}_1, \dots, \mathbf{a}_r, \mathbf{a}_{r+1}, \dots, \mathbf{a}_m\}$  into subsets  $X$  and  $Y$  according to the sign of  $\alpha_i$ :

$$X = \{\mathbf{a}_1, \dots, \mathbf{a}_r\} \text{ and } Y = \{\mathbf{a}_{r+1}, \dots, \mathbf{a}_m\}.$$

By (2.2.2.1) and (2.2.2.2),  $P$  can be expressed as

$$P = \text{conv } X + \text{cone } Y,$$

which is a representation of it as a  $V$ -polyhedron.

Now suppose that  $P = \text{conv } X + \text{cone } Y$  is a  $V$ -polyhedron in  $\mathbb{R}^d$  where  $X := \{\mathbf{a}_1, \dots, \mathbf{a}_r\}$  and  $Y := \{\mathbf{c}_1, \dots, \mathbf{c}_s\}$ . The homogenisation cone of  $P$  has the form

$$\hat{P} = \text{cone} \left\{ \begin{pmatrix} \mathbf{a}_1 \\ 1 \end{pmatrix}, \dots, \begin{pmatrix} \mathbf{a}_r \\ 1 \end{pmatrix}, \begin{pmatrix} \mathbf{c}_1 \\ 0 \end{pmatrix}, \dots, \begin{pmatrix} \mathbf{c}_s \\ 0 \end{pmatrix} \right\}.$$

By the representation theorem for cones,  $\hat{P}$  can be written as an  $H$ -cone  $P(N, \mathbf{0}_n)$  for some  $n \times (d + 1)$  matrix  $N$ . Let  $M$  be the  $n \times d$  matrix formed by the first  $d$  columns of  $N$  and let  $-\mathbf{b}$  be the last column of  $N$ . It follows that

$$\begin{aligned} \hat{P} &= \left\{ \begin{pmatrix} \mathbf{x} \\ y \end{pmatrix} \in \mathbb{R}^{d+1} \mid \mathbf{x} \in \mathbb{R}^d, y \in \mathbb{R}, N \begin{pmatrix} \mathbf{x} \\ y \end{pmatrix} \leq \mathbf{0}_n \right\} \\ &= \left\{ \begin{pmatrix} \mathbf{x} \\ y \end{pmatrix} \in \mathbb{R}^{d+1} \mid \mathbf{x} \in \mathbb{R}^d, y \in \mathbb{R}, M\mathbf{x} \leq y\mathbf{b} \right\}. \end{aligned}$$

From (2.2.2.1) we now find that

$$P = \left\{ \mathbf{x} \in \mathbb{R}^d \mid M\mathbf{x} \leq \mathbf{b} \right\},$$

which is a representation of  $P$  as an  $H$ -polyhedron. This completes the proof of the theorem. □

By the representation theorem for polyhedra (2.2.2), a set is a bounded  $V$ -polyhedron if and only if it is a bounded  $H$ -polyhedron. Combining this with Theorem 2.1.5, we get at once a characterisation of polytopes.



**Theorem 2.2.3** (Polytopes as bounded polyhedra) *A subset of  $\mathbb{R}^d$  is a polytope if and only if it is a bounded polyhedron.*

Thanks to Theorem 2.2.3, we now have two alternative ways of describing polytopes. An *H-polytope* is a bounded *H-polyhedron* and a *V-polytope* is a bounded *V-polyhedron*. Moreover, since polytopes are bounded polyhedra, the representation theorem for polyhedra yields that *H-polytopes* and *V-polytopes* are equivalent from a mathematical point of view.

**Theorem 2.2.4** (Representation theorem for polytopes) *A subset of  $\mathbb{R}^d$  is a V-polytope if and only if it is an H-polytope.*

From a computational point of view, a *V-polytope* is, however, different from an *H-polytope*. It is trivial to decide whether a given point is in an *H-polytope*: saying yes if the point satisfies each inequality and no otherwise. It is also trivial to compute the maximum of a linear functional over a *V-polytope*: evaluate the function at each point in *V* and return a maximum value. But the standard method to decide whether a point is in a *V-polytope* is polynomially equivalent to the *basic problem from linear programming* (Fukuda, 2022), the problem of maximising a linear objective function subject to a finite set of linear inequalities. And maximising a linear functional over an *H-polytope* is essentially the basic problem of linear programming when the intersection of the inequalities is bounded. While linear programming problems, also called *linear programs*, can be solved in polynomial time (Khachiyan, 1979), solving them is certainly not trivial.

## 2.3 Faces

Convex sets are structured around their faces and these faces can be very heterogeneous: there are convex sets with both exposed and unexposed faces, convex sets with bounded and unbounded faces, and convex sets with a finite number of faces of some dimension and an infinite number of faces of another dimension (Section 1.9). In contrast, the facial structure of polyhedra possesses many attractive properties that are not shared by general convex sets (Theorem 2.3.1). In this section, our focus narrows to explore the faces of polyhedra.

Every proper face of a polyhedron is exposed and is contained in a *facet* of the polyhedron, a face whose dimension is one less than that of the polyhedron. It is also the case that every face of the polyhedron is another polyhedron. We offer the facial structure of polyhedra thereafter.

For a polyhedron  $P := \{\mathbf{x} \in \mathbb{R}^d \mid M\mathbf{x} \leq \mathbf{1}\}$ , we say that an inequality is *active* at a subset  $Y$  of  $P$  if the inequality is satisfied with equality for all points of  $Y$ .

**Theorem 2.3.1** (Facial structure of polyhedra) *Let  $\mathbf{r}_1, \dots, \mathbf{r}_n$  be nonzero vectors in  $\mathbb{R}^d$ , and let  $P$  be a  $d$ -dimensional polyhedron in  $\mathbb{R}^d$  with the  $H$ -description*

$$P = \bigcap_{i=1}^n \{\mathbf{x} \in \mathbb{R}^d \mid \mathbf{r}_i \cdot \mathbf{x} \leq 1\} = \{\mathbf{x} \in \mathbb{R}^d \mid M\mathbf{x} \leq \mathbf{1}_n\},$$

where  $M$  is the matrix with the rows  $\mathbf{r}_1^t, \dots, \mathbf{r}_n^t$ . Then the following hold:

(i) *The interior and boundary of  $P$  can be expressed as follows:*

$$\begin{aligned} \text{int } P &= \{\mathbf{x} \in \mathbb{R}^d \mid M\mathbf{x} < \mathbf{1}_n\}, \\ \text{bd } P &= \bigcup_{i=1}^n \left( P \cap \{\mathbf{x} \in \mathbb{R}^d \mid \mathbf{r}_i \cdot \mathbf{x} = 1\} \right). \end{aligned}$$

- (ii) *Every facet of  $P$  is exposed, and of the form  $P \cap \{\mathbf{x} \in \mathbb{R}^d \mid \mathbf{r}_j \cdot \mathbf{x} = 1\}$  for some  $j \in [1 \dots n]$ .*
- (iii) *Every set  $P \cap \{\mathbf{x} \in \mathbb{R}^d \mid \mathbf{r}_j \cdot \mathbf{x} = 1\}$  is a facet of  $P$  if and only if the  $H$ -description of  $P$  is irredundant.*
- (iv) *Every proper face  $F$  of  $P$  is the intersection of the facets of  $P$  that contain it. Thus, if there are  $t$  facets containing  $F$  and we let  $M'\mathbf{x} \leq \mathbf{1}_t$  be the subsystem of  $M\mathbf{x} \leq \mathbf{1}_n$  formed by the  $t$  inequalities of  $M\mathbf{x} \leq \mathbf{1}_n$  active at  $F$ , then  $F$  has the form  $\{\mathbf{x} \in P \mid M'\mathbf{x} = \mathbf{1}_t\}$ .*
- (v) *Every proper face of  $P$  is exposed and polyhedral.*
- (vi) *The number of faces of  $P$  is finite.*
- (vii) *The faces of a face  $F$  of  $P$  are precisely the faces of  $P$  that are contained in  $F$ .*
- (viii) *For any two proper faces  $F, K$  of  $P$ , with  $K$  not contained in  $F$ , there is a facet containing  $K$  but not  $F$ , and vice versa. In particular, for any two distinct vertices, there is a facet containing one but not the other.*
- (ix) *For every proper face  $F$  of  $P$ , it holds that  $\text{lineal } F = \text{lineal } P$ .*

*Proof* Let  $H_i := \{\mathbf{x} \in \mathbb{R}^d \mid \mathbf{r}_i \cdot \mathbf{x} = 1\}$  and  $H_i^- := \{\mathbf{x} \in \mathbb{R}^d \mid \mathbf{r}_i \cdot \mathbf{x} \leq 1\}$ , for each  $i \in [1 \dots n]$ .

(i) The proof of (i) is simple. The interior of  $P$  is the intersection of the interiors of the supporting halfspaces of  $P$  (Theorem 1.8.3), which can be found among the halfspaces  $H_1^-, \dots, H_n^-$ . Furthermore, the interior of  $H_i^-$  is  $H_i^- \setminus H_i$ . Thus, it follows that

$$\text{int } P = \bigcap_{i=1}^n H_i^- \setminus H_i = \left\{ \mathbf{x} \in \mathbb{R}^d \mid M\mathbf{x} < \mathbf{1}_n \right\}. \tag{2.3.1.1}$$

Since  $P$  is a closed set, the other part follows from (2.3.1.1) and the assertion that  $\text{bd } P = P \setminus \text{int } P$  (Proposition 1.7.8).

(ii) Let  $F$  be a facet of  $P$ . Take  $\mathbf{z} \in \text{rint } F$ . Since  $F \subseteq \text{bd } P$  (Theorem 1.9.9), Part (i) gives that  $\mathbf{z} \in (P \cap H_j)$  for some  $j \in [1 \dots n]$ . Furthermore, Theorem 1.9.6(iii) yields that  $P \cap H_j$  is a proper face of  $P$ . According to Theorem 1.9.10,  $F$  is the smallest face of  $P$  containing  $\mathbf{z}$  and so  $F \subseteq P \cap H_j$ . This implies that  $F = P \cap H_j$  as  $d - 1 = \dim F \leq \dim(P \cap H_j) \leq d - 1$ . Hence  $F$  is exposed.

(iii) If the  $H$ -description of  $P$  is redundant, then there is an index  $j \in [1 \dots n]$  such that

$$P = \bigcap_{\substack{i=1 \\ i \neq j}}^n H_i^-. \tag{2.3.1.2}$$

We show that  $P \cap H_j$  is not a facet of  $P$ . Suppose otherwise. Let  $\mathbf{z} \in \text{rint}(P \cap H_j)$ . From (i) and (2.3.1.2) follows the existence of an index  $\ell \in [1 \dots n]$  with  $\ell \neq j$  such that  $\mathbf{z} \in (P \cap H_\ell)$ . Since  $P \cap H_\ell$  is a face of  $P$  and since  $P \cap H_j$  is a facet and is the smallest face of  $P$  containing  $\mathbf{z}$  (Theorem 1.9.10), we get that  $P \cap H_j = P \cap H_\ell$ . This implies that  $H_j^- = H_\ell^-$ , contradicting our running assumption that no two closed halfspaces in the description of a polyhedron are identical. This shows that  $P \cap H_j$  is not a facet.

Suppose that the  $H$ -description of  $P$  is irredundant. Then, for each  $i \in [1 \dots n]$ , every hyperplane  $H_i$  supports  $P$ , and so every set  $F_i := P \cap H_i$  is a proper face of  $P$  by Theorem 1.9.6(iii). Pick  $j \in [1 \dots n]$ ; we show that  $F_j$  is a facet of  $P$ .

Because the  $H$ -description of  $P$  is irredundant, there is a point  $\mathbf{y}_j \in \mathbb{R}^d$  such that

$$\mathbf{r}_j \cdot \mathbf{y}_j > 1 \text{ and } \mathbf{r}_i \cdot \mathbf{y}_j \leq 1 \text{ for each } i \in [1 \dots n] \text{ with } i \neq j. \tag{2.3.1.3}$$

Now choose a point  $\mathbf{z} \in \text{int } P$  (which exists by Theorem 1.7.3). Then

$$\mathbf{r}_i \cdot \mathbf{z} < 1 \text{ for each } i \in [1 \dots n]. \tag{2.3.1.4}$$

Because of (2.3.1.3) and (2.3.1.4), we can find a number  $\alpha_j \in (0, 1)$  such that the point  $\mathbf{u}_j := \alpha_j \mathbf{y}_j + (1 - \alpha_j)\mathbf{z}$  of the segment  $[\mathbf{y}_j, \mathbf{z}]$  satisfies

$$\mathbf{r}_j \cdot \mathbf{u}_j = 1 \text{ and } \mathbf{r}_i \cdot \mathbf{u}_j < 1 \text{ for each } i \in [1 \dots n] \text{ with } i \neq j, \tag{2.3.1.5}$$

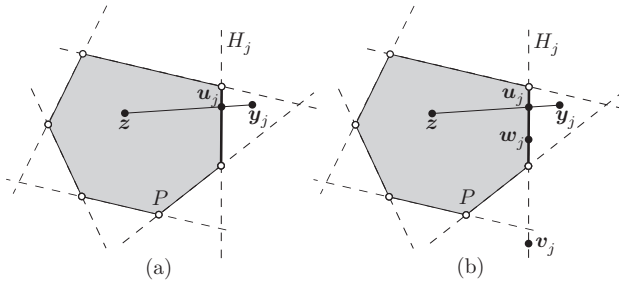

Figure 2.3.1 Auxiliary figure for Theorem 2.3.1. Depicted is a polyhedron  $P$ , a hyperplane  $H_j$  supporting  $P$ , a point  $z_j$  in the interior of  $P$ , and a point  $y_j$  outside  $P$ . (a) A point  $u_j$  in the segment  $[y_j, z]$  satisfying (2.3.1.5). (b) A point  $v_j$  lying in a line between the points  $u_j$  and  $w_j$  of  $F_j$ .

namely  $\alpha_j = (1 - r_j \cdot z) / (r_j \cdot y_j - r_j \cdot z)$ ; see Fig. 2.3.1(a). From Condition (2.3.1.5) it follows that  $u_j$  is in  $F_j$ . We show that

$$\text{aff } F_j = H_j. \tag{2.3.1.6}$$

Because  $F_j = P \cap H_j$ , it is clear that  $\text{aff } F_j \subseteq H_j$ ; we prove the other direction. Let  $v_j \in H_j$ . Choose  $\beta_j > 0$  so that

$$\beta_j(r_i \cdot v_j - r_i \cdot u_j) \leq 1 - r_i \cdot u_j \text{ for each } i \in [1 \dots n] \text{ with } i \neq j,$$

which is possible because of Condition (2.3.1.5). The choice of  $\beta_j$  ensures that the point  $w_j := \beta_j v_j + (1 - \beta_j)u_j$  satisfies the conditions  $r_j \cdot w_j = 1$  and  $r_i \cdot w_j \leq 1$  for each  $i \neq j$ :

$$\begin{aligned} r_j \cdot w_j &= r_j \cdot (\beta_j v_j + (1 - \beta_j)u_j) = \beta_j r_j \cdot v_j + (1 - \beta_j)r_j \cdot u_j \\ &= \beta_j + (1 - \beta_j) = 1, \text{ (since } v_j, u_j \in H_j) \\ r_i \cdot w_j &= r_i \cdot (\beta_j v_j + (1 - \beta_j)u_j) = \beta_j r_i \cdot v_j + (1 - \beta_j)r_i \cdot u_j \\ &= \beta_j(r_i \cdot v_j - r_i \cdot u_j) + r_i \cdot u_j \leq 1. \end{aligned}$$

As a consequence, we have that  $w_j \in F_j$  and

$$v_j = \frac{1}{\beta_j} w_j + \left(1 - \frac{1}{\beta_j}\right) u_j,$$

and so  $v_j$  is in the line between  $w_j$  and  $u_j$ , two points of  $F_j$ ; see Fig. 2.3.1(b). Hence  $v_j \in \text{aff } F_j$ . This proves (2.3.1.6) and, with it, that  $F_j$  is a facet of  $P$ .

(iv) Without loss of generality, we assume that the  $H$ -description of  $P$  is irredundant. Let  $F$  be a proper face of  $P$  and let  $z \in \text{rint } F$ . Since  $F \subseteq \text{rbd } P$  (Theorem 1.9.9), part (i) yields that  $F \subseteq P \cap H_\ell$  for some  $\ell \in [1 \dots n]$ , and

so  $\mathbf{z} \in P \cap H_\ell$ . Let  $F_r := P \cap H_r$  for each  $r \in [1 \dots n]$ . Then  $F_r$  is a facet for each  $r \in [1 \dots n]$ , by (iii).

Partition the set  $[1 \dots n]$  into the subindices  $I$  of the facets  $F_i$  of  $P$  that contain  $\mathbf{z}$ , namely those satisfying  $\mathbf{r}_i \cdot \mathbf{z} = 1$  and the subindices  $J$  of the facets  $F_j$  of  $P$  that do not contain  $\mathbf{z}$ , namely those satisfying  $\mathbf{r}_j \cdot \mathbf{z} < 1$ . Let

$$K := \bigcap_{i \in I} F_i.$$

The face  $F$  is the smallest face containing  $\mathbf{z}$ , which gives that  $F \subseteq F_i$  for each  $i \in I$  and therefore that  $F \subseteq K$ . Thus  $K$  is a face of  $P$  that contains  $F$ . We show that  $\mathbf{z} \in \text{rint } K$ , which gives us  $F = K$ .

Because  $\mathbf{r}_j \cdot \mathbf{z} < 1$  for each  $j \in J$ , we can choose a radius  $r > 0$  small enough that the open ball  $B(\mathbf{z}, r)$  satisfies

$$B(\mathbf{z}, r) \subseteq \bigcap_{j \in J} \left\{ \mathbf{x} \in \mathbb{R}^d \mid \mathbf{r}_j \cdot \mathbf{x} < 1 \right\}. \tag{2.3.1.7}$$

The definition of  $K$  ensures that

$$\text{aff } K \subseteq \bigcap_{i \in I} \left\{ \mathbf{x} \in \mathbb{R}^d \mid \mathbf{r}_i \cdot \mathbf{x} = 1 \right\}. \tag{2.3.1.8}$$

By combining (2.3.1.7) and (2.3.1.8) we finally get that

$$B(\mathbf{z}, r) \cap \text{aff } K \subseteq K,$$

and therefore we conclude that  $\mathbf{z} \in \text{rint } K$  (see (1.7.2)). Hence  $F = K$  and  $F$  is the intersection of the facets that contain it. From (iii), it follows that if  $t := |I|$ , then

$$F = \{ \mathbf{x} \in P \mid M' \mathbf{x} = \mathbf{1}_t \}$$

for the subsystem  $M' \mathbf{x} \leq \mathbf{1}_t$  of  $M \mathbf{x} \leq \mathbf{1}_n$  formed by the  $t$  inequalities of  $M \mathbf{x} \leq \mathbf{1}_n$  active at  $F$ .

(v) From (ii) we get that every facet of  $P$  is exposed, and from (iv) that every proper face  $F$  of  $P$  is the intersection of the facets that contain it. That  $F$  is exposed now follows from Proposition 1.9.8, which states that the intersection of exposed faces is also exposed.

The assertion of  $F$  being polyhedral is an immediate consequence of (iv) as

$$F = \{ \mathbf{x} \in P \mid M' \mathbf{x} = \mathbf{1}' \}$$

for the subsystem  $M' \mathbf{x} \leq \mathbf{1}'$  of  $M \mathbf{x} \leq \mathbf{1}_n$  formed by the  $t$  inequalities of  $M \mathbf{x} \leq \mathbf{1}_n$  active at  $F$ .

(vi) This is an easy consequence of (iv). There is a finite number of facets in  $P$  and every face of  $P$  is the intersection of the facets that contain it.

(vii) Let  $K \subseteq F$ . If  $K$  is a face of  $P$ , then the definition of a face (see (1.9.1)) yields that  $K$  is a face of the face  $F$ . Moreover, since  $F$  is a face of  $P$ , the transitivity of the relation ‘is a face of’ on the faces of  $P$  (Proposition 1.9.3) ensures that  $K$  is a face of  $P$ .

(viii) This is a direct consequence of (iv).

(ix) Suppose that  $\{x \in \mathbb{R}^d \mid Mx \leq \mathbf{1}\}$  is an irredundant description of  $P$ .  
Let

$$\{x \in \mathbb{R}^d \mid M'x \leq \mathbf{1}'\}$$

be the subsystem of  $Mx \leq \mathbf{1}$  comprising all the inequalities of  $P$  active at the face  $F$  and let

$$\{x \in \mathbb{R}^d \mid M''x \leq \mathbf{1}''\}$$

be the remaining inequalities of  $Mx \leq \mathbf{1}$ . Then according to (iv),

$$F = \{x \in \mathbb{R}^d \mid M'x = \mathbf{1}' \text{ and } M''x \leq \mathbf{1}''\}. \tag{2.3.1.9}$$

It is now clear from (2.3.1.9) and Theorem 2.1.9 that

$$\begin{aligned} \text{lineal } F &= \{x \in \mathbb{R}^d \mid M'x = \mathbf{0}' \text{ and } M''x = \mathbf{0}''\} = \{x \in \mathbb{R}^d \mid Mx = \mathbf{0}\} \\ &= \text{lineal } P. \end{aligned}$$

This settles the part and, with it, the theorem. □

One of the consequences of Theorem 2.3.1 is that a face  $F$  of an  $H$ -polyhedron  $P$  is the intersection of  $P$  with the solution of a system of linear equations. This gives rise to an expression for the dimension of  $F$  thanks to Proposition 1.1.8.

**Proposition 2.3.2** *Let  $M \in \mathbb{R}^{n \times d}$  and let  $P := P(M, \mathbf{1}_n)$  be an irredundant  $H$ -description of a nonempty  $d$ -dimensional polyhedron in  $\mathbb{R}^d$ . Suppose that a proper face  $F$  of  $P$  is the solution of the subsystem  $M'x \leq \mathbf{1}'$  of  $Mx \leq \mathbf{1}_n$  formed by the inequalities of  $Mx \leq \mathbf{1}_n$  active at  $F$ :*

$$F = \{x \in P \mid M'x = \mathbf{1}'\}.$$

Then

$$\begin{aligned} \text{aff } F &= \{x \in \mathbb{R}^d \mid M'x = \mathbf{1}'\}, \\ \dim F &= d - \text{rank } M'. \end{aligned}$$

*Proof* It suffices to prove the expression for  $\text{aff } F$ ; once this is given, the expression for  $\dim F$  follows at once from Proposition 1.1.8.

Let  $A := \{\mathbf{x} \in \mathbb{R}^d \mid M'\mathbf{x} = \mathbf{1}'\}$ , let  $\vec{A} := \{\mathbf{x} \in \mathbb{R}^d \mid M'\mathbf{x} = \mathbf{0}'\}$  be the direction of  $A$ , and let  $\{\mathbf{x} \in \mathbb{R}^d \mid M''\mathbf{x} \leq \mathbf{1}''\}$  be the subsystem of  $M\mathbf{x} \leq \mathbf{1}_n$  comprising all the inequalities of  $P$  not active at  $F$ . From the definition of  $F$ , we have that  $F \subseteq A$  and

$$F = \left\{ \mathbf{x} \in \mathbb{R}^d \mid M'\mathbf{x} = \mathbf{1}' \text{ and } M''\mathbf{x} \leq \mathbf{1}'' \right\}. \tag{2.3.2.1}$$

Let  $r := d - \text{rank } M'$ . Then, according to Proposition 1.1.8,  $\dim A = \dim \vec{A} = r$ . We find  $r + 1$  affinely independent points in  $F$ , which will show that  $\text{aff } F = A$ .

We first choose a basis  $\mathbf{l}_1, \dots, \mathbf{l}_r$  of  $\vec{A}$ . Then  $M'\mathbf{l}_i = \mathbf{0}'$  for each  $i \in [1 \dots r]$ . Let  $\mathbf{z} \in \text{rint } F$ . Then  $F$  is the smallest face containing  $\mathbf{z}$  (Theorem 1.9.10), which implies that  $M''\mathbf{z} < \mathbf{1}''$  and  $\mathbf{z} \notin \vec{A}$ . Then for a sufficiently small  $\varepsilon > 0$ , the points  $\mathbf{z}, \mathbf{z} + \varepsilon\mathbf{l}_1, \dots, \mathbf{z} + \varepsilon\mathbf{l}_r$  are affinely independent. Additionally, by choosing  $\varepsilon$  appropriately, we can ensure that all these points are contained within  $F$ , with each satisfying (2.3.2.1):

$$\begin{aligned} M'(\mathbf{z} + \varepsilon\mathbf{l}_i) &= M'\mathbf{z} + \varepsilon M'\mathbf{l}_i = \mathbf{1}', \\ M''(\mathbf{z} + \varepsilon\mathbf{l}_i) &= M''\mathbf{z} + \varepsilon M''\mathbf{l}_i \\ &\leq \mathbf{1}'' + \varepsilon M''\mathbf{l}_i \leq \mathbf{1}''. \end{aligned}$$

Thus  $\dim F = r$ , concluding that  $\text{aff } F = A$ . □

In the realm of polyhedra, it is customary to call extreme points *vertices* and 1-faces *edges*. We follow the same convention from now on, and for a polyhedron  $P$  we denote by  $\mathcal{V}(P)$  the set of its vertices and by  $v(P)$  the number of elements in  $\mathcal{V}(P)$ . We also denote by  $\mathcal{E}(P)$  the set of edges of  $P$  and by  $e(P)$  the number of elements in  $\mathcal{E}(P)$ . The undirected graph formed by the vertices and edges of  $P$ , denoted by  $G(P)$ , is the *graph* of the polyhedron  $P$ .

A polyhedron  $P(M, \mathbf{1})$  in  $\mathbb{R}^d$  is pointed if and only if  $\text{rank } M = d$  (Proposition 2.1.2). An alternative characterisation involves the existence of minimal faces. A *minimal face* of a polyhedron  $P$  is a proper face that contains no other face of  $P$ .

**Theorem 2.3.3** (Hoffman and Kruskal 1956)<sup>3</sup> *Let  $P$  be a  $d$ -dimensional polyhedron in  $\mathbb{R}^d$  with the irredundant  $H$ -description*

$$P = \left\{ \mathbf{x} \in \mathbb{R}^d \mid M\mathbf{x} \leq \mathbf{1} \right\} \text{ for some } M \in \mathbb{R}^{n \times d}.$$

<sup>3</sup> A proof is available in Conforti et al. (2014, Thm. 3.3).

Then the following hold:

(i) A proper face  $F$  of  $P$  is minimal if and only if

$$F = \left\{ \mathbf{x} \in \mathbb{R}^d \mid M'\mathbf{x} = \mathbf{1}' \right\} \text{ for some subsystem } M'\mathbf{x} \leq \mathbf{1}' \text{ of } M\mathbf{x} \leq \mathbf{1}.$$

That is,  $M'\mathbf{x} \leq \mathbf{1}'$  is formed by the inequalities of  $M\mathbf{x} \leq \mathbf{1}_n$  active at  $F$ .

(ii)  $\text{rank } M' = \text{rank } M$ .

(iii) A minimal face of  $P$  is a translate of the lineality space of  $P$ .

A consequence of Theorem 2.3.3 is that a nonempty polyhedron is pointed if and only if its minimal faces are vertices; this is the origin of the term “pointed”: the minimal faces are points. And if the polyhedron has a vertex, then its lineality space must be  $\{\mathbf{0}\}$ .

**Corollary 2.3.4** A nonempty polyhedron is pointed if and only if it has a vertex.

A polytope of dimension  $d$  is referred to as a  $d$ -polytope. A flag of a  $d$ -polytope is a sequence of faces such that each face is a proper face of the next face in the sequence: a sequence

$$F_1 \subset \dots \subset F_\ell$$

of faces such that  $-1 \leq \dim F_1 < \dots < \dim F_\ell \leq d$ . A flag is complete if it includes faces of every dimension from  $-1$  to  $d$ .

**Theorem 2.3.5** Let  $P$  be a  $d$ -polytope in  $\mathbb{R}^d$ . For every  $i$ -face  $F_i$  and every  $j$ -face  $F_j$  of  $P$  such that  $-1 \leq i < j - 1$  and  $F_i \subset F_j$ , there is a flag in  $P$  such that

$$F_i \subset F_{i+1} \subset \dots \subset F_{j-1} \subset F_j,$$

and  $F_\ell$  is a facet of  $F_{\ell+1}$  for each  $\ell \in [i \dots j - 1]$ .

*Proof* First suppose that  $-1 < i$ , so that  $F_i \neq \emptyset$ . Then the face  $F_i$  is a proper face of  $F_j$  by Theorem 2.3.1(v). Since  $F_j$  is a polytope there exists a facet  $F_{j-1}$  of  $F_j$  containing  $F_i$  (Theorem 2.3.1). In the case  $i = j - 2$  we are done. Otherwise, we argue as before, replacing  $F_j$  by  $F_{j-1}$ , and this argument is repeated  $j - i - 2$  times. In this way, we get the desired flag

$$F_i \subset F_{i+1} \subset \dots \subset F_{j-1} \subset F_j.$$

Now assume that  $i = -1$ , so that  $F_i = \emptyset$ . Since  $F_j$  is a nonempty polytope, we can find a vertex  $F_{i+1}$  in  $F_j$ . If  $j = 1$  we are home; otherwise we reason as in the previous case for the faces  $F_{i+1}$  and  $F_j$ , and again obtain the desired flag.

□



The proof of Theorem 2.3.5 works for a polyhedron whenever  $0 \leq i < j-1$ . The case  $i = -1$  requires the polyhedron to have a vertex, i.e., to be pointed (Corollary 2.3.4), which is not always possible as affine subspaces attest.

A consequence of Theorem 2.3.5 is that if a  $d$ -polytope  $P$  has a face of dimension  $k$ , then  $P$  has faces of all dimensions from  $k$  to  $d$ . Moreover,  $P$  contains a vertex (Corollary 2.3.4). We have just established the following.

**Corollary 2.3.6** *A  $d$ -polytope contains faces of every dimension from 0 to  $d-1$ .*

We denote by  $f_k$  the number of  $k$ -faces in a  $d$ -polytope  $P$ . By virtue of Corollary 2.3.6,  $f_k(P) \geq 1$  for each  $k \in [0 \dots d-1]$  and  $f_{-1}(P) = f_d(P) = 1$ . The sequence  $(f_0, \dots, f_{d-1})$  is the  $f$ -vector of  $P$ . The  $f$ -vector of a polytope plays a central role in the combinatorial theory of polytopes; see, for instance, Chapter 8.

Theorem 1.9.4 characterises faces of convex sets. We refine it next.

**Theorem 2.3.7** *Let  $P$  be a  $d$ -polytope in  $\mathbb{R}^d$  with vertex set  $V$  and let  $W \subseteq V$ . Then  $\text{conv } W$  is a face of  $P$  if and only if  $\text{conv}(V \setminus W) \cap \text{aff } W = \emptyset$ .*

*Proof* Let  $\text{conv } W$  be a face of  $P$ . For each vertex  $\mathbf{u} \in V \setminus W$ , the set  $P \setminus \{\mathbf{u}\}$  is convex (Theorem 1.9.4) and contains  $W$ , which yields that  $\text{conv } W \subseteq P \setminus \{\mathbf{u}\}$ . Thus  $V \setminus W \subseteq P \setminus \text{conv } W$ . Additionally, since  $\text{conv } W$  is a face of  $P$  we have that  $P \setminus \text{conv } W$  is convex (Theorem 1.9.4), which in turn yields that

$$\text{conv}(V \setminus W) \subseteq P \setminus \text{conv } W.$$

Combining this inclusion with  $\text{aff } W \cap P = \text{conv } W$  gives that

$$\text{conv}(V \setminus W) \cap \text{aff } W = \emptyset,$$

the necessity of the condition.

Suppose that  $V = \{\mathbf{v}_1, \dots, \mathbf{v}_n\}$  and  $W = \{\mathbf{v}_1, \dots, \mathbf{v}_m\}$  with  $1 \leq m < n$  and that the subset  $W$  satisfies  $\text{conv}(V \setminus W) \cap \text{aff } W = \emptyset$ . If  $W = \emptyset$  or  $V$  then  $\text{conv } W$  is an improper face of  $P$ . Suppose otherwise.

Take  $\mathbf{w} \in \text{conv } W$ , and suppose that  $\mathbf{w} = \alpha \mathbf{x} + (1 - \alpha) \mathbf{y}$  for  $\alpha \in [0, 1]$  and  $\mathbf{x}, \mathbf{y} \in P$ . Write  $\mathbf{x}$  and  $\mathbf{y}$  as a convex combination of  $V$ ; that is, find scalars  $\beta_1, \dots, \beta_n, \gamma_1, \dots, \gamma_n \geq 0$  such that

$$\sum_{i=1}^n \beta_i = \sum_{i=1}^n \gamma_i = 1$$

and

$$\mathbf{x} = \beta_1 \mathbf{v}_1 + \cdots + \beta_n \mathbf{v}_n \text{ and } \mathbf{y} = \gamma_1 \mathbf{v}_1 + \cdots + \gamma_n \mathbf{v}_n.$$

Let  $\zeta_i := \alpha\beta_i + (1 - \alpha)\gamma_i$  for each  $i \in [1 \dots n]$ . Then we have that, for each  $i \in [1 \dots n]$ ,  $\zeta_i \geq 0$  and  $\sum_{i=1}^n \zeta_i = 1$ . From these expressions of  $\mathbf{x}$  and  $\mathbf{y}$  we get that

$$\mathbf{w} = \zeta_1 \mathbf{v}_1 + \cdots + \zeta_m \mathbf{v}_m + \zeta_{m+1} \mathbf{v}_{m+1} + \cdots + \zeta_n \mathbf{v}_n. \tag{2.3.7.1}$$

Let  $\lambda := \zeta_{m+1} + \cdots + \zeta_n$ . Suppose that  $\lambda > 0$ . Then rearranging (2.3.7.1) gives that

$$\frac{1}{\lambda} \mathbf{w} - \frac{\zeta_1}{\lambda} \mathbf{v}_1 - \cdots - \frac{\zeta_m}{\lambda} \mathbf{v}_m = \frac{\zeta_{m+1}}{\lambda} \mathbf{v}_{m+1} + \cdots + \frac{\zeta_n}{\lambda} \mathbf{v}_n.$$

The right-hand side is a point in  $\text{conv } V \setminus W$  (call it  $\mathbf{z}$ ) and the left-hand side expresses  $\mathbf{z}$  as a point in  $\text{aff } W$ ; note that  $1/\lambda - \zeta_1/\lambda - \cdots - \zeta_m/\lambda = 1$ . This contradicts the hypothesis  $\text{conv}(V \setminus W) \cap \text{aff } W = \emptyset$ . Thus  $\lambda = 0$ , which yields that  $\zeta_i = 0$  for each  $i \in [m + 1 \dots n]$ . The equalities  $\zeta_i = 0$  for each  $i \in [m + 1 \dots n]$  imply the equalities  $\beta_i = 0$  and  $\gamma_i = 0$ , for each  $i \in [m + 1 \dots n]$ . Hence  $\mathbf{x}$  and  $\mathbf{y}$  are both in  $\text{conv } W$ , and so  $\text{conv } W$  is a face of  $P$  by (1.9.1).  $\square$

### Face Lattices

A relation  $\leq$  on a nonempty set  $\mathcal{L}$  is a *partial order* if it is *reflexive*: for every  $x \in \mathcal{L}, x \leq x$ ; *antisymmetric*: for every  $x, y \in \mathcal{L}, x \leq y$ ; and  $y \leq x$  imply that  $x = y$ ; and *transitive*: for every  $x, y, z \in \mathcal{L}, x \leq y$  and  $y \leq z$  imply that  $x \leq z$ . A *partially ordered set*, or just *poset*, is a pair  $(\mathcal{L}, \leq)$  consisting of a nonempty set  $\mathcal{L}$  and a partial order  $\leq$ ; we write just  $\mathcal{L}$  instead of  $(\mathcal{L}, \leq)$  when the relation is clear from the context. Two elements  $x$  and  $y$  are said to be *related* or *comparable* if  $x \leq y$  or  $y \leq x$ ; otherwise they are *unrelated* or *incomparable*.

A poset  $(\mathcal{L}, \leq)$  is *finite* if the set  $\mathcal{L}$  is finite. The *Boolean poset*  $B_n$ , for some  $n$ , is a basic example of a finite poset; it consists of all subsets of a set of  $n$  elements, an *n-set* for short, ordered by inclusion.

A poset under which every two elements are comparable is a *linear order*. Any subset of a poset  $\mathcal{L}$  is itself a poset, with the partial order induced from  $\mathcal{L}$ . A linearly ordered subset of  $\mathcal{L}$  is a *chain*, whose *length* is the number of elements minus one. An *antichain* is a set of pairwise incomparable elements in  $\mathcal{L}$ .

Two posets  $\mathcal{L}$  and  $\mathcal{L}'$  are *isomorphic* if there is an order-preserving bijection  $\sigma$  from  $\mathcal{L}$  to  $\mathcal{L}'$ : for all  $x, y \in \mathcal{L}, x \leq y$  is in  $\mathcal{L}$  if and only if  $\sigma(x) \leq \sigma(y)$  is in  $\mathcal{L}'$ .

A poset is *bounded* if it contains both a unique maximal element 1 and a unique minimal element 0. It is *graded* if it is bounded and every maximal chain has the same length. A poset is a *lattice*  $\mathcal{L}$  if (i) it is bounded, (ii) every pair of elements  $x$  and  $y$  has a unique minimal upper bound, called the *join* of  $x$  and  $y$ , and (iii) every pair of elements has a unique maximal lower bound, called the *meet* of  $x$  and  $y$ . In a graded lattice  $\mathcal{L}$ , the minimal elements in  $\mathcal{L} \setminus \{0\}$  are called *atoms* while the maximal elements in  $\mathcal{L} \setminus \{1\}$  are *coatoms*. A graded lattice is *atomic* if every element is a join of atoms and is *coatomic* if every element is a meet of coatoms.

Our interest in posets and lattices stems from the next definition.

**Definition 2.3.8** (Face lattice of a polytope) The *face lattice* of a polytope  $P$  is the lattice  $\mathcal{L}(P)$  of all faces of the polytope, partially ordered by inclusion.

We represent a finite poset  $\mathcal{L}$  by a *Hasse diagram*. Each element of  $\mathcal{L}$  is represented by a distinct point so that whenever  $x \leq y$  the point representing  $x$  is drawn lower than the point representing  $y$ . The face lattice of 3-cube is depicted in Fig. 2.3.2. The empty face is the minimal element and is placed at

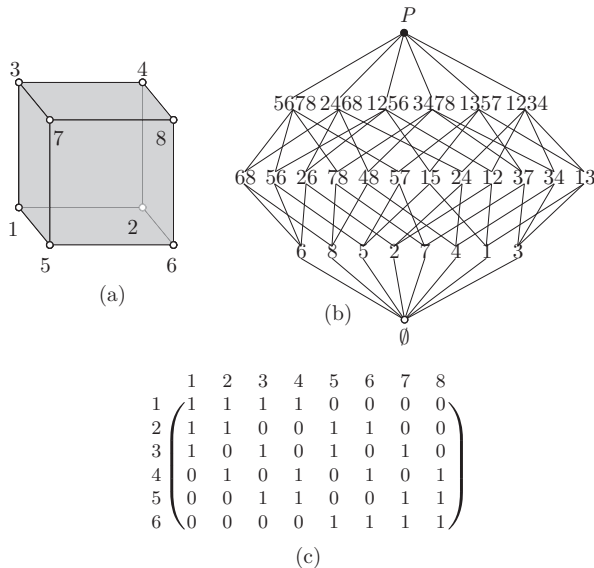

Figure 2.3.2 The face lattice of a 3-cube. (a) A 3-cube with the vertices labelled. The label of each face consists of the vertices contained in it. (b) A Hasse diagram encoding the face lattice of the 3-cube  $P$ . (c) A facet-vertex incidence matrix encoding the face lattice of the 3-cube.

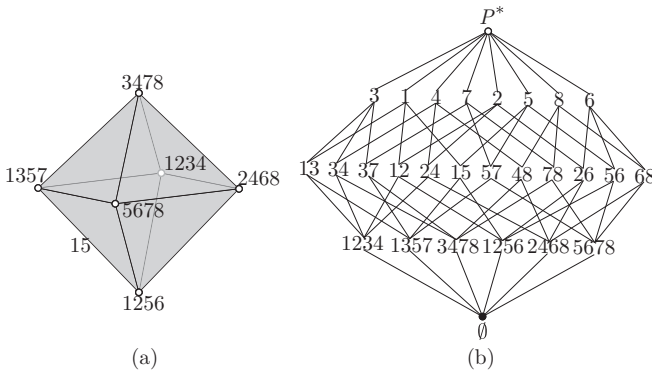

Figure 2.3.3 The face lattice of a 3-crosspolytope. (a) A 3-crosspolytope with the vertices labelled. The label of each face consists of the facets that contain it. For example, the vertex 1256 is contained in the facets 1, 2, 5, 6, and the edge 15 is contained in the facets 1, 5 and contains the vertices 1256 and 1357. (b) A Hasse diagram encoding the face lattice of the 3-crosspolytope  $P^*$ .

level  $-1$ ; the vertices are at level 0, the edges at level 1, the 2-faces at level 2, and the polytope at level 3.

Let  $(\mathcal{L}, \leq)$  be a lattice and let  $\mathcal{L}'$  be a nonempty subset of  $\mathcal{L}$ . Then the partial order  $\leq$  on  $\mathcal{L}$  induces a partial order on  $\mathcal{L}'$ . The poset  $(\mathcal{L}', \leq)$  is a *sublattice* of  $(\mathcal{L}, \leq)$  if, for every two elements  $x$  and  $y$  of  $\mathcal{L}'$ , the join and meet of  $x$  and  $y$  are both in  $\mathcal{L}'$ . The poset  $\mathcal{L}' := \{6, 68, 56, 26, 5678, 2468, 1256, P\}$  in Fig. 2.3.2(b) with the inherited partial order is a sublattice of the face lattice of the 3-cube.

The *opposite poset*  $\mathcal{L}^*$  of a poset  $\mathcal{L}$  is a poset with the same underlying set  $\mathcal{L}$  and relation  $\leq$ , and where  $x \leq y$  is in  $\mathcal{L}^*$  if and only if  $y \leq x$  is in  $\mathcal{L}$ . As we will see in Corollary 2.4.11, the opposite of the face lattice of a polytope  $P$  is the face lattice of the dual polytope  $P^*$  of  $P$ . Figure 2.3.3 shows the face lattice  $\mathcal{L}(P^*)$  of the 3-crosspolytope  $P^*$  as the opposite of the face lattice  $\mathcal{L}(P)$  of the 3-cube  $P$ ; the face lattice  $\mathcal{L}(P)$  has been rotated  $180^\circ$  to obtain  $\mathcal{L}(P^*)$ .

An *antiisomorphism* from a poset  $(\mathcal{L}, \leq)$  to a poset  $(\mathcal{L}', \leq)$  is an order-reversing bijection  $\psi$  from  $\mathcal{L}$  to  $\mathcal{L}'$ : for all  $x, y \in \mathcal{L}$ ,  $x \leq y$  is in  $\mathcal{L}$  if and only if  $\psi(x) \geq \psi(y)$ . If there is an antiisomorphism between two posets, we say that the posets are *antiisomorphic*. A lattice and its opposite lattice are antiisomorphic.

A *facet-vertex incidence matrix* of a polytope encodes its face lattice in a more efficient way than a Hasse diagram. Each row of the matrix represents a facet, each column a vertex, and the entry  $(i, j)$  has a 1 if the facet  $i$  contains the vertex  $j$  and 0 otherwise. Figure 2.3.2(c) depicts a

facet-vertex incidence matrix, where the facet 1234 has label 1, the facet 1256 has label 2, the facet 1357 has label 3, the facet 2468 has label 4, the facet 3478 has label 5, and the facet 5678 has label 6. The other faces of the polytope can be readily determined from this incidence by virtue of Theorem 2.3.1.

**Remark 2.3.9** A set  $X$  of vertices of  $P$  forms a proper face if and only if no vertex in  $\mathcal{V}(P) \setminus X$  is contained in the intersection of all the facets that contain  $X$ .

We illustrate Remark 2.3.9. The set  $X := \{7, 8\}$  is a face of the 3-cube; it is contained in the facets 5678 and 3478 whose intersection is precisely 78. However, the set  $X' := \{6, 7\}$  is not a face; it is contained only in the facet 5678, but there are other vertices in the facet.

Next we gather the main properties of face lattices of polytopes.

**Theorem 2.3.10** *Let  $\mathcal{L}$  be the face lattice of a polytope.*

- (i) *The elements 0 and 1 correspond to the empty face and the polytope, respectively.*
- (ii) *The minimal elements in  $\mathcal{L} \setminus \{0\}$ , the atoms of the lattice, are the vertices of the polytope.*
- (iii) *Every face of the polytope is a join of vertices.*
- (iv) *The maximal elements in  $\mathcal{L} \setminus \{1\}$ , the coatoms of the lattice, are the facets of the polytope.*
- (v) *Every face of the polytope is the intersection of facets.*
- (vi) *The lattice  $\mathcal{L}$  is finite, graded, atomic, and coatomic.*

Two polytopes  $P$  and  $P'$  are *combinatorially isomorphic* if their face lattices are isomorphic. We may also say that the polytopes  $P$  and  $P'$  are of the same *combinatorial type*. Unless otherwise stated we do not distinguish between combinatorially isomorphic polytopes and thus write  $P = P'$ .

We often need to embed or ‘realise’ a polytope or a combinatorial type in some space  $\mathbb{R}^d$ . A *realisation* of a polytope  $P$  with vertices  $v_1, \dots, v_n$  is a polytope  $P' := \text{conv}\{u_1, \dots, u_n\}$  where for each  $i \in [1 \dots n]$   $u_i$  is a point in  $\mathbb{R}^d$  and the mapping  $v_1 \mapsto u_1, \dots, v_n \mapsto u_n$  is an isomorphism of the face lattices of  $P$  and  $P'$ . In this way, the polytope  $P'$  is an embedding in  $\mathbb{R}^d$  of the combinatorial type of  $P$ . Researchers are often interested in the set of all realisations of a combinatorial type, which is formalised by the *realisation space of a polytope*. Realisation spaces of polytopes are the central topic of Richter-Gebert (2006).

### 2.4 Dual Polytopes

In the case of polyhedra, the definition of dual set gives rise to the *dual polyhedron*  $P^*$  of a polyhedron  $P$ . If the polyhedron happens to be a cone we will use the equivalent definition of the dual cone for the dual polyhedron. There is a recipe to go from a polyhedron that contains the origin to its dual.

**Theorem 2.4.1** *The dual of a V-polyhedron in  $\mathbb{R}^d$  that contains the origin is an H-polyhedron in  $\mathbb{R}^d$  that contains the origin, and vice versa. More precisely, let  $X := \{\mathbf{x}_1, \dots, \mathbf{x}_r\} \subseteq \mathbb{R}^d$  and  $Y := \{\mathbf{y}_1, \dots, \mathbf{y}_s\} \subseteq \mathbb{R}^d$ , let  $M$  be the matrix with rows  $\mathbf{x}_1^t, \dots, \mathbf{x}_r^t$ , and let  $N$  be the matrix with rows  $\mathbf{y}_1^t, \dots, \mathbf{y}_s^t$ . Then the following hold:*

- (i) *If  $P := \text{conv}(X \cup \{\mathbf{0}_d\}) + \text{cone } Y$  then  $P^* = \{\mathbf{z} \in \mathbb{R}^d \mid M\mathbf{z} \leq \mathbf{1}_r, N\mathbf{z} \leq \mathbf{0}_s\}$ .*
- (ii) *If instead*

$$P := \left\{ \mathbf{z} \in \mathbb{R}^d \mid \begin{pmatrix} M \\ N \end{pmatrix} \mathbf{z} \leq \begin{pmatrix} \mathbf{1}_r \\ \mathbf{0}_s \end{pmatrix} \right\} = \left\{ \mathbf{z} \in \mathbb{R}^d \mid M\mathbf{z} \leq \mathbf{1}_r, N\mathbf{z} \leq \mathbf{0}_s \right\},$$

then  $P^* = \text{conv}(X \cup \{\mathbf{0}_d\}) + \text{cone } Y$ .

*Proof* (i) Suppose that  $P := \text{conv}(X \cup \{\mathbf{0}_d\}) + \text{cone } Y$  and that  $\mathbf{w} \in P^*$ . Additionally, let

$$Q := \left\{ \mathbf{z} \in \mathbb{R}^d \mid M\mathbf{z} \leq \mathbf{1}_r, N\mathbf{z} \leq \mathbf{0}_s \right\}.$$

Since  $\mathbf{x}_1, \dots, \mathbf{x}_r \in P$  we find that  $\mathbf{w} \cdot \mathbf{x}_i \leq 1$  for  $i \in [1 \dots r]$  by Definition 1.11.1. And since  $\mathbf{y}_1, \dots, \mathbf{y}_s \in P$  and  $\text{cone } Y \subseteq P$  we find that  $\mathbf{w} \cdot \mathbf{y}_j \leq 0$  for  $j \in [1 \dots s]$  by (1.11.11). Hence  $\mathbf{w} \in Q$  and  $P^* \subseteq Q$ .

Suppose that  $\mathbf{w} \in Q$ . Take  $\mathbf{u} \in P$ . Then there exist scalars  $\alpha_1 \geq 0, \dots, \alpha_r \geq 0$  with  $\sum_{i=1}^r \alpha_i = 1$  and scalars  $\beta_1 \geq 0, \dots, \beta_s \geq 0$  for which

$$\begin{aligned} \mathbf{w} \cdot \mathbf{u} &= \mathbf{w} \cdot (\alpha_1 \mathbf{x}_1 + \dots + \alpha_r \mathbf{x}_r + \beta_1 \mathbf{y}_1 + \dots + \beta_s \mathbf{y}_s) \\ &= \alpha_1 \mathbf{w} \cdot \mathbf{x}_1 + \dots + \alpha_r \mathbf{w} \cdot \mathbf{x}_r + \beta_1 \mathbf{w} \cdot \mathbf{y}_1 + \dots + \beta_s \mathbf{w} \cdot \mathbf{y}_s \\ &\leq \alpha_1 + \dots + \alpha_r + 0 + \dots + 0 = 1. \end{aligned}$$

The last inequality follows from the definition of  $Q$ . Hence  $\mathbf{w} \in P^*$  and  $Q \subseteq P^*$ . As a consequence,  $P^* = Q$ .

(ii) Suppose that  $P$  is given as in (ii) and that  $Q := \text{conv}(X \cup \{\mathbf{0}\}) + \text{cone } Y$ . By (i) we have that  $Q^* = P$ . And from  $Q^{**} = Q$  (Theorem 1.11.7) it follows that  $P^* = Q^{**} = Q$ , as desired. □

In the particular case of cones, Theorem 2.4.1 reduces to the following.

**Theorem 2.4.2** *The dual cone of a V-cone in  $\mathbb{R}^d$  is an H-cone in  $\mathbb{R}^d$ , and vice versa. More precisely,*

- (i) *if  $C := \text{cone}\{\mathbf{x}_1, \dots, \mathbf{x}_n\}$  then, letting  $M \in \mathbb{R}^{n \times d}$  be the matrix with rows  $\mathbf{x}_1^t, \dots, \mathbf{x}_n^t$ , we have that  $C^* = \{\mathbf{y} \in \mathbb{R}^d \mid M\mathbf{y} \leq \mathbf{0}_n\}$ ; and*
- (ii) *if  $C := P(M, \mathbf{0}_n)$  where  $M$  is a  $n \times d$  matrix with rows  $\mathbf{x}_1^t, \dots, \mathbf{x}_n^t$ , then  $C^* = \text{cone}\{\mathbf{x}_1, \dots, \mathbf{x}_n\}$ .*

### Polytopes

If a polytope  $P$  in  $\mathbb{R}^d$  contains the origin in its interior then the dual set  $P^*$  of  $P$  is a polyhedron by Theorem 2.4.1 and is bounded by Theorem 1.11.8. Thus  $P^*$  is a polytope (Theorem 2.2.3), and so we call it the *dual polytope* of  $P$ . The bounded case of Theorem 2.4.1 gives a recipe to go from a polytope that contains the origin in its interior to its dual; this is summarised next.

**Theorem 2.4.3** *Let  $X := \{\mathbf{x}_1, \dots, \mathbf{x}_r\} \subseteq \mathbb{R}^d$  and let  $M$  be the matrix with rows  $\mathbf{x}_1^t, \dots, \mathbf{x}_r^t$ . Then the following hold:*

- (i) *If  $P := \text{conv } X$  and  $P$  contains the origin in its interior, then*

$$P^* = \left\{ \mathbf{z} \in \mathbb{R}^d \mid M\mathbf{z} \leq \mathbf{1}_r \right\}$$

*and  $P^*$  contains the origin in its interior.*

- (ii) *If instead  $P := \{\mathbf{z} \in \mathbb{R}^d \mid M\mathbf{z} \leq \mathbf{1}_r\}$  and  $P$  contains the origin in its interior then  $P^* = \text{conv } X$  and  $P^*$  contains the origin in its interior.*
- (iii) *Suppose that  $P := \text{conv } X$  contains the origin in its interior. Then  $\mathcal{V}(P) = X$  if and only if  $\{\mathbf{z} \in \mathbb{R}^d \mid M\mathbf{z} \leq \mathbf{1}_r\}$  is an irredundant H-description of  $P^*$ .*

*Proof* Parts (i) and (ii) are the bounded case of Theorem 2.4.1. We prove (iii). Since  $\mathbf{0}_d \in \text{int } P$ , we have that  $\#X \geq 2$ . We prove the contrapositive of both directions.

Suppose that  $\mathcal{V}(P) \subset X$ , say  $\mathbf{x}_\ell \notin \mathcal{V}(P)$ , and let

$$P_\ell := \text{conv}(X \setminus \{\mathbf{x}_\ell\}) \text{ and } Q_\ell := \{\mathbf{z} \in \mathbb{R}^d \mid M_\ell \mathbf{z} \leq \mathbf{1}_{r-1}\},$$

where  $M_\ell$  is obtained from  $M$  by removing the row  $\mathbf{x}_\ell^t$ . Because  $\mathbf{0}_d \in \text{int } P$ , it follows that  $\mathbf{0}_d \in \text{int } P_\ell$ , and so Part (i) yields that  $P_\ell^* = Q_\ell$ . Besides, Minkowski–Krein–Milman’s theorem (1.9.11) ensures that  $P = \text{conv } \mathcal{V}(P)$ , and so  $P = P_\ell$ . From  $P = P_\ell$  it follows that  $P^* = P_\ell^*$ , which implies that the H-description  $\{\mathbf{z} \in \mathbb{R}^d \mid M\mathbf{z} \leq \mathbf{1}_r\}$  of  $P^*$  is redundant.

Suppose that the  $H$ -description  $\{z \in \mathbb{R}^d \mid Mz \leq \mathbf{1}_r\}$  of  $P^*$  is redundant, say

$$P^* = \left\{ z \in \mathbb{R}^d \mid M_\ell z \leq \mathbf{1}_{r-1} \right\}$$

where  $M_\ell$  is obtained from  $M$  by removing the row  $\mathbf{x}_\ell^t$ . Then  $\mathbf{0}_d \in \text{int } P^*$ . Let  $P_\ell := \text{conv}(X \setminus \{\mathbf{x}_\ell\})$ . Part (ii) yields that  $P^{**} = P_\ell$ . The polytope  $P$  contains the origin in its interior, which implies that  $P = P^{**}$  (Corollary 1.11.9); that is,  $P = P_\ell$ . Again by Minkowski–Krein–Milman’s theorem (1.9.11), we have that  $P = P_\ell = \text{conv } \mathcal{V}(P)$ , resulting in  $\mathcal{V}(P) \subset X$ .  $\square$

**Example 2.4.4** We find the dual of a  $d$ -cube  $Q(d)$  that is given as an  $H$ -polytope (Example 2.1.6) in two different ways: (i) reasoning as in Example 1.11.4 and (ii) following the recipe of Theorem 2.4.3. An  $H$ -description of  $Q(d)$  is as follows:

$$\begin{aligned} Q(d) &= \{(x_1, \dots, x_d)^t \mid |x_1| \leq 1, \dots, |x_d| \leq 1\} \\ &= \left\{ z \in \mathbb{R}^d \mid \begin{pmatrix} \mathbf{e}_1^t \\ -\mathbf{e}_1^t \\ \vdots \\ \mathbf{e}_d^t \\ -\mathbf{e}_d^t \end{pmatrix} z \leq \mathbf{1}_{2d} \right\}. \end{aligned} \tag{2.4.4.1}$$

(i) Each point  $\mathbf{y} := (y_1, \dots, y_d)^t$  of  $Q(d)^*$  satisfies  $\mathbf{y} \cdot \mathbf{x} \leq 1$  for every point  $\mathbf{x} \in Q(d)$  (Definition 1.11.1), and, in particular, for the point  $\mathbf{x}_y := (\text{sign } y_1, \dots, \text{sign } y_d)^t$  of  $Q(d)$ . Here,  $\text{sign } y$  denotes the sign function:  $\text{sign } y = -1$  if  $y < 0$ ,  $\text{sign } y = 0$  if  $y = 0$ , and  $\text{sign } y = 1$  if  $y > 0$ . Then

$$\mathbf{y} \cdot \mathbf{x}_y = y_1 \text{sign } y_1 + \dots + y_d \text{sign } y_d = |y_1| + \dots + |y_d| \leq 1.$$

Hence

$$Q(d)^* \subseteq \{(z_1, \dots, z_d)^t \in \mathbb{R}^d \mid |z_1| + \dots + |z_d| \leq 1\}.$$

Take  $\mathbf{z} \in \mathbb{R}^d$  such that  $|z_1| + \dots + |z_d| \leq 1$ . Then, for every point  $\mathbf{x}$  in  $Q(d)$ , we have that

$$\begin{aligned} \mathbf{z} \cdot \mathbf{x} &= z_1 x_1 + \dots + z_d x_d \leq |z_1| |x_1| + \dots + |z_d| |x_d| \\ &\leq |z_1| + \dots + |z_d| \leq 1. \end{aligned}$$



Hence  $z \in Q(d)^*$ , and

$$Q(d)^* = \left\{ (z_1, \dots, z_d)^t \in \mathbb{R}^d \mid |z_1| + \dots + |z_d| \leq 1 \right\} \\ = \left\{ z \in \mathbb{R}^d \mid \begin{pmatrix} 1 & 1 & \dots & 1 & 1 \\ -1 & 1 & \dots & 1 & 1 \\ & & \dots & & \\ -1 & -1 & \dots & -1 & -1 \end{pmatrix} z \leq \mathbf{1}_{2d} \right\}.$$

(ii) Applying the recipe of Theorem 2.4.3 to (2.4.4.1) we get that

$$Q(d)^* = \text{conv} \{e_1, -e_1, \dots, e_d, -e_d\}.$$

The polytope  $Q(d)^*$  is known as a  $d$ -crosspolytope and is denoted by  $I(d)$ .

### Dimension of the Dual Polytope

The lineality space of a polyhedron is closely linked to the dimension of the dual polyhedron. The next proposition gives the relevant result.

**Proposition 2.4.5** *If  $P$  is a polyhedron in  $\mathbb{R}^d$  that contains the origin, then*

- (i) *aff  $P^*$  is the orthogonal complement of lineal  $P$ ,*
- (ii)  *$\dim P^* = d - \dim(\text{lineal } P)$ , and*
- (iii)  *$\dim P = d - \dim(\text{lineal } P^*)$ .*

*Proof* (i) Suppose that  $P$  is given as the  $H$ -polyhedron

$$P = \left\{ z \in \mathbb{R}^d \mid \begin{pmatrix} M \\ N \end{pmatrix} z \leq \begin{pmatrix} \mathbf{1}_r \\ \mathbf{0}_s \end{pmatrix} \right\} = \left\{ z \in \mathbb{R}^d \mid Az \leq \begin{pmatrix} \mathbf{1}_r \\ \mathbf{0}_s \end{pmatrix} \right\},$$

where  $M$  is the matrix in  $\mathbb{R}^{r \times d}$  with rows  $x_1^t, \dots, x_r^t$ ,  $N$  is the matrix in  $\mathbb{R}^{s \times d}$  with rows  $y_1^t, \dots, y_s^t$ , and  $A$  is the matrix in  $\mathbb{R}^{(r+s) \times d}$  with rows  $x_1^t, \dots, x_r^t, y_1^t, \dots, y_s^t$ .

By Theorem 2.4.1, the dual  $P^*$  of  $P$  can be written as

$$P^* = \text{conv}(X \cup \{\mathbf{0}_d\}) + \text{cone } Y,$$

where  $X = \{x_1, \dots, x_r\}$  and  $Y = \{y_1, \dots, y_s\}$ . Since  $\mathbf{0} \in P^*$ , we have that the affine hull of  $P^*$  coincides with its linear hull. As a consequence, we further have that  $\text{aff } P^*$  is linearly spanned by  $X \cup Y$  and coincides with the row space of  $A$  (see Example 1.1.6).

According to Theorem 2.1.9,  $\text{lineal } P = \{z \in \mathbb{R}^d \mid Az = \mathbf{0}_{r+s}\}$ ; that is,  $\text{lineal } P$  is the nullspace of  $A$ . The row space of  $A$  is the orthogonal

complement of its nullspace by the nullity–rank theorem (Problem 1.12.5), and therefore

$$\text{aff } P^* = (\text{lineal } P)^\perp,$$

as desired.

(ii) The nullity–rank theorem applied to (i) gives (ii).

(iii) The polyhedron  $P$  contains the origin, and so  $P^{**} = P$  by Theorem 1.11.7. Moreover,  $P^*$  is another polyhedron in  $\mathbb{R}^d$  that contains the origin (Theorem 2.4.1). Part (iii) is confirmed by applying (ii) to  $P^*$ .  $\square$

We remark that Proposition 2.4.5 remains true in the more general case of  $P$  being a closed convex set in  $\mathbb{R}^d$  that contains the origin. The subsequent corollary of Proposition 2.4.5 follows at once.

**Corollary 2.4.6** *If  $P$  is a pointed, full-dimensional polyhedron in  $\mathbb{R}^d$  that contains the origin, then so is the dual of  $P$ .*

*Proof* By Theorem 2.4.1, the dual  $P^*$  of  $P$  is a polyhedron that contains the origin.

If  $P$  is pointed, then  $\text{lineal } P = \{\mathbf{0}\}$  (Section 1.10). By Proposition 2.4.5, this implies that  $\dim P^* = d$ . Since  $P$  is full-dimensional, Proposition 2.4.5 again yields that  $\text{lineal } P^* = \{\mathbf{0}\}$ , which is equivalent to saying that  $P^*$  is pointed. Hence  $P^*$  is pointed and full-dimensional.

Finally, the dual polyhedron contains the origin (Proposition 1.11.3), and so the corollary follows.  $\square$

The subsequent statement is a consequence of Theorem 2.4.3 and Corollary 2.4.6.

**Proposition 2.4.7** *If a  $d$ -polytope contains the origin in its interior, then its dual is also a  $d$ -polytope that contains the origin in its interior.*

### Conjugate Faces

Let  $P$  be a polytope that contains the origin in its interior. We next explore the relationship between the faces of  $P$  and the faces of the dual polytope  $P^*$  of  $P$ . For a face  $F$  of  $P$ , we define the set

$$F^\Delta := \{y \in P^* \mid y \cdot x = 1 \text{ for every } x \in F\} = \bigcap_{x \in F} (P^* \cap H(x, 1)). \quad (2.4.8)$$

For exposed faces  $I$  and  $F$  of  $P$ , Definition (2.4.8) gives that

$$\text{if } I \text{ is a face of } F \text{ and } F \text{ is a face of } P \text{ then } I^\Delta \supseteq F^\Delta. \quad (2.4.9)$$

The next theorem motivates the definition (2.4.8).

**Theorem 2.4.10** *Let  $P \subseteq \mathbb{R}^d$  be a  $d$ -polytope that contains the origin in its interior. Suppose that  $F$  is a proper face of  $P$ . Then the following hold:*

- (i)  $F^\Delta$  is a proper face of the dual polytope  $P^*$ .
- (ii) A point  $\mathbf{a}$  is in  $F$  if and only if  $H(\mathbf{a}, 1)$  is a hyperplane supporting  $P^*$  and containing  $F^\Delta$ .
- (iii) The point  $\mathbf{a}$  is in  $\text{rint } F$  if and only if  $F^\Delta = P^* \cap H(\mathbf{a}, 1)$ .
- (iv)  $F^{\Delta\Delta} = F$ .
- (v) There exists an antiisomorphism  $\psi$  from the face lattice  $\mathcal{L}(P)$  of  $P$  to the face lattice  $\mathcal{L}(P^*)$  of  $P^*$  that sends each face  $F$  of  $P$  onto the face  $F^\Delta$  of  $P^*$ .

*Proof* The proofs of (i)–(iv) follow from Brøndsted (1983, thms. 6.6, 6.7). Part (v) is a direct consequence of (i), (iv), and (2.4.9).  $\square$

Let  $P$  be a  $d$ -polytope that contains the origin in its interior. For an exposed face  $F$  of  $P$ , by virtue of Theorem 2.4.10(i) we say that the face  $F^\Delta$  of the dual polytope  $P^*$  is the *conjugate face* of  $F$ . And by virtue of Theorem 2.4.10(iv), we have that the conjugate face of  $F^\Delta$  is  $F$ . We often say that  $F$  and  $F^\Delta$  are conjugate.

A direct consequence of Theorem 2.4.10(v) is the following.

**Corollary 2.4.11** *Let  $P \subseteq \mathbb{R}^d$  be a  $d$ -polytope that contains the origin in its interior and let  $P^*$  be the dual polytope of  $P$ . Then the face lattice  $\mathcal{L}(P^*)$  of  $P^*$  is isomorphic to the opposite lattice  $\mathcal{L}(P)^*$  of the face lattice  $\mathcal{L}(P)$  of  $P$ .*

For any  $d$ -polytope  $P$  in  $\mathbb{R}^d$ , there is a  $d$ -polytope  $Q$  in  $\mathbb{R}^d$  that contains the origin in its interior and that is combinatorially isomorphic to  $P$ ; we can obtain  $Q$  by translating  $P$  or changing the coordinates of  $P$ . As a consequence, the face lattice of  $P$  is isomorphic to the face lattice of  $Q$  and antiisomorphic to the face lattice of  $Q^*$ . The existence of  $Q$  allows us to define the ‘dual polytope’ for any polytope, not just for a polytope that contains the origin in its interior. We say that a polytope  $P^*$  is the (combinatorial) *dual polytope* of  $P$  if the face lattice of  $P^*$  is antiisomorphic to the face lattice of  $P$ .

We now present a relation between the dimensions of  $F$  and  $F^\Delta$ .

**Theorem 2.4.12** *Let  $P \subseteq \mathbb{R}^d$  be a  $d$ -polytope that contains the origin in its interior, and let  $P^*$  be the dual polytope of  $P$ . If  $F$  and  $F^\Delta$  are conjugate faces of  $P$  and  $P^*$ , respectively, then  $\dim F + \dim F^\Delta = d - 1$ .*

*Proof* According to Theorem 2.3.5, every  $k$ -face  $F_k$  of  $P$  is part of a complete flag

$$\emptyset = F_{-1} \subset F_0 \subset \cdots \subset F_k \subset \cdots \subset F_{d-1} \subset F_d = P \tag{2.4.12.1}$$

of faces of  $P$  such that  $\dim F_i = i$ , for each  $i \in [-1 \dots d]$ . By Theorem 2.4.10(v), computing the conjugate of every face in (2.4.12.1) yields a new complete flag

$$\emptyset = F_d^\Delta \subset F_{d-1}^\Delta \subset \cdots \subset F_k^\Delta \subset \cdots \subset F_0^\Delta \subset F_{-1}^\Delta = P^*$$

of faces of  $P^*$  such that  $\dim F_i^\Delta > \dim F_{i+1}^\Delta$ , for each  $i \in [-1 \dots d - 1]$ . Since  $P^*$  is also a  $d$ -polytope (Proposition 2.4.7), we must have that  $\dim F_i^\Delta = \dim F_{i+1}^\Delta + 1$ , for each  $i \in [-1 \dots d - 1]$ , and that  $\dim F_d^\Delta = -1$ . It follows that  $\dim F_i + \dim F_i^\Delta = d - 1$  for each  $i \in [-1 \dots d]$ , as desired.  $\square$

Some results related to the facial structure of a polytope are easier to prove if duality is invoked. We give four examples.

**Theorem 2.4.13** *A  $d$ -polytope has at least  $d + 1$  facets.*

*Proof* Without loss of generality, suppose that  $P$  is a  $d$ -polytope in  $\mathbb{R}^d$  that contains the origin in its interior. The dual polytope  $P^*$  of  $P$  is another  $d$ -polytope that contains the origin in its interior (Proposition 2.4.7). Moreover,  $P^*$  can be expressed as  $\text{conv } \mathcal{V}(P^*)$  by Minkowski–Krein–Milman’s theorem (1.9.11). Since  $P^*$  is  $d$ -dimensional, the number of affinely independent points in  $P^*$  is  $d + 1$  and thus  $v(P^*) \geq d + 1$ . By Corollary 2.4.11, the number of facets of  $P$  is  $v(P^*)$ , and is at least  $d + 1$ .  $\square$

**Theorem 2.4.14** *A vertex of a  $d$ -polytope  $P$  in  $\mathbb{R}^d$  is contained in at least  $d$  edges of  $P$ .*

*Proof* Without loss of generality, suppose that  $P$  contains the origin in its interior. Let  $\mathbf{v}$  be a vertex of  $P$  and let  $\psi$  be an antiisomorphism from  $\mathcal{L}(P)$  to  $\mathcal{L}(P^*)$ . From Theorem 2.4.12 it follows that  $\dim \psi(\mathbf{v}) = d - 1$ , and from Theorem 2.4.13 it follows that the number of  $(d - 2)$ -faces in  $\psi(\mathbf{v})$  is at least  $d$ , say  $R_1, \dots, R_d$ . Hence  $\psi^{-1}(R_1), \dots, \psi^{-1}(R_d)$  are all edges of  $P$  containing  $\mathbf{v}$  (Corollary 2.4.11), concluding the proof of the theorem.  $\square$

Theorem 2.4.14 yields a useful inequality between  $f_0$  and  $f_1$  and, by duality, between  $f_{d-2}$  and  $f_{d-1}$ .

**Corollary 2.4.15** *If  $P$  is a  $d$ -polytope, then*

$$2f_1(P) \geq df_0(P), \quad 2f_{d-2}(P) \geq df_{d-1}(P).$$

*Proof* Each edge of  $P$  contains precisely two vertices and each vertex is incident with at least  $d$  edges by Theorem 2.4.14. Hence  $2f_1(P) \geq df_0(P)$ .

By applying this inequality to the dual polytope  $P^*$  of  $P$ , we get that  $2f_1(P^*) \geq df_0(P^*)$ . Hence  $2f_{d-2}(P) \geq df_{d-1}(P)$ .  $\square$

**Theorem 2.4.16** *Let  $P \subseteq \mathbb{R}^d$  be a  $d$ -polytope. For  $-1 \leq k < h \leq d-1$ , each  $k$ -face  $F$  of  $P$  is the intersection of at least  $h-k+1$   $h$ -faces of  $P$  that contain it. In the particular case  $k = d-2$ ,  $F$  is the intersection of exactly two facets of  $P$ .*

*Proof* The result is true for  $d = 2$  and every  $-1 \leq k < h \leq 1$ . Thus, assume that  $d \geq 3$  and the statement is true for every  $(d-1)$ -polytope and every pair of numbers  $k, h$  satisfying  $-1 \leq k < h \leq d-2$ .

Without loss of generality, suppose that  $P$  is a  $d$ -polytope that contains the origin in its interior. We first prove the result for  $h = d-1$  and every  $-1 \leq k < h$ . Let  $\psi$  be an antiisomorphism from  $\mathcal{L}(P)$  to  $\mathcal{L}(P^*)$ . Because  $\dim F = k$ , from Theorem 2.4.12 it follows that  $\dim \psi(F) = d-1-k$ , which amounts to  $\psi(F)$  having at least  $d-k$  vertices, say  $v_1, \dots, v_{d-k}$ ; in the case  $k = d-2$ ,  $\psi(F)$  is an edge and has exactly two vertices. By Theorem 2.4.10, the faces  $\psi^{-1}(v_1), \dots, \psi^{-1}(v_{d-k})$  of  $P$  are all facets that contain  $F$ . We know from Theorem 2.3.1 that the face  $F$  is the intersection of the facets of  $P$  containing it. Therefore, there are at least  $d-k$  such facets. This settles the case  $h = d-1$ .

We now pick a facet  $J$  of  $P$  containing  $F$ . By the induction hypothesis,  $F$  is the intersection of at least  $h-k+1$   $h$ -faces of  $J$  that contain it for every  $-1 \leq k < h \leq d-2$ . Each face of  $J$  is a face of  $P$  and so the statement follows for  $h \leq d-2$  as well.  $\square$

## 2.5 Preprocessing

While most of the proofs in this book live entirely in an affine space, it is sometimes convenient to enlarge the affine space into a real projective space, preprocess our objects, and then return to the affine world with simpler objects.

We digress temporarily to introduce embeddings of affine spaces into projective spaces.

### Embedding Affine Spaces into Projective Spaces

We slightly vary the model of  $\mathbb{P}(\mathbb{R}^{d+1})$  presented in Section 1.3 so that it now completes a  $d$ -dimensional affine space  $H$  by adding the points contained in the direction of  $H$ . In this new model we keep the close relation between  $\mathbb{P}(\mathbb{R}^{d+1})$  and  $\mathbb{R}^{d+1}$ , which has proven very useful. The main idea has its

seeds in the embedding of an affine space into a linear space, as discussed in Section 1.2.

We first embed the  $d$ -dimensional affine space  $\mathbb{A}^d$  into  $\mathbb{R}^{d+1}$  by associating  $\mathbb{A}^d$  with the nonlinear hyperplane

$$H := \left\{ (x_1, \dots, x_{d+1})^t \in \mathbb{R}^{d+1} \mid x_{d+1} = 1 \right\}.$$

In the embedding of  $\mathbb{A}^d$  into  $\mathbb{R}^{d+1}$  described in Section 1.2, the linear hyperplane

$$H_\infty := \left\{ (x_1, \dots, x_{d+1})^t \in \mathbb{R}^{d+1} \mid x_{d+1} = 0 \right\}$$

parallel to  $H$  plays the role of the direction of  $H$ . In our new model of  $\mathbb{P}^d$ , the hyperplane  $H_\infty$  will also play an important role.

To every line  $p(\mathbf{x})$  in  $\mathbb{R}^{d+1}$  that is not contained in the linear hyperplane  $H_\infty$  we assign the unique point  $(\alpha_1, \dots, \alpha_d, 1)^t$  in the intersection of  $p(\mathbf{x})$  with  $H$ . And to every line  $p(\mathbf{x})$  in  $H_\infty$  we assign the homogeneous coordinates of  $p(\mathbf{x})$ , namely  $(\alpha_1 : \dots : \alpha_d : 0)$ ; we call the lines  $p(\mathbf{x})$  in  $H_\infty$  *points at infinity*. A point at infinity in  $H_\infty$  can be thought of as the asymptotic direction of all lines in  $H$  parallel to the point. The hyperplane  $H_\infty$  is often called the *hyperplane at infinity*.

The projective points therefore decompose into two types: those represented by an affine point  $(\alpha_1, \dots, \alpha_d, 1)^t$  in  $H$ , which can also be seen as a vector of  $\mathbb{R}^{d+1}$ , and those represented by the lines in  $H_\infty$  that pass through the origin, or equivalently, by homogeneous coordinates of the form  $(\alpha_1 : \dots : \alpha_d : 0)$ . The hyperplane  $H_\infty$  defines a  $(d - 1)$ -dimensional projective subspace of  $\mathbb{P}^d$ : it is the set of lines through the origin in the linear subspace  $H_\infty$ . The subsequent decompositions of  $\mathbb{P}^d$  follow at once (see Fig. 1.3.1(b)):

$$\mathbb{P}^d = H \cup H_\infty = \mathbb{A}^d \cup \mathbb{P}^{d-1}. \tag{2.5.1}$$

It is instructive to compare Fig. 1.2.1(b) with Fig. 1.3.1(b).

As before, any  $k$ -dimensional linear subspace  $L$  of  $\mathbb{R}^{d+1}$  defines a  $(k - 1)$ -dimensional projective subspace whose projective points are either the affine points in  $L \cap H$  or the points at infinity in  $L \cap H_\infty$ .

In this embedding of  $\mathbb{A}^d$  into  $\mathbb{P}^d$ , the space  $\mathbb{P}^d$  is the *projective closure* or *projective completion* of  $\mathbb{A}^d$ . We can naturally complete an affine subspace  $A$  of  $H$ . Consider the direction  $\vec{A}$  of  $A$  and the homogenisation  $\hat{A}$  of  $A$  (see Section 1.2). Then  $\hat{A}$  is a linear subspace of  $\mathbb{R}^{d+1}$  that contains both  $A$  and  $\vec{A}$ . The *projective closure* of  $A$  is the projective space  $\mathbb{P}(\hat{A})$ ; that is, it is the projective space defined as  $\mathbb{P}(\vec{A})$  together with the set  $p(A)$  of lines that pass through the origin and are spanned by the points of  $A$ . The elements of  $\mathbb{P}(\hat{A})$

are the *points of infinity* of  $\mathbb{P}(\widehat{A})$ . We obtain a decomposition of  $\mathbb{P}(\widehat{A})$  similar to that in (2.5.1):

$$\mathbb{P}(\widehat{A}) = A \cup \mathbb{P}(\vec{A}).$$

If the affine space  $A$  is defined by the system of linear equations

$$\begin{cases} \alpha_{1,1}x_1 + \cdots + \alpha_{1,d}x_d + b_1 & = & 0 \\ & \vdots & \\ \alpha_{n,1}x_1 + \cdots + \alpha_{n,d}x_d + b_n & = & 0, \end{cases}$$

then its closure is defined by the system of homogeneous linear equations

$$\begin{cases} \alpha_{1,1}x_1 + \cdots + \alpha_{1,d}x_d + b_1x_{d+1} & = & 0 \\ & \vdots & \\ \alpha_{n,1}x_1 + \cdots + \alpha_{n,d}x_d + b_nx_{d+1} & = & 0. \end{cases}$$

### Scheme for Preprocessing Affine Objects

The idea goes as follows. There is an affine object  $P$  (in most instances, a polytope) embedded in a  $d$ -dimensional affine space  $H^e$ . Projectively complete  $H^e$  by adding the hyperplane at infinity  $H_\infty^e$ . Consider another nonlinear hyperplane  $H^p$  that is nonparallel to  $H^e$  and denote by  $H_\infty^p$  its corresponding hyperplane at infinity. Assume that the object  $P$  lies in  $H^e$ , in the open halfspace defined by  $H_\infty^p$  and containing  $H^p$ ; following Ziegler (1995, sec. 2.6), if  $P$  is positioned as described, we say that the hyperplane  $H^p$  is *admissible* for  $P$ . In this case, the hyperplane  $H^p$  intersects every line passing through the origin and a point of  $P$  (Fig. 2.5.1).

With the projective completions of  $H^e$  and  $H^p$  in place so that the hyperplane  $H^p$  is admissible for  $P$ , we then describe a projective transformation  $\zeta: \mathbb{P}(\mathbb{R}^{d+1}) \rightarrow \mathbb{P}(\mathbb{R}^{d+1})$  mapping  $P$  onto a ‘deformed’ object  $P'$  in  $H^p$ ; see Section 1.4 for information on projective maps. The affine space  $H^p$  and the object  $P'$  are subsequently used instead of  $H^e$  and  $P$ . Essentially, the affine object  $P'$  is geometrically realised by the intersection of  $H^p$  and a projective object  $p(P)$  consisting of the lines passing through the origin and through a point of  $P$ . We require that this projective transformation  $\zeta$  is *admissible* for  $P$ : no point of  $P$  lies in  $H_\infty^p$ .

Let us make our explanation concrete. Take

$$\begin{aligned}
 H^e &:= \left\{ \begin{pmatrix} \mathbf{x} \\ x_{d+1} \end{pmatrix} \mid \mathbf{x} \in \mathbb{R}^d \text{ and } x_{d+1} = 1 \right\}, \\
 H_\infty^e &:= \left\{ \begin{pmatrix} \mathbf{x} \\ x_{d+1} \end{pmatrix} \mid \mathbf{x} \in \mathbb{R}^d \text{ and } x_{d+1} = 0 \right\}, \\
 H^p &:= \left\{ \begin{pmatrix} \mathbf{x} \\ x_{d+1} \end{pmatrix} \mid \mathbf{x}, \mathbf{a} \in \mathbb{R}^d \text{ and } \mathbf{a} \cdot \mathbf{x} + a_{d+1}x_{d+1} = 1 \right\}, \\
 H_\infty^p &:= \left\{ \begin{pmatrix} \mathbf{x} \\ x_{d+1} \end{pmatrix} \mid \mathbf{x}, \mathbf{a} \in \mathbb{R}^d \text{ and } \mathbf{a} \cdot \mathbf{x} + a_{d+1}x_{d+1} = 0 \right\},
 \end{aligned}$$

so that  $H^p$  and  $H^e$  are nonparallel. Then the admissibility of the hyperplane  $H^p$  for  $P$  amounts to saying that

$$\mathbf{a} \cdot \mathbf{v} + a_{d+1}v_{d+1} > 0$$

for every point  $(\mathbf{v}, v_{d+1})^t$  of  $P$ .

We let the projective transformation  $\zeta$  be induced by the identity linear map in  $\mathbb{R}^{d+1}$  and we associate it with a perspectivity  $\varrho$  that goes from  $H^e \setminus (H^e \cap H_\infty^p)$  to  $H^p$  and is centred at  $\mathbf{0}$ . In this association, if  $\varrho(\mathbf{z}_1) = \mathbf{z}_2$  then  $\zeta(p(\mathbf{z}_1)) = p(\mathbf{z}_2)$ . An affine *perspectivity* centred at  $\mathbf{0}$  is a function between affine hyperplanes  $K$  and  $K'$  that maps a point  $\mathbf{z}$  of  $K$  to a point  $\mathbf{z}'$  of  $K'$  whenever  $\mathbf{z}, \mathbf{z}'$ , and  $\mathbf{0}$  are collinear; see Fig. 2.5.1(a).

Let the map  $\varrho$  fix the points in  $H^e \cap H^p$  and map each point in  $H^e \setminus (H^p \cup H_\infty^p)$  to the point in  $H^p$  lying on the same line through the origin. See Fig. 2.5.1(a). In formulas we get that the map acts as

$$\begin{pmatrix} \mathbf{x} \\ 1 \end{pmatrix} \in H^e \mapsto \frac{1}{\mathbf{a}\mathbf{x} + a_{d+1}} \begin{pmatrix} \mathbf{x} \\ 1 \end{pmatrix} \in H^p$$

provided  $\mathbf{a}\mathbf{x} + a_{d+1} \neq 0$ .

We extend the map  $\varrho$  via the transformation  $\zeta$  for the remaining points of  $H^e$ . Take a point  $\mathbf{y}$  in  $H^e \cap H_\infty^p$  and consider any line  $\ell^e$  in  $H^e$  through  $\mathbf{y}$  that is not contained in  $H^e \cap H_\infty^p$ . Obtain the line  $\ell^p$  in  $H^p$  that is the intersection of  $H^p$  and the linear plane in  $\mathbb{R}^{d+1}$  spanned by  $\mathbf{0}$  and the line  $\ell^e$ . Then  $\zeta$  maps the point  $\mathbf{y}$  to the line  $p(\mathbf{y})$  in  $H_\infty^p$ , which is the asymptotic direction of all lines in  $H^p$  parallel to  $\ell^p$ . Irrespective of the line through  $\mathbf{y}$  and not contained in  $H^e \cap H_\infty^p$  that one chooses, we always obtain a line parallel to  $\ell^p$ , namely a line with asymptotic direction  $p(\mathbf{y})$ . It is customary to say that the map  $\zeta$  ‘sends every object in  $H^e \cap H_\infty^p$  to infinity’. See Fig. 2.5.1(b).

The map  $\zeta$  so defined is clearly projective: some intersecting lines are mapped onto parallel lines. As pointed out by Ziegler (1995, sec. 2.6), it is



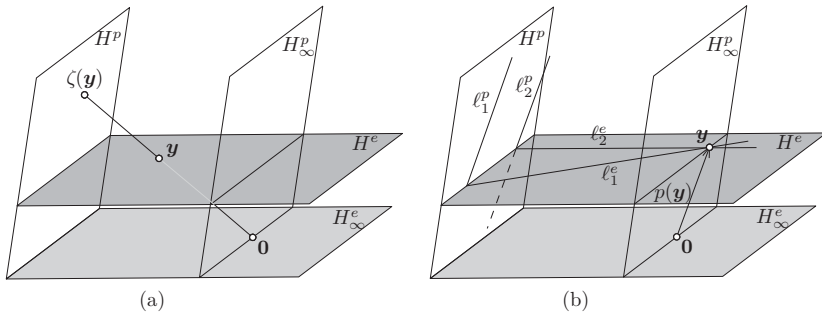

Figure 2.5.1 Mapping points in  $H^e$  onto  $H^p \cup H^p_\infty$ . (a) Mapping of a point in  $H^e \setminus (H^p \cup H^p_\infty)$ . (b) Mapping of a point in  $H^e \cap H^p_\infty$ .

hardly ever necessary to produce concrete formulas for the projective map. It suffices to understand how the map treats affine spaces, which is given in Proposition 2.5.2.

**Proposition 2.5.2** *Let  $\zeta : \mathbb{P}(\mathbb{R}^{d+1}) \rightarrow \mathbb{P}(\mathbb{R}^{d+1})$  be the projective map previously defined. Then  $\zeta$  takes an affine  $k$ -space  $A \not\subset H^e \cap H^p_\infty$  onto an affine  $k$ -space  $\zeta(A) \subseteq H^p$  and takes an affine  $k$ -space  $A \subset H^e \cap H^p_\infty$  onto a linear  $(k + 1)$ -space  $\zeta(A) \subset H^p_\infty$ .*

**Remark 2.5.3** Most of the time, everything boils down to recognising how the projective transformation treats lines and their intersections; this is summarised in (A)–(D) below, although it is an immediate corollary of Proposition 2.5.2. Figure 2.5.2 depicts the mapping of two lines in  $H^e$  onto  $H^p$ .

- (A) The map  $\zeta$  carries a line  $\ell^e$  in  $H^e$  into a line  $\ell^p$  in  $H^p$ , except those contain in  $H^e \cap H^p_\infty$ .
- (B) Let  $\ell_1^e$  and  $\ell_2^e$  be two lines of  $H^e$  that are not contained in  $H^e \cap H^p_\infty$  and intersect outside  $H^e \cap H^p_\infty$ . Then they are mapped onto intersecting lines  $\ell_1^p$  and  $\ell_2^p$  in  $H^p$ . If the lines  $\ell_1^e$  and  $\ell_2^e$  intersect in the positive open halfspace of  $H^p_\infty$ , then the lines  $\ell_1^p$  and  $\ell_2^p$  intersect in the positive open halfspace of  $H^e_\infty$  (Fig. 2.5.2(b)). If in turn the lines  $\ell_1^e$  and  $\ell_2^e$  intersect in the negative open halfspace of  $H^p_\infty$ , then the lines  $\ell_1^p$  and  $\ell_2^p$  intersect in the negative open halfspace of  $H^e_\infty$  (Fig. 2.5.2(d)).
- (C) Let  $\ell_1^e$  and  $\ell_2^e$  be two lines of  $H^e$  that are not contained in  $H^e \cap H^p_\infty$  but intersect inside  $H^e \cap H^p_\infty$ . Then they are mapped onto parallel lines  $\ell_1^p$  and  $\ell_2^p$  in  $H^p$  (Fig. 2.5.2(a)).
- (D) Let  $\ell_1^e$  and  $\ell_2^e$  be two parallel lines of  $H^e$  that are not contained in  $H^e \cap H^p_\infty$ . If they are not parallel to a line in  $H^e \cap H^p_\infty$ , then they are mapped onto lines  $\ell_1^p$  and  $\ell_2^p$  of  $H^p$  that intersect at  $H^p \cap H^e_\infty$ ; otherwise they are mapped onto lines parallel to a line in  $H^p \cap H^e_\infty$  (Fig. 2.5.2(c)).

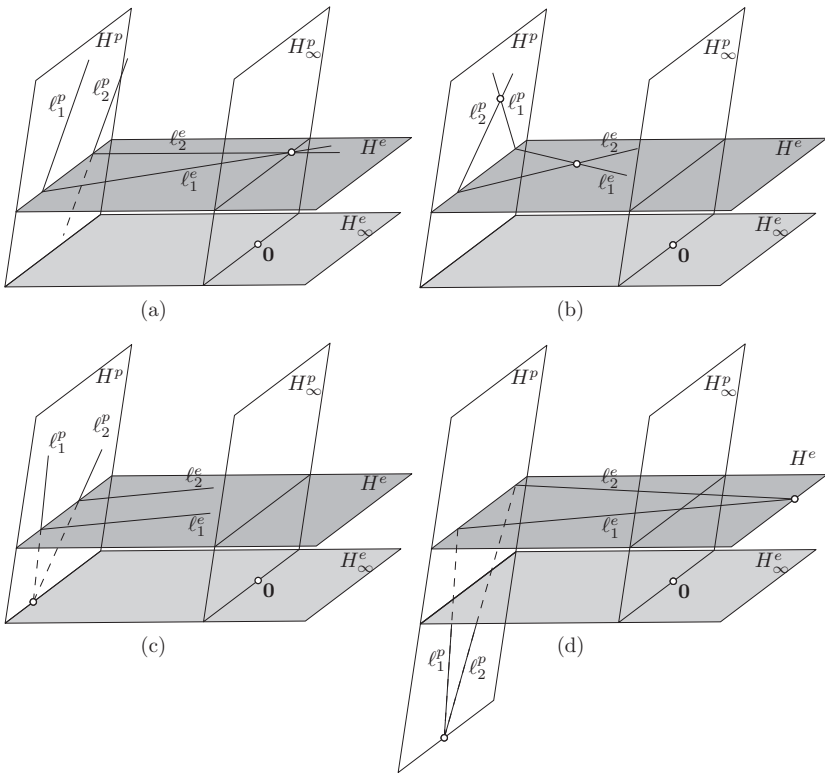

Figure 2.5.2 Mapping of two lines of  $H^e$  onto  $H^p$ . (a) The lines intersect at  $H^e \cap H^p_\infty$ . (b) The lines intersect inside the positive open halfspace defined by  $H^p_\infty$  and containing  $H^p$ . (c) The lines are parallel in  $H^e$ . (d) The lines intersect inside the negative open halfspace defined by  $H^p_\infty$  and not containing  $H^p$ .

## 2.6 Examples

This section examines particular examples of polytopes, with emphasis on their combinatorial properties.

### Simplices

The  $d$ -simplex, denoted  $T(d)$ , is the  $d$ -polytope with the smallest number of vertices. As we saw in Chapter 1, it is the convex hull of  $d + 1$  affinely independent points in  $\mathbb{R}^d$ . Figure 1.6.2 shows simplices in  $\mathbb{R}^3$ . For every  $k \in [0 \dots d]$ , the  $k$ -faces of a  $d$ -simplex are simplices of smaller dimension and every  $k + 1$  vertices yields a  $k$ -face. Thus the  $f$ -vector of  $T(d)$  can be easily computed.

**Proposition 2.6.1** *The number  $f_k$  of  $k$ -faces of a  $d$ -simplex  $T(d)$  is*

$$f_k(T(d)) = \binom{d+1}{k+1}, \text{ for every } k \in [-1 \dots d].$$

It is now obvious that all  $d$ -simplices are combinatorially isomorphic, and so we will talk of *the*  $d$ -simplex. The simplest realisation of  $T(d)$  is as the convex hull of the  $d + 1$  points of the standard basis of  $\mathbb{R}^{d+1}$ .

## Pyramids

The  $d$ -simplex  $T(d)$  can be also seen as the convex hull of a facet  $F$  of  $T(d)$  and the vertex in  $T(d) \setminus (\text{aff } F)$ . A pyramid generalises this construction.

A  $d$ -dimensional pyramid or  $d$ -pyramid in  $\mathbb{R}^d$  is the convex hull of a  $(d - 1)$ -polytope  $F$  and a point  $\mathbf{x} \in \mathbb{R}^d$  not on  $\text{aff } F$ ; it is denoted by  $\text{pyr } F$ . The polytope  $F$  is the *base* of the pyramid, while the point  $\mathbf{x}$  is the *apex* of the pyramid. We will often talk of this pyramid as being on or over  $F$ . A face  $I$  of  $\text{pyr } F$  either is a face of  $F$  or contains the apex  $\mathbf{x}$ . If  $\mathbf{x} \in I$  then  $\text{aff } F \cap I$  is a face  $J$  of  $F$  that contains the other vertices of  $I$ , and so  $I$  is a pyramid with base  $J$  and apex  $\mathbf{x}$ . The next proposition should now be clear.

**Proposition 2.6.2** *The number  $f_k$  of  $k$ -faces of a  $d$ -pyramid  $\text{pyr } F$  with base  $F$  is given by*

$$f_k(\text{pyr } F) = f_k(F) + f_{k-1}(F), \text{ for every } k \in [0 \dots d].$$

The pyramid construction can be generalised. Every  $d$ -polytope  $P$  is a 0-fold  $d$ -pyramid with  $P$  as base. And a 1-fold  $d$ -pyramid with base  $F$  is simply a  $d$ -pyramid over a  $(d - 1)$ -polytope  $F$ . If  $P$  is a pyramid over a base  $Q$  that is itself a  $(d - 1)$ -pyramid over a  $(d - 2)$ -polytope  $F$ , then we say that  $P$  is *two-fold  $d$ -pyramid* over the base  $F$ . In general, an  $r$ -fold  $d$ -pyramid  $P$  is a pyramid over a base  $Q$  that is itself an  $(r - 1)$ -fold  $(d - 1)$ -pyramid and the bases of  $P$  and  $Q$  coincide. In other words,  $P$  is an  $r$ -fold  $d$ -pyramid over a  $(d - r)$ -dimensional base  $F$  and is denoted by  $\text{pyr}_r F$ . An inductive application of Proposition 2.6.2 yields the number of faces of  $\text{pyr}_r F$ .

**Proposition 2.6.3** *The number  $f_k$  of  $k$ -faces of an  $r$ -fold  $d$ -pyramid  $\text{pyr}_r F$  with base  $F$  is given by*

$$f_k(\text{pyr}_r F) = \sum_{i=0}^r \binom{r}{i} f_{k-i}(F), \text{ for every } k \in [0 \dots d].$$

If the dimension of a  $d$ -pyramid or an  $r$ -fold  $d$ -pyramid is clear from the context or is nonessential, then we simply write pyramid or  $r$ -fold pyramid.

### Bipyramids

Let  $F$  be a  $(d - 1)$ -polytope in  $\mathbb{R}^d$  and let  $I = [x, y]$  be a line segment in  $\mathbb{R}^d$  such that  $\text{rint } I \cap \text{rint } F$  is a unique point. Then a  $d$ -bipyramid  $P$  in  $\mathbb{R}^d$  is the convex hull of  $F$  and  $I$ ; it is denoted by  $\text{bipyr } F$ . The polytope  $F$  is the *base* of the bipyramid, while the segment  $I$  is the *axis* of the bipyramid. We will often talk of a bipyramid *on* or *over*  $F$ . A face of  $\text{bipyr } F$  is either a proper face of  $F$ , a pyramid with a base in  $F$  and an apex in  $\{x, y\}$ , or a vertex in  $\{x, y\}$ . The next proposition should now be clear.

**Proposition 2.6.4** *The number  $f_k$  of  $k$ -faces of a  $d$ -bipyramid  $\text{bipyr } F$  with base  $F$  is given by*

$$f_k(\text{bipyr } F) = \begin{cases} f_k(F) + 2f_{k-1}(F), & \text{if } k \in [0 \dots d - 2]; \\ 2f_{d-2}(F), & \text{if } k = d - 1. \end{cases}$$

The definition of an  $r$ -fold  $d$ -bipyramid follows the same idea as that of an  $r$ -fold  $d$ -pyramid. Every  $d$ -polytope  $P$  is a 0-fold  $d$ -bipyramid with  $P$  as base. An  $r$ -fold  $d$ -bipyramid  $P$  is a bipyramid over a base  $Q$  that is itself an  $(r - 1)$ -fold  $(d - 1)$ -bipyramid, and the bases of  $P$  and  $Q$  coincide. In other words,  $P$  is an  $r$ -fold  $d$ -bipyramid over a  $(d - r)$ -dimensional base  $F$  and is denoted by  $\text{bipyr}_r F$ .

If the dimension of a  $d$ -bipyramid or an  $r$ -fold  $d$ -bipyramid is clear from the context or is nonessential, then we simply write bipyramid or  $r$ -fold bipyramid.

We met a  $(d - 1)$ -fold  $d$ -bipyramid in Chapter 1, the  $d$ -crosspolytope  $I(d)$ . In Chapter 1, the  $d$ -crosspolytope appeared as the dual of the  $d$ -cube. As a  $(d - 1)$ -fold  $d$ -bipyramid,  $I(d)$  can be realised as the convex hull of  $d$  segments that are pairwise orthogonal and have a common midpoint. It follows that  $I(d)$  is a bipyramid over  $I(d - 1)$ , wherefrom we get the number  $f_k$  of  $k$ -faces. Figure 2.6.1 shows crosspolytopes in  $\mathbb{R}^3$ .

**Proposition 2.6.5** *The number  $f_k$  of  $k$ -faces of a  $d$ -crosspolytope  $I(d)$  is given by*

$$f_k(I(d)) = 2^{k+1} \binom{d}{k+1}, \text{ for every } k \in [-1 \dots d - 1].$$

### Prisms

Let  $F$  be a  $(d - 1)$ -polytope in  $\mathbb{R}^d$  and let  $I = [\mathbf{0}, \mathbf{x}]$  be a line segment in  $\mathbb{R}^d$  such that  $\text{aff } I$  is not parallel to any line in  $\text{aff } F$ . Then the  $d$ -prism  $P$  with base  $F$  and axis  $I$ , denoted prism  $F$ , is the Minkowski sum  $F + I$ . This amounts to saying that prism  $F = \text{conv}(F \cup (F + \mathbf{x}))$ . A  $k$ -face of prism  $F$  is either a  $k$ -face of  $F$ , a  $k$ -face of  $F + \mathbf{x}$ , or the sum of  $I$  and some  $(k - 1)$ -face of  $F$ . The next proposition should now be clear.

**Proposition 2.6.6** *The number  $f_k$  of  $k$ -faces of a  $d$ -prism with base  $F$  is given by*

$$f_k(\text{prism } F) = \begin{cases} 2f_k(F), & \text{if } k = 0; \\ 2f_k(F) + f_{k-1}(F), & \text{if } k \in [1 \dots d]. \end{cases}$$

Continuing with the analogy to both pyramids and bipyramids, we define  $r$ -fold  $d$ -prisms. Every  $d$ -polytope  $P$  is a 0-fold  $d$ -prism with  $P$  as base. An  $r$ -fold  $d$ -prism  $P$  is a prism over a base  $Q$  that is itself an  $(r - 1)$ -fold  $(d - 1)$ -prism and the bases of  $P$  and  $Q$  coincide. In other words,  $P$  is an  $r$ -fold  $d$ -prism over a  $(d - r)$ -dimensional base  $F$  and is denoted by prism $_r F$ .

We have special names for some prisms. A  $d$ -prism with a simplex as a base is a *simplicial  $d$ -prism*. A  $(d - 1)$ -fold  $d$ -prism, which is also a  $d$ -fold  $d$ -prism, is a  *$d$ -parallelotope*; it is the sum of  $d$  segments with a common point such that no segment is in the affine hull of the others.

We met a  $d$ -parallelotope in Example 2.1.6, the  $d$ -cube  $Q(d)$ . There, we realised  $Q(d)$  as the convex hull of  $2^d$  vectors  $(\pm 1, \dots, \pm 1)^t$ . Here, we obtain  $Q(d)$  as the sum of  $d$  segments that are pairwise orthogonal and have equal length. It follows that  $Q(d)$  is a prism over  $Q(d - 1)$ , wherefrom we get the number  $f_k$  of  $k$ -faces. Figure 2.1.1 shows cubes in  $\mathbb{R}^3$ .

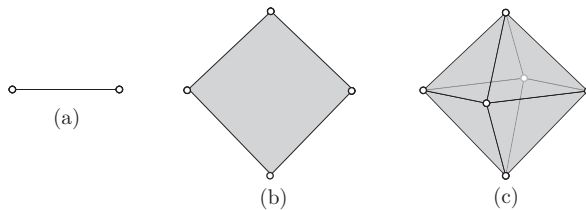

Figure 2.6.1 Crosspolytopes in  $\mathbb{R}^3$ . (a) A 1-crosspolytope. (b) A 2-crosspolytope. (c) A 3-crosspolytope, usually known as an octahedron.

**Proposition 2.6.7** *The number  $f_k$  of  $k$ -faces of a  $d$ -cube  $Q(d)$  is given by*

$$f_k(Q(d)) = 2^{d-k} \binom{d}{k}, \text{ for every } k \in [0 \dots d].$$

If the dimension of a  $d$ -prism or an  $r$ -fold  $d$ -prism is clear from the context or is nonessential, then we simply write prism or  $r$ -fold prism.

### Wedges

Let  $P$  be a  $d$ -polytope in  $\mathbb{R}^d$ . Embed  $P \times \{0\}$  in the hyperplane

$$H := \left\{ \begin{pmatrix} \mathbf{x} \\ x_{d+1} \end{pmatrix} \in \mathbb{R}^{d+1} \mid x_{d+1} = 0 \right\}$$

of  $\mathbb{R}^{d+1}$ , let  $F$  be a proper face of  $P$ , and let  $C$  be the halfcylinder  $P \times [0, \infty) \subset \mathbb{R}^{d+1}$ . We cut the halfcylinder with a hyperplane  $H'$  through  $F \times \{0\}$  so that  $C$  is partitioned into two parts, one bounded and one unbounded. The *wedge* of  $P$  at  $F$  is the bounded part; it is denoted by  $W_F(P)$ . The sets  $P$  and  $H' \cap C$  define facets of  $W_F(P)$  that are combinatorially isomorphic to  $P$  and intersect at the face  $F \times \{0\}$ ; the facets  $P$  and  $H' \cap C$  are the *bases* of  $W_F(P)$ . See an example in Fig. 2.6.2.

The wedge  $W$  over a  $d$ -polytope  $P \times \{0\} \subseteq \mathbb{R}^{d+1}$  at a face  $F \times \{0\}$  of  $P \times \{0\}$  is combinatorially isomorphic to a prism  $Q$  over  $P \times \{0\}$  where the face prism( $F \times \{0\}$ ) of  $Q$  has collapsed into  $F \times \{0\}$ . Some proper  $k$ -faces of  $W$  will be wedges defined as the wedge of a  $(k-1)$ -face  $J \times \{0\}$  of  $P \times \{0\}$  at a proper face  $(F \cap J) \times \{0\}$ . Some proper  $k$ -faces of  $W$  are  $k$ -prisms over  $(k-1)$ -faces of  $P \times \{0\}$  disjoint from  $F \times \{0\}$ ; these prisms are the *vertical faces* of  $W$ . These descriptions together with Proposition 2.6.6 give the following.

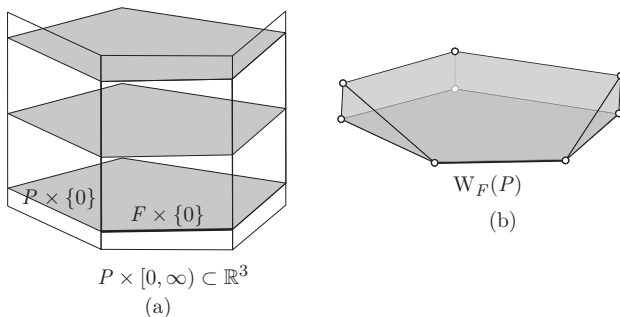

Figure 2.6.2 The wedge of the pentagon  $P$ . (a) The cylinder  $P \times \mathbb{R}$  in  $\mathbb{R}^3$ . (b) The wedge over  $P$  at a facet of  $P$ .

**Proposition 2.6.8** *Let  $P \subseteq \mathbb{R}^{d+1}$  be a  $d$ -polytope and  $F$  a proper face of  $P$ . A  $k$ -face of the wedge  $W$  of  $P$  at  $F$  is either a  $k$ -face of one of the bases of  $W$ , or the wedge of a  $(k - 1)$ -face  $J$  of  $P$  at the proper face  $F \cap J$ , or a vertical  $k$ -face.*

**Proposition 2.6.9** *The number  $f_k$  of  $k$ -faces of the wedge  $W$  of a  $d$ -polytope  $P$  at a facet  $F$  of  $P$  is given by*

$$f_k(W) = \begin{cases} 2f_k(P) - f_k(F), & \text{if } k = 0; \\ 2f_k(P) + f_{k-1}(P) - f_k(F) - f_{k-1}(F), & \text{if } k \in [1 \dots d + 1]. \end{cases}$$

### Dual Wedges

Let  $P$  be a  $d$ -polytope in  $\mathbb{R}^d$ . Embed  $P \times \{0\}$  in the hyperplane

$$H := \left\{ \begin{pmatrix} \mathbf{x} \\ x_{d+1} \end{pmatrix} \in \mathbb{R}^{d+1} \mid x_{d+1} = 0 \right\}$$

of  $\mathbb{R}^{d+1}$  and let  $\mathbf{v}$  be a vertex of  $P$ . The *dual wedge* of  $P$  at  $\mathbf{v}$ , denoted by  $dW_{\mathbf{v}}(P)$ , is the  $(d + 1)$ -polytope

$$dW_{\mathbf{v}}(P) := \text{conv}((P \times \{0\}) \cup (\mathbf{v} \times \{-1\}) \cup (\mathbf{v} \times \{1\})).$$

The facial structure of the dual wedge is plain from its description.

**Proposition 2.6.10** *Let  $P \times \{0\} \subseteq \mathbb{R}^{d+1}$  be a  $d$ -polytope and  $\mathbf{v}$  a vertex of  $P$ . A  $k$ -face of the dual wedge of  $P$  at  $\mathbf{v}$  is either a  $k$ -face of  $P$  not containing  $\mathbf{v}$ , or the dual wedge of a  $(k - 1)$ -face of  $P$  at  $\mathbf{v}$ , or a pyramid with apex  $\mathbf{v} \times \{-1\}$  or  $\mathbf{v} \times \{1\}$  over a  $(k - 1)$ -face of  $P$  not containing  $\mathbf{v}$ .*

As the name indicates, the dual wedge is in some sense the dual operation of a wedge: if we perform the wedge of a polytope  $P$  at a facet  $F$  of  $P$ , then we are performing the dual wedge of the dual polytope  $P^*$  at the conjugate vertex of  $F$  in  $P^*$  (Problem 2.15.11).

### Truncation of Faces

Let  $P$  be a  $d$ -polytope in  $\mathbb{R}^d$ , let  $F$  be a face of  $P$ , and let  $K$  be a closed halfspace in  $\mathbb{R}^d$  such that the vertices of  $P$  not in  $K$  are the vertices of  $F$ . A polytope  $P'$  is obtained by *truncating the face  $F$*  of  $P$  if  $P' = P \cap K$ . The polytope  $P'$  retains all the old facets of  $P$ , except  $F$  if it was a facet, and gains a new facet.

Truncating faces is a flexible operation. We can see that a simplicial  $d$ -prism is obtained from a  $d$ -simplex  $T$  by truncating a vertex of  $T$ .

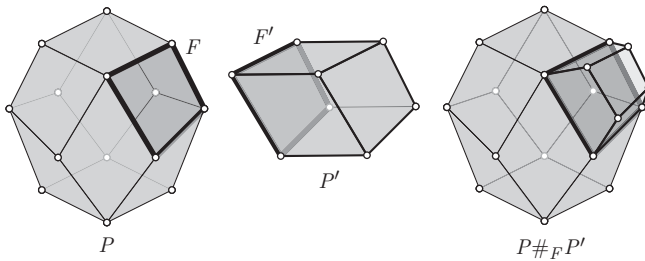

Figure 2.6.3 Connected sum of two polytopes.

### Connected Sums

Two polytopes  $P$  and  $P'$  are *projectively isomorphic* if there is a projective isomorphism  $\zeta$  permissible for  $P$  such that  $\zeta(P) = P'$ .

Let  $P$  and  $P'$  be two  $d$ -polytopes with a facet  $F$  of  $P$  projectively isomorphic to a facet  $F'$  of  $P'$ . The *connected sum*  $P\#_F P'$  of  $P$  and  $P'$  is obtained by ‘gluing’  $P$  and  $P'$  along  $F$  and  $F'$ ; if the facet  $F$  is of no importance, we simply write  $P\#P'$ . Projective transformations on the polytopes  $P$  and  $P'$  may be required for the connected sum to be convex. A common method is first to assume that  $P$  and  $P'$  are realised so that  $P \cap P' = F = F'$ , and then to apply a projective transformation  $\zeta$  to  $P'$  so that  $\zeta$  fixes  $F'$  and  $\text{conv}(P \cup \zeta(P'))$  becomes a realisation of  $P\#_F P'$ ; Problem 2.15.7 asks for the details of this transformation. The connected sum of two polytopes is depicted in Fig. 2.6.3. The faces of  $P\#_F P'$  are described next.

**Proposition 2.6.11** *Let  $P$  and  $P'$  be two  $d$ -polytopes with a facet  $F$  of  $P$  projectively isomorphic to a facet  $F'$  of  $P'$ . Then the proper faces of  $P\#_F P'$  consist of all the proper faces of  $P$  and  $P'$ , except for the facets  $F$  and  $F'$ .*

The connected sum of a  $d$ -simplex and a  $d$ -polytope with a simplex facet is called *stacking*; this sum is always possible (Problem 2.15.9). The *stacked polytopes* are the polytopes obtained from a simplex by successive stacking. The dual operation of stacking is truncating a vertex: if we stack over a facet  $F$  of a polytope  $P$ , then the conjugate vertex of  $F$  in the dual  $P^*$  of  $P$  gets truncated (Problem 2.15.10). In particular, the dual of a stacked polytope is a *truncated polytope*, a polytope obtained from a simplex by repeatedly truncating vertices.



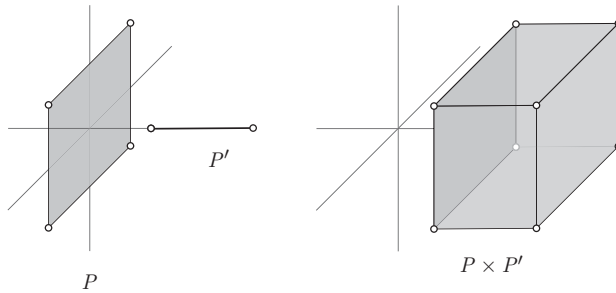

Figure 2.6.4 Cartesian products of two polytopes. The Cartesian product of the 2-cube  $P := \text{conv}\{(-1, -1)^t, (1, -1)^t, (-1, 1)^t, (1, 1)^t\}$  and the segment  $P' := \text{conv}\{(1), (2)\}$ .

### Cartesian Products

The *Cartesian product*  $P \times P'$  of a  $d$ -polytope  $P \subset \mathbb{R}^d$  and a  $d'$ -polytope  $P' \subset \mathbb{R}^{d'}$  is the Cartesian product of the sets  $P$  and  $P'$ :

$$P \times P' = \left\{ \begin{pmatrix} \mathbf{p} \\ \mathbf{p}' \end{pmatrix} \in \mathbb{R}^{d+d'} \mid \mathbf{p} \in P, \mathbf{p}' \in P' \right\}. \quad (2.6.12)$$

The resulting polytope is  $(d + d')$ -dimensional. An example is depicted in Fig. 2.6.4.

The characterisation of the faces of a Cartesian product is presented in Proposition 2.6.13.

**Proposition 2.6.13** *Let  $P \subset \mathbb{R}^d$  be a  $d$ -polytope and  $P' \subset \mathbb{R}^{d'}$  a  $d'$ -polytope. The  $k$ -faces of the Cartesian product  $P \times P'$  are precisely the Cartesian products of an  $i$ -face  $F$  of  $P$  and a  $j$ -face  $F'$  of  $P'$  such that  $i + j = k$ , for each  $k \in [0 \dots d + d']$ .*

### Free Joins

Let  $P \subset \mathbb{R}^{d+d'+1}$  be a  $d$ -polytope and  $P' \subset \mathbb{R}^{d+d'+1}$  a  $d'$ -polytope such that their affine hulls are skew; two affine spaces are *skew* if they do not intersect and no line from one space is parallel to a line from the other. The *free join*  $P * P'$  of the polytopes  $P$  and  $P'$  is the  $(d + d' + 1)$ -polytope  $\text{conv}(P \cup P')$ . For a concrete setting, let  $P$  be a  $d$ -polytope and  $P'$  a  $d'$ -polytope both of which are embedded in  $\mathbb{R}^{d+d'+1}$  as follows:

$$P = \text{conv} \left\{ \left( \begin{array}{c} \mathbf{p} \\ \mathbf{0}_{d'} \\ 0 \end{array} \right) \in \mathbb{R}^{d+d'+1} \mid \mathbf{p} \in P \right\},$$

$$P' = \text{conv} \left\{ \left( \begin{array}{c} \mathbf{0}_d \\ \mathbf{p}' \\ 1 \end{array} \right) \in \mathbb{R}^{d+d'+1} \mid \mathbf{p}' \in P' \right\}.$$

Then

$$P * P' = \text{conv} \left( \left\{ \left( \begin{array}{c} \mathbf{p} \\ \mathbf{0}_{d'} \\ 0 \end{array} \right) \in \mathbb{R}^{d+d'+1} \mid \mathbf{p} \in P \right\} \cup \left\{ \left( \begin{array}{c} \mathbf{0}_d \\ \mathbf{p}' \\ 1 \end{array} \right) \in \mathbb{R}^{d+d'+1} \mid \mathbf{p}' \in P' \right\} \right). \tag{2.6.14}$$

A pyramid over a  $d$ -polytope  $P$  with apex  $\mathbf{x}$  is the free join of  $P$  and the point  $\mathbf{x}$ ; in this case, we write  $P * \mathbf{x}$  rather than  $P * \{\mathbf{x}\}$ .

The characterisation of the faces of a free join is presented in Proposition 2.6.15.

**Proposition 2.6.15** *Let  $P \subset \mathbb{R}^{d+d'+1}$  be a  $d$ -polytope and  $P' \subset \mathbb{R}^{d+d'+1}$  a  $d'$ -polytope such that  $\text{aff } P$  and  $\text{aff } P'$  are skew. The  $k$ -faces of the free join  $P * P'$  are precisely the free joins of an  $i$ -face  $F$  of  $P$  and a  $j$ -face  $F'$  of  $P'$  such that  $i + j + 1 = k$ , for  $k \in [0 \dots d + d']$ .*

A consequence of Proposition 2.6.15 is a formula for the number of faces of a free join.

**Corollary 2.6.16** *Let  $P \subset \mathbb{R}^{d+d'+1}$  be a  $d$ -polytope and  $P' \subset \mathbb{R}^{d+d'+1}$  a  $d'$ -polytope such that  $\text{aff } P$  and  $\text{aff } P'$  are skew. The number  $f_k$  of  $k$ -faces of  $P * P'$  is given by*

$$f_k(P * P') = \sum_{i=-1}^k f_i(P) f_{k-i-1}(P'), \text{ for every } k \in [0 \dots d + d'].$$

### Direct Sums

The *direct sum*  $P \oplus P'$  of a  $d$ -polytope  $P \subset \mathbb{R}^d$  and a  $d'$ -polytope  $P' \subset \mathbb{R}^{d'}$  with the origin in their relative interiors is the  $(d + d')$ -polytope

$$P \oplus P' = \text{conv} \left( \left\{ \left( \begin{array}{c} \mathbf{p} \\ \mathbf{0}_{d'} \end{array} \right) \in \mathbb{R}^{d+d'} \mid \mathbf{p} \in P \right\} \cup \left\{ \left( \begin{array}{c} \mathbf{0}_d \\ \mathbf{p}' \end{array} \right) \in \mathbb{R}^{d+d'} \mid \mathbf{p}' \in P' \right\} \right). \tag{2.6.17}$$

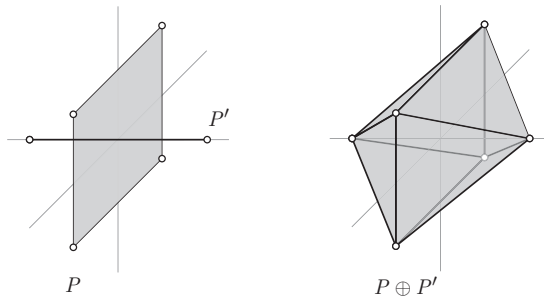

Figure 2.6.5 Direct sum of two polytopes. The direct sum of the 2-cube  $P := \text{conv}\{(-1, -1)^t, (1, -1)^t, (-1, 1)^t, (1, 1)^t\}$  and the segment  $P' := \text{conv}\{(-1), (1)\}$ .

The resulting polytope lies in  $\mathbb{R}^{d+d'}$  and has  $f_0(P) + f_0(P')$  vertices and  $f_{d-1}(P) \times f_{d'-1}(P')$  facets. An example is depicted in Fig. 2.6.5.

From the definition, it is clear that the direct sum  $P \oplus P'$  is a projection of the join  $P * P'$ . It is not so clear but true that the direct sum  $P \oplus P'$  is closely related to the Cartesian product  $P \times P'$  by duality.

**Proposition 2.6.18** *If  $P \subset \mathbb{R}^d$  is a  $d$ -polytope and  $P' \subset \mathbb{R}^{d'}$  is a  $d'$ -polytope such that the origin is in their relative interiors, then*

$$P \oplus P' = (P^* \times (P')^*)^*.$$

### 2.7 Face Figures

Face figures of a  $d$ -polytope  $P$  are polytopes whose face lattices are formed by the set of faces  $F$  between some  $i$ -face  $F_i$  and some  $j$ -face  $F_j$  of  $P$  such that  $F_i \subseteq F \subseteq F_j$ , for  $-1 \leq i < j \leq d$ . The most useful of the face figures is the vertex figure, the case when  $i = 0$  and  $j = d$ , and as such, vertex figures are the focus of this section.

Vertex figures exist around each of the vertices of a polytope; they contain information on the facial structure of the polytope and the dual polytope. Let  $P$  be a  $d$ -polytope in  $\mathbb{R}^d$ , let  $v$  be a vertex of  $P$ , and let  $H$  be a hyperplane in  $\mathbb{R}^d$  that has  $v$  on one side of  $H$  and the remaining vertices of  $P$  on the other side. The *vertex figure*  $P/v$  of  $P$  at  $v$  is the set  $P \cap H$ ; see Fig. 2.7.1.

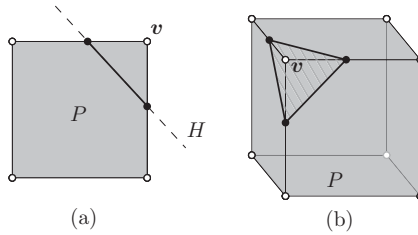

Figure 2.7.1 Vertex figures of polytopes. (a) A segment as the vertex figure of a 2-polytope. (b) A triangle as the vertex figure of a 3-polytope.

**Theorem 2.7.1**<sup>4</sup> *Let  $P$  be a  $d$ -polytope in  $\mathbb{R}^d$  and let  $H$  be a hyperplane in  $\mathbb{R}^d$  such that  $H$  intersects the interior of  $P$ . Then the following hold:*

- (i) *The polytope  $P' := P \cap H$  is  $(d - 1)$ -dimensional.*
- (ii) *If  $F$  is a  $k$ -face of  $P$ , then the set  $F' := F \cap H$  is a  $k'$ -face of  $P'$  with  $k' \leq k$ ; in the case of  $F$  and  $F'$  being proper faces and  $H$  not being a supporting hyperplane of  $F$  at  $F'$ , we have that  $k' = k - 1$ .*
- (iii) *If  $F'$  is a  $k'$ -face of  $P'$  but not of  $P$ , then there is a unique  $k$ -face  $F$  of  $P$  such that  $F' = H \cap F$  and  $k' = k - 1$ .*

While many choices are possible for a hyperplane that defines a vertex figure  $Q$  of a polytope, all of them produce the same face lattice of  $Q$ . In other words, the combinatorics of  $Q$  is independent of the hyperplane.

**Theorem 2.7.2** *Let  $P$  be a  $d$ -polytope and let  $v$  be a vertex of  $P$ . Suppose that  $H$  is a hyperplane in  $\mathbb{R}^d$  such that  $H \cap P$  is the vertex figure  $P/v$  of  $P$  at  $v$ . Then there is a bijection  $\sigma$  from the  $k$ -faces  $F$  of  $P$  that contain  $v$  to the  $(k - 1)$ -faces  $F'$  of  $P/v$ , given by*

$$\begin{aligned} \sigma(F) &= H \cap F =: F', \\ \sigma^{-1}(F') &= \text{aff}(\{v\} \cup F') =: F. \end{aligned}$$

*Proof* The hyperplane  $H$  intersects  $\text{int } P$ , and so Theorem 2.7.1(i) implies that  $P/v$  is a  $(d - 1)$ -polytope. If  $F$  is a  $k$ -face of  $P$  that contains  $v$ , then  $H$  does not support  $F$ , which implies that  $F' := F \cap H$  is a  $k'$ -face of  $P/v$  of dimension  $\dim F - 1$  (Theorem 2.7.1(ii)). Moreover, for each  $k'$ -face  $F'$  of  $P/v$ , we have that  $F'$  is not a face of  $P$ . Therefore, Theorem 2.7.1(iii) gives the existence of a unique  $k$ -face  $F$  of  $P$  that contains  $v$  and satisfies  $k' = k - 1$ . It is now clear that  $\sigma$  is a bijection (by Theorem 2.7.1). □

<sup>4</sup> A proof is available in Brøndsted (1983, thm. 11.1).

There is a close link between the vertex figure of a polytope  $P$  at a vertex  $v \in P$  and the facet of the dual polytope  $P^*$  that is conjugate to  $v$ .

**Theorem 2.7.3** *Let  $P$  and  $P^*$  be dual polytopes and let  $\psi$  be an antiisomorphism from  $\mathcal{L}(P)$  to  $\mathcal{L}(P^*)$ . Suppose that  $v$  is a vertex of  $P$  and that  $P/v$  is the vertex figure of  $P$  at  $v$ . Then the facet  $\psi(v)$  of  $P^*$  is a dual of  $P/v$ .*

*Proof* This is a consequence of Theorem 2.7.2 and the fact that  $\mathcal{L}(P)$  is the opposite of  $\mathcal{L}(P^*)$  (Corollary 2.4.11).

From Theorem 2.7.2, it follows that the face lattice  $\mathcal{L}(P/v)$  of  $P/v$  is isomorphic to the sublattice  $\mathcal{L}_v$  of  $\mathcal{L}(P)$  formed by the faces of  $P$  containing  $v$ . And, since  $\mathcal{L}(P)$  is the opposite of  $\mathcal{L}(P^*)$ ,  $\mathcal{L}_v$  is antiisomorphic to the sublattice  $\mathcal{L}(\psi(v))$  of  $\mathcal{L}(P^*)$  corresponding to the facet  $\psi(v)$  of  $P^*$ . Hence  $\mathcal{L}(P/v)$  is antiisomorphic to  $\mathcal{L}(\psi(v))$ , as desired.  $\square$

Face figures generalise vertex figures; they can be obtained as an iterated vertex figure. Let  $P$  be a  $d$ -polytope,  $F_i$  an  $i$ -face of  $P$ , and  $F_j$  a  $j$ -face of  $P$  such that  $-1 \leq i < j \leq d$ . The set of faces  $F$  of  $P$  such that  $F_i \subseteq F \subseteq F_j$  is a *face figure*  $F_j/F_i$  of  $P$ . The vertex figure  $P/v$  of  $P$  at a vertex  $v$  is recovered when  $F_i = v$  and  $F_j = P$ . It is useful to consider  $F_j$  as a  $j$ -polytope and  $F_i$  as a face of  $F_j$ , as we will see in Chapter 8. In this way, we can extend Theorem 2.7.3 to all face figures. If we consider  $F_j$  and its dual polytope  $F_j^*$  as  $j$ -polytopes and let  $\psi_j$  be an antiisomorphism from  $\mathcal{L}(F_j)$  to  $\mathcal{L}(F_j^*)$ , then the face figure  $F_j/F_i$  is combinatorially isomorphic to the dual of the face  $\psi_j(F_i)$  in  $F_j^*$ .

**Theorem 2.7.4**<sup>5</sup> *Let  $P$  be a  $d$ -polytope,  $F_i$  an  $i$ -face of  $P$ , and  $F_j$  a  $j$ -face of  $P$  such that  $-1 \leq i < j \leq d$ . Then the face figure  $F_j/F_i$  is combinatorially isomorphic to a  $(j - 1 - i)$ -polytope  $Q$ . Additionally, to each face  $F$  of  $P$  such that  $F_i \subseteq F \subseteq F_j$  there corresponds a face in  $Q$  of dimension  $\dim(F) - 1 - i$ .*

This is a good place to introduce some graph-theoretical terminology in order to streamline our future statements. For an edge  $e = \text{conv}\{\mathbf{x}, \mathbf{y}\}$  of a polytope  $P$ , we write  $e = [\mathbf{x}, \mathbf{y}]$  or  $e = \mathbf{x}\mathbf{y}$ , and we say that the vertices  $\mathbf{x}$  and  $\mathbf{y}$  are *adjacent* or *neighbours*, and that the edge  $e$  is *incident* with  $\mathbf{x}$  and  $\mathbf{y}$ . We denote the set of neighbours of a vertex  $\mathbf{x}$  in  $P$  by  $\mathcal{N}_P(\mathbf{x})$ :

$$\mathcal{N}_P(\mathbf{x}) = \{\mathbf{y} \in \mathcal{V}(P) \mid \mathbf{x}\mathbf{y} \in \mathcal{E}(P)\}; \tag{2.7.5}$$

we often drop the symbol  $P$  if the reference is clear from the context.

<sup>5</sup> A proof is available in Brøndsted (1983, thm. 11.4).

In a polytope, issuing a ray from each edge containing a given vertex produces a cone that contains the polytope.

**Theorem 2.7.6** *Let  $P$  be a polytope in  $\mathbb{R}^d$  and let  $\mathbf{v} \in \mathcal{V}(P)$ . Then the affine convex cone based at  $\mathbf{v}$  and spanned by the neighbours of  $\mathbf{v}$  in  $P$  contains  $P$ . Notationally,*

$$P \subseteq \mathbf{v} + \text{cone} \{ \mathbf{u} - \mathbf{v} \mid \mathbf{u} \in \mathcal{N}_P(\mathbf{v}) \}.$$

*Proof* Let  $H$  be a hyperplane in  $\mathbb{R}^d$  such that  $P \cap H$  defines the vertex figure  $P/\mathbf{v}$  of  $P$  at  $\mathbf{v}$ . Take any other vertex  $\mathbf{y}$  of  $P$ . Then the segment  $[\mathbf{v}, \mathbf{y}]$  intersects  $H$  at a point  $\mathbf{y}'$ , a point of  $P/\mathbf{v}$ . It follows that  $\mathbf{y}$  lies in the ray  $\{ \mathbf{v} + \alpha(\mathbf{y}' - \mathbf{v}) \mid \alpha \geq 0 \}$ , which in turn implies that

$$P \subseteq \{ \mathbf{v} + \alpha(\mathbf{y}' - \mathbf{v}) \mid \text{for all } \mathbf{y}' \in P/\mathbf{v}, \alpha \geq 0 \}. \tag{2.7.6.1}$$

Every point  $\mathbf{y}' \in P/\mathbf{v}$  is in the convex hull of  $\mathcal{V}(P/\mathbf{v})$  and so

$$\begin{aligned} & \{ \mathbf{v} + \alpha(\mathbf{y}' - \mathbf{v}) \mid \text{for all } \mathbf{y}' \in P/\mathbf{v}, \alpha \geq 0 \} \\ & \subseteq \mathbf{v} + \text{cone} \{ \mathbf{w} - \mathbf{v} \mid \text{for all } \mathbf{w} \in \mathcal{V}(P/\mathbf{v}) \}. \end{aligned} \tag{2.7.6.2}$$

Additionally, every vertex of  $P/\mathbf{v}$  lies in a ray from  $\mathbf{v}$  to a neighbour of  $\mathbf{v}$ . Thus

$$\mathbf{v} + \text{cone} \{ \mathbf{w} - \mathbf{v} \mid \text{for all } \mathbf{w} \in \mathcal{V}(P/\mathbf{v}) \} \subseteq \mathbf{v} + \text{cone} \{ \mathbf{u} - \mathbf{v} \mid \mathbf{u} \in \mathcal{N}_P(\mathbf{v}) \}. \tag{2.7.6.3}$$

Combining (2.7.6.1), (2.7.6.2), and (2.7.6.3), we get that

$$P \subseteq \mathbf{v} + \text{cone} \{ \mathbf{u} - \mathbf{v} \mid \mathbf{u} \in \mathcal{N}_P(\mathbf{v}) \},$$

the desired conclusion. □

An immediate corollary of Theorem 2.7.6 is the following.

**Corollary 2.7.7** *Let  $P$  be a  $d$ -polytope in  $\mathbb{R}^d$  and let  $\mathbf{v} \in \mathcal{V}(P)$ . Then*

$$\text{aff}(\{ \mathbf{v} \} \cup \mathcal{N}_P(\mathbf{v})) = \mathbb{R}^d.$$

*Proof* If the the statement were false, then the set  $\{ \mathbf{v} \} \cup \mathcal{N}(\mathbf{v})$  would lie in a hyperplane  $H$  in  $\mathbb{R}^d$ . This would in turn imply that the affine convex cone  $C := \mathbf{v} + \text{cone} \{ \mathbf{u} - \mathbf{v} \mid \mathbf{u} \in \mathcal{N}(\mathbf{v}) \}$  is in  $H$ . However,  $P \subset C$  (Theorem 2.7.6), which would lead to the contradictory conclusion that a  $d$ -polytope lies in  $H$ . Hence the corollary follows. □

Another corollary of Theorem 2.7.6 is the following.

**Corollary 2.7.8** *Let  $P$  be a  $d$ -polytope in  $\mathbb{R}^d$  and let  $\mathbf{v} \in \mathcal{V}(P)$ . Suppose that  $H$  is a hyperplane in  $\mathbb{R}^d$  and  $K$  is a closed halfspace defined by  $H$ . If  $H$  contains  $\mathbf{v}$  and  $K$  contains  $\mathcal{N}_P(\mathbf{v})$ , then  $K$  is a supporting halfspace of  $P$ ; that is,  $P \subseteq K$ .*

*Proof* The vertices  $\{\mathbf{v}\} \cup \mathcal{N}(\mathbf{v})$  of  $P$  all lie in  $K$ , and so  $K$ , being an affine convex cone itself, contains the affine convex cone  $C := \mathbf{v} + \text{cone}\{\mathbf{u} - \mathbf{v} \mid \mathbf{u} \in \mathcal{N}(\mathbf{v})\}$ . By Theorem 2.7.6,  $P \subseteq C$ . Hence  $P \subseteq K$ .  $\square$

## 2.8 Simple and Simplicial Polytopes

A polytope is *simplicial* if every facet is a simplex. And a  $d$ -polytope is *simple* if every vertex is contained in precisely  $d$  facets; otherwise the  $d$ -polytope is *nonsimple*. It is clear that a simplex is a simple polytope. A face of a polytope that is itself a simple polytope is a *simple face*; otherwise the face is *nonsimple*. Trivially, every vertex, edge, and 2-polytope is simple. Simplicial and simple polytopes are closely related by duality.

**Theorem 2.8.1** *A polytope is simple if and only if its dual polytope is simplicial.*

*Proof* Let  $P$  be a  $d$ -polytope,  $P^*$  the dual polytope of  $P$ , and  $\psi$  an antiisomorphism from  $\mathcal{L}(P)$  to  $\mathcal{L}(P^*)$ . Suppose that  $P$  is simple. Then every vertex  $\mathbf{v}$  of  $P$  is contained in precisely  $d$  facets. Since  $\mathcal{L}(P)$  is the opposite of  $\mathcal{L}(P^*)$ , the facet  $\psi(\mathbf{v})$  of  $P^*$  that is conjugate to  $\mathbf{v}$  contains precisely  $d$  vertices; that is,  $\psi(\mathbf{v})$  is a simplex (Problem 2.15.5). Every facet of  $P^*$  is the conjugate of some vertex of  $P$ ; hence  $P^*$  is simplicial.

Suppose that  $P^*$  is simplicial. Then every facet  $F$  of  $P^*$  is a simplex; it has precisely  $d$  vertices. Because  $\mathcal{L}(P^*)$  is the opposite of  $\mathcal{L}(P)$ , the vertex  $\psi^{-1}(F)$  of  $P$  is contained in precisely  $d$  facets. Additionally, every vertex of  $P$  is the conjugate of some facet of  $P^*$ . Hence  $P$  is simple.  $\square$

In the same way that we gave special names to the 0-faces, 1-faces, and  $(d-1)$ -faces of a  $d$ -polytope  $P$ , we give the name *ridge* to a  $(d-2)$ -face of  $P$ .

We define simple polytopes by the number of facets in which each vertex is contained. An alternative definition could have considered the number of edges.

**Theorem 2.8.2** *A  $d$ -polytope is simple if and only if each vertex is incident with precisely  $d$  edges.*

*Proof* Let  $P$  be a  $d$ -polytope,  $P^*$  the dual polytope of  $P$ , and  $\psi$  an antiisomorphism from  $\mathcal{L}(P)$  to  $\mathcal{L}(P^*)$ . A vertex  $v$  of  $P$  is contained in precisely  $d$  edges if and only if the  $(d - 1)$ -face  $\psi(v)$  of  $P^*$  contains precisely  $d$  ridges of  $P^*$ . And a  $(d - 1)$ -face has precisely  $d$  ridges of  $P^*$  if and only if it is a  $(d - 1)$ -simplex (Problem 2.15.5). Thus, every vertex of  $P$  is incident with precisely  $d$  edges if and only if  $P^*$  is simplicial, and thus the result now follows from Theorem 2.8.1.  $\square$

A  $d$ -polytope  $P$  is  $k$ -simplicial if each  $k$ -face of  $P$  is a simplex; every polytope is 1-simplicial and simplicial polytopes are  $(d - 1)$ -simplicial. The polytope  $P$  is said to be  $k$ -simple if each  $(d - 1 - k)$ -face is contained in precisely  $k + 1$  facets; every polytope is 1-simple and simple polytopes are  $(d - 1)$ -simple. Theorem 2.8.1 ensures that a polytope  $P$  is simple if and only if  $P^*$  is simplicial. This generalises to  $k$ -simplicial and  $k$ -simple polytopes:  $P$  is  $k$ -simplicial if and only if  $P^*$  is  $k$ -simple (Problem 2.15.8).

According to Theorem 2.4.16, a  $k$ -face  $F$  of a  $d$ -polytope is contained in at least  $d - k$  facets of the polytope. This lower bound is met with equality in the case of simple polytopes.

**Theorem 2.8.3** *Let  $P$  be a simple  $d$ -polytope,  $k$  a number in  $[0 \dots d - 1]$ , and  $F_1, \dots, F_{d-k}$  facets of  $P$ . Then*

$$F := \bigcap_{i=1}^{d-k} F_i$$

*is either  $\emptyset$  or a  $k$ -face of  $P$ .*

*Proof* Let  $P^*$  be the dual polytope of  $P$ , and let  $\psi$  be an antiisomorphism from  $\mathcal{L}(P)$  to  $\mathcal{L}(P^*)$ . If  $F = \emptyset$  there is nothing to prove, so suppose otherwise. The face  $F$  is the largest face of  $P$  contained in the facets  $F_1, \dots, F_{d-k}$ , and so the face  $\psi(F)$  is the smallest face of  $P^*$  containing the vertices  $\psi(F_1), \dots, \psi(F_{d-k})$ . Since  $P^*$  is simplicial, each facet of  $P^*$  is a simplex (Theorem 2.8.1), which implies that every face of  $P^*$  is simplex. Thus  $\psi(F)$  is a  $(d - k - 1)$ -simplex. Theorem 2.4.12 now ensures that  $F$  is a  $k$ -face of  $P$ .  $\square$

Theorem 2.8.3 gives that a  $j$ -face of a simple  $d$ -polytope is contained in exactly  $d - j$  facets. We can give the exact number of  $k$ -faces containing the  $j$ -face.

**Theorem 2.8.4** *Let  $P$  be a simple  $d$ -polytope and let  $0 \leq j \leq k \leq d$ . Then there are precisely*

$$\binom{d - j}{d - k}$$



*k*-faces of *P* containing a given *j*-face of *P*.

*Proof* Let *J* be a *j*-face of *P*. If *k* = *d* then *P* is the only *d*-face containing *J*. Let *P*\* be the dual polytope of *P* and let  $\psi$  be an antiisomorphism from  $\mathcal{L}(P)$  to  $\mathcal{L}(P^*)$ . If instead *k* < *d*, then  $\psi(J)$  is a (*d* − 1 − *j*)-face of *P*\* and the number of *k*-faces of *P* containing *J* coincides with the number of (*d* − 1 − *k*)-faces of  $\psi(J)$ . Since  $\psi(J)$  is a (*d* − 1 − *j*)-simplex, it contains

$$\binom{d - j}{d - k}$$

(*d* − 1 − *k*)-faces by Proposition 2.6.1. The proof is now complete. □

The application of duality in the proof of Theorem 2.8.4 also gives that each vertex of a *k*-face *F* in a simple polytope is contained in precisely *k* (*k* − 1)-faces of *F*, which ensures that *F* is also a simple polytope (by definition).

**Theorem 2.8.5** *Every proper face of a simple polytope is another simple polytope.*

Another important property of simple polytopes is that every *k*-subset of edges incident with a vertex defines a *k*-face. It is easy to find examples of polytopes that do not satisfy the latter property. For instance, consider a 3-crosspolytope *I* as a bipyramid over a quadrangle *Q*. Then no two edges of *Q* sharing a vertex define a 2-face of *I*.

**Theorem 2.8.6** *Let *P* be a simple *d*-polytope and *k* ∈ [0 . . . *d* − 1]. Suppose that *v* is a vertex of *P*, *vv*<sub>1</sub>, . . . , *vv*<sub>*k*</sub> are *k* edges of *P* that are incident with *v*, and *F* is the smallest face of *P* containing these edges. Then *F* is a simple *k*-face of *P*.*

*Proof* Let *P*\* be the dual polytope of *P* and let  $\psi$  be an antiisomorphism from  $\mathcal{L}(P)$  to  $\mathcal{L}(P^*)$ . By duality, the face  $\psi(F)$  is the largest face of *P*\* contained in the (*d* − 2)-faces  $\psi(vv_1), \dots, \psi(vv_k)$  of the facet  $\psi(v)$ :

$$\psi(F) = \bigcap_{i=1}^k \psi(vv_i).$$

The facet  $\psi(v)$  is a simplex (by Theorem 2.7.3 or Theorem 2.8.1). From Theorem 2.8.3, it follows that  $\psi(F)$  is a (*d* − 1 − *k*)-face of  $\psi(v)$ . Since  $\psi(F)$  is contained in precisely *k* (*d* − 2)-faces of  $\psi(v)$ , the *k* edges *vv*<sub>1</sub>, . . . , *vv*<sub>*k*</sub> are the only edges of *P* that are incident with *v* and are contained in *F*.

The face *F* is the conjugate of  $\psi(F)$ , and so it is a *k*-face of *P*. Thus, by Theorem 2.8.5 it is a simple polytope. □

The proof of Theorem 2.8.6 also yields a slightly more general result.

**Theorem 2.8.7** *Let  $P$  be a  $d$ -polytope and  $k \in [0 \dots d - 1]$ . Suppose that  $\mathbf{v}$  is a vertex of  $P$  incident with precisely  $d$  edges in  $P$ . Further suppose that  $\mathbf{v}\mathbf{v}_1, \dots, \mathbf{v}\mathbf{v}_k$  are  $k$  edges of  $P$  that are incident with  $\mathbf{v}$  and that  $F$  is the smallest face of  $P$  containing these edges. Then  $F$  is a  $k$ -face of  $P$  and these  $k$  edges are the only edges of  $F$  incident with  $\mathbf{v}$ .*

By Theorem 2.8.7, vertices in a  $d$ -polytope  $P$  that are incident with precisely  $d$  edges behave as vertices of a simple  $d$ -polytope. In view of this, we will say that such a vertex is *simple*; a vertex in  $P$  incident with more than  $d$  edges is *nonsimple*. Since every vertex is a simple 0-polytope, the expressions ‘simple vertex’ and ‘nonsimple vertex’ will refer only to the nature of the vertex in relation to the ambient polytope, and they should cause no confusion.

A  $d$ -simplex is both simple and simplicial, which characterises  $d$ -simplices for  $d \geq 3$ .

**Theorem 2.8.8** *A simple and simplicial polytope is a simplex or a 2-polytope.*

*Proof* The case of two dimensions is trivial, so let  $P$  be a  $d$ -polytope that is both simple and simplicial for  $d \geq 3$ . Take a vertex  $\mathbf{v}_0$  of  $P$ . Since  $P$  is simple, the vertex  $\mathbf{v}_0$  is incident with precisely  $d$  edges  $\mathbf{v}_0\mathbf{v}_1, \dots, \mathbf{v}_0\mathbf{v}_d$  (Theorem 2.8.2). Let  $X := \{\mathbf{v}_0, \mathbf{v}_1, \dots, \mathbf{v}_d\}$  and let  $T := \text{conv } X$ . Because  $P$  is simplicial, every  $d - 1$  of these edges defines a simplex facet of  $P$  (Theorem 2.8.6). It follows that, for  $d \geq 3$ , every pair of vertices in  $X$  are adjacent in  $P$ . As a result, every vertex  $\mathbf{v}_i$  in  $X$  is adjacent to precisely  $d$  other vertices in  $X$ . Hence  $T \subseteq P$ .

Consider any supporting halfspace  $K$  of  $T$  and let  $H$  be a hyperplane bounding  $K$ . Then  $T \cap H$  is a proper face of  $T$  and thus it contains a vertex  $\mathbf{v}_\ell$  with  $\ell \in [0 \dots d]$ . Since  $H$  contains  $\mathbf{v}_\ell$  and  $K$  contains all the neighbours of  $\mathbf{v}_\ell$  in  $P$ , Corollary 2.7.8 ensures that  $K$  is a supporting halfspace of  $P$ . In other words, every supporting halfspace of  $T$  is a supporting halfspace of  $P$ . A polytope is the intersection of its supporting halfspaces (Theorem 1.8.3). Hence  $P \subseteq T$ , concluding that  $P = T$ .  $\square$

Similarly, for  $d \geq 3$ ,  $d$ -cubes are the only simple and cubical polytopes. A polytope is *cubical* if every facet is a cube. A proof for this result follows from Blind and Blind (1998, sec. 7).

**Theorem 2.8.9** (Blind and Blind, 1998) *A simple and cubical polytope is a cube or a 2-polytope.*

### 2.9 Cyclic and Neighbourly Polytopes

Cyclic polytopes are the  $d$ -polytopes with the maximum number of  $k$ -faces among the  $d$ -polytope with  $n$  vertices, for each  $k \in [0 \dots d - 1]$  (Chapter 8). Because of this, they feature in a number of fundamental results in polytope theory, in particular in the upper bound theorem of McMullen (1970). This section studies them.

The moment curve  $\mu_d$  in  $\mathbb{R}^d$  is defined, for  $x \in [a, b]$ , as

$$\mu_d(x) = (x, x^2, \dots, x^d)^t. \tag{2.9.1}$$

We next describe some of the properties of the moment curve.

**Proposition 2.9.2** (Properties of the moment curve) *The moment curve  $\mu_d$  in  $\mathbb{R}^d$  has the following properties:*

- (i) *Every  $d + 1$  points on  $\mu_d$  are affinely independent.*
- (ii) *If  $d$  distinct points on  $\mu_d$  lie in a hyperplane  $H$  of  $\mathbb{R}^d$ , then the curve at each intersection with  $H$  passes from one side of  $H$  to the other side.*

*Proof* Let  $H$  be a hyperplane in  $\mathbb{R}^d$  defined as

$$H := \left\{ \mathbf{y} \in \mathbb{R}^d \mid \mathbf{y} \cdot (a_1, \dots, a_d)^t = -a_0 \right\}.$$

Then, for some  $i \in [0 \dots d]$ , we have  $a_i \neq 0$ . With the numbers  $a_0, \dots, a_d$ , we now define a nonzero polynomial  $p_H(x)$  of degree at most  $d$ :

$$p_H(x) = a_0 + a_1x + \dots + a_dx^d.$$

It follows that a point  $\mu_d(x_i)$  is in  $H$  if and only if  $x_i$  is a root of  $p_H$ . The polynomial  $p_H$  has at most  $d$  roots, and so no  $d + 1$  points on  $\mu_d$  can lie in  $H$ ; this shows (i). Suppose that  $H$  contains exactly  $d$  distinct points of  $\mu_d$ . Then  $p_H$  has  $d$  simple roots. In a small neighbourhood of a simple root, the polynomial is either increasing or decreasing, which causes the moment curve to pass from one side of  $H$  to the other side; this proves (ii) □

A cyclic  $d$ -polytope  $C(n, d)$  is the convex hull of  $n \geq d + 1$  points  $\mu_d(x_1), \dots, \mu_d(x_n)$  on the moment curve satisfying  $x_1 < \dots < x_n$ . Properties of cyclic polytopes are explained from properties of the moment curve.

**Proposition 2.9.3** *Let  $P$  be a cyclic  $d$ -polytope on  $n$  vertices. Then*

- (i)  *$P$  is simplicial; and*
- (ii) *every set of  $k$  vertices of  $P$ , with  $2k \leq d$ , forms a  $(k - 1)$ -face.*

*Proof* (i) This ensues from Proposition 2.9.2(i).

(ii) Let  $P$  be the convex hull of the  $n$  points  $\mu_d(x_1), \dots, \mu_d(x_n)$  with  $x_1 < \dots < x_n$ . Set  $X := \{x_1, \dots, x_n\}$ . Among the elements of  $X$ , select a  $k$ -subset  $X_k$  satisfying  $x'_1 < \dots < x'_k$ . With these  $k$  numbers, we define a polynomial

$$p_k(x) := (x - x'_1)^2 \cdots (x - x'_k)^2 = a_0 + a_1x + \cdots + a_{2k}x^{2k}$$

of degree  $2k \leq d$ . And with the coefficients  $a_0, \dots, a_{2k}$ , we define a hyperplane  $H_k$  in  $\mathbb{R}^d$

$$H_k := \left\{ \mathbf{y} \in \mathbb{R}^d \mid \mathbf{y} \cdot (a_1, \dots, a_{2k}, 0, \dots, 0)^t = -a_0 \right\}.$$

It follows that all the points  $\mu_d(x'_i)$  with  $x'_i \in X_k$  are in  $H_k$ , and that any other point  $\mu_d(x_j)$  with  $x_j \in X \setminus X_k$  lies in the same side of  $H_k$ , as the expression

$$\begin{aligned} \mu_d(x_j) \cdot (a_1, \dots, a_{2k}, 0, \dots, 0)^t &= -a_0 + p_k(x_j) \\ &= -a_0 + (x_j - x'_1)^2 \cdots (x_j - x'_k)^2 \\ &> -a_0 \end{aligned}$$

attests. Hence  $H_k$  supports  $P$  at  $\text{conv} \{ \mu_d(x'_1), \dots, \mu_d(x'_k) \}$ , which is a  $(k-1)$ -simplex by (i). This proves (ii). □

Gale (1963) provided a criterion to tell which  $d$ -subsets of vertices of a cyclic  $d$ -polytope form a facet. The criterion relies on a linear ordering  $\leq$  on the vertices  $\mu_d(x_1), \dots, \mu_d(x_n)$  of a cyclic  $d$ -polytope  $P$  given by  $\mu_d(x_i) \leq \mu_d(x_j)$  if and only if  $x_i \leq x_j$ . Henceforth, we implicitly assume that a cyclic polytope is coupled with this vertex ordering.

**Theorem 2.9.4** (Gale’s evenness condition) *Let  $P$  be a cyclic  $d$ -polytope. A  $d$ -subset  $X$  of  $\mathcal{V}(P)$  is the vertex set of a facet of  $P$  if and only if, for every two distinct vertices in  $\mathcal{V}(P) \setminus X$ , the number of elements of  $X$  between them is even.*

We put Gale’s evenness condition into practice.

**Example 2.9.5** Consider a cyclic 3-polytope  $P$  on seven vertices and the following sets:

$$\begin{aligned} X_1 &:= \{ \mu_3(4), \mu_3(5), \mu_3(6) \}, \\ X_2 &:= \{ \mu_3(3), \mu_3(4), \mu_3(6) \}, \\ X_3 &:= \{ \mu_3(1), \mu_3(3), \mu_3(4) \}. \end{aligned}$$

See Fig. 2.9.1. Between any two vertices  $\mu_3(x_i)$  and  $\mu_3(x_j)$  of  $P$  outside  $X_1$ , there are zero elements of  $X_1$ , since  $x_i, x_j \in [0 \dots 3]$ ; here, we use the linear ordering of the vertices of  $P$ . Thus  $X_1$  is the vertex set of a facet of  $P$ .

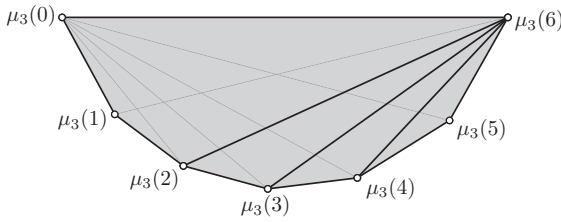

Figure 2.9.1 A cyclic 3-polytope on seven vertices.

Take any two vertices  $\mu_3(x_i)$  and  $\mu_3(x_j)$  of  $P \setminus X_2$ . If  $x_i, x_j \in [0 \dots 2]$ , then there are zero elements of  $X_2$  between  $\mu_3(x_i)$  and  $\mu_3(x_j)$ . So suppose  $x_j = 5$ . Then  $x_i \in [0 \dots 2]$ , and the vertices  $\mu_3(3)$  and  $\mu_3(4)$  of  $X_2$  are between  $\mu_3(x_i)$  and  $\mu_3(x_j)$ . Hence  $X_2$  is also the vertex set of a facet of  $P$ .

Take the vertices  $\mu_3(0)$  and  $\mu_3(2)$  of  $P \setminus X_3$ . Between  $\mu_3(0)$  and  $\mu_3(2)$ , there is exactly one vertex of  $X_3$ , namely  $\mu_3(1)$ . Hence  $X_3$  is not the vertex set of a facet of  $P$ .

*Proof of Gale’s evenness condition (Theorem 2.9.4)* Let  $H$  be a hyperplane in  $\mathbb{R}^d$  that is spanned by  $X$ . The set  $X$  determines a facet of  $P$  if and only if all the vertices in  $\mathcal{V}(P) \setminus X$  lie in the same side of  $H$ . Take any two distinct vertices  $\mu_d(x_i), \mu_d(x_j) \in \mathcal{V}(P) \setminus X$  with  $x_i < x_j$ . The moment curve at each intersection with  $H$  passes from one side of  $H$  to the other side (Proposition 2.9.2(ii)). Therefore,  $\mu_d(x_i)$  and  $\mu_d(x_j)$  lie in the same side of  $H$  if and only if, while traversing the curve from  $\mu_d(x_i)$  to  $\mu_d(x_j)$ , we encounter an even number of vertices of  $X$ . □

One consequence of Gale’s evenness condition is that every cyclic  $d$ -polytope on  $n$  vertices has the same facet-vertex incidence matrix (Section 2.3). Thus, every two cyclic  $d$ -polytopes on  $n$  vertices are combinatorially isomorphic, and we can just talk of the cyclic  $d$ -polytope on  $n$  vertices, namely  $C(n, d)$ .

A second consequence of Gale’s evenness condition is that we can talk of linear orderings of vertices of  $C(n, d)$  satisfying the condition. We say that a linear ordering

$$u_1 <' \dots <' u_n$$

of the vertices of  $C(n, d)$  is *cyclic* if it satisfies Gale’s evenness condition: a  $d$ -subset  $X$  of  $\mathcal{V}(C(n, d)) \setminus X$  determines a facet of  $C(n, d)$  if and only if, between any two vertices of  $\mathcal{V}(C(n, d)) \setminus X$ , there is an even number of elements of  $X$  in the vertex ordering  $<'$ . The aforementioned linear ordering  $<$  of the vertices of  $C(n, d)$  given by

$$\mu_d(x_1) < \dots < \mu_d(x_n) \text{ whenever } x_1 < \dots < x_n$$

is cyclic. The following two assertions are now plain.

**Proposition 2.9.6** *A simplicial  $d$ -polytope  $P$  is combinatorially isomorphic to  $C(n, d)$  if and only if some ordering*

$$\mathbf{u}_1 < \dots < \mathbf{u}_n$$

*of the vertices of  $P$  is cyclic.*

**Lemma 2.9.7** *Let  $d$  be even. If the ordering  $\mathbf{u}_1 < \dots < \mathbf{u}_n$  of the vertices of  $C(n, d)$  is cyclic, then so is the ordering*

$$\mathbf{u}_i < \dots < \mathbf{u}_n < \mathbf{u}_1 < \dots < \mathbf{u}_{i-1},$$

*for each  $i \in [1 \dots n]$ .*

Gale’s evenness condition explains the vertex figures of cyclic polytopes.

**Theorem 2.9.8** (Vertex figures of cyclic polytopes) *Let  $P$  be a cyclic  $d$ -polytope with a vertex ordering  $\mathbf{u}_1 < \dots < \mathbf{u}_n$  that satisfies Gale’s evenness condition (2.9.4). Then the following holds:*

- (i) *For odd  $d$ , every facet of  $P$  contains  $\mathbf{u}_1$  or  $\mathbf{u}_n$ .*
- (ii) *For even  $d$ , the vertex figure of  $P$  at every vertex is a cyclic  $(d - 1)$ -polytope.*
- (iii) *For odd  $d$ , the vertex figures  $P/\mathbf{u}_1$  and  $P/\mathbf{u}_n$  of  $P$  at vertices  $\mathbf{u}_1$  and  $\mathbf{u}_n$ , respectively, are cyclic  $(d - 1)$ -polytopes.*
- (iv) *If all the vertex figures of  $P$  are cyclic  $(d - 1)$ -polytopes on  $n - 1$  vertices then*

$$df_{d-1}(P) = nf_{d-2}(C(n - 1, d - 1)).$$

- (v) *For odd  $d \geq 5$ , we have that*

$$f_{d-1}(P) = 2f_{d-2}(C(n - 1, d - 1)) - f_{d-3}(C(n - 2, d - 2)).$$

- (vi) *For  $n \geq d + 2$  and odd  $d \geq 5$ , the vertex figure  $P/\mathbf{u}_i$  of  $P$  at some other vertex  $\mathbf{u}_i$  is not a cyclic  $(d - 1)$ -polytope.*
- (vii) *For odd  $d \geq 3$ ,  $P$  is the dual wedge of  $C(n - 1, d - 1)$  at any vertex.*

*Proof* (i) If a facet of  $P$  did not contain  $\mathbf{u}_1$  or  $\mathbf{u}_n$ , then there would be an odd number of vertices between  $\mathbf{u}_1$  and  $\mathbf{u}_n$ , which would violate Gale’s evenness condition.

(ii) This is true for  $d = 2$  so assume that  $d \geq 4$ . Let  $\mathbf{u}_i$  be a vertex of  $P$  and  $X$  a  $(d - 1)$ -subset of  $\mathcal{V}(P) \setminus \{\mathbf{u}_i\}$ . Because  $P$  is simplicial and the  $(k - 1)$ -faces

of  $P/\mathbf{u}_i$  are in one-to-one correspondence with the  $k$ -faces of  $P$  containing  $\mathbf{u}_i$  (Theorem 2.7.2), we have the following.

**Claim 1** The proper faces of  $P/\mathbf{u}_i$  can be thought of as faces of  $P$ . In particular, the subset  $X$  of  $\mathcal{V}(P)$  is the vertex set of a  $(d - 2)$ -face of  $P/\mathbf{u}_i$  if and only if the  $d$ -subset  $X \cup \{\mathbf{u}_i\}$  of  $\mathcal{V}(P)$  is the vertex set of a  $(d - 1)$ -face  $F$  of  $P$ .

Since the graph of  $P$  is a complete graph (Proposition 2.9.3), this claim implies the next assertion.

**Claim 2** The polytope  $P/\mathbf{u}_i$  is a simplicial  $(d - 1)$ -polytope with vertex set  $\mathcal{V}(P) \setminus \{\mathbf{u}_i\}$ .

According to Lemma 2.9.7, the ordering

$$\mathbf{u}_i < \mathbf{u}_{i+1} < \cdots < \mathbf{u}_n < \mathbf{u}_1 < \cdots < \mathbf{u}_{i-1} \tag{2.9.8.1}$$

is cyclic. If  $X \cup \{\mathbf{u}_i\}$  is the vertex set of a  $(d - 1)$ -face of  $P$ , then Gale’s evenness condition on  $P$  yields an even number of elements from  $X \cup \{\mathbf{u}_i\}$  between any two vertices  $\mathbf{y}$  and  $\mathbf{z}$  in  $\mathcal{V}(P) \setminus (X \cup \{\mathbf{u}_i\})$ , with respect to the ordering (2.9.8.1). As a consequence, there is an even number of vertices from  $X$  between the same two vertices  $\mathbf{y}$  and  $\mathbf{z}$  in  $\mathcal{V}(P) \setminus (X \cup \{\mathbf{u}_i\})$ , with respect to the ordering

$$\mathbf{u}_{i+1} < \cdots < \mathbf{u}_n < \mathbf{u}_1 < \cdots < \mathbf{u}_{i-1} \tag{2.9.8.2}$$

of the vertices of  $P/\mathbf{u}_i$  (Claims 1 and 2). This shows that the ordering (2.9.8.2) is cyclic, implying that  $P/\mathbf{u}_i$  is combinatorially isomorphic to a cyclic  $(d - 1)$ -polytope on  $n - 1$  vertices (Proposition 2.9.6).

(iii) The reasoning is similar to that of (ii). According to (i), every facet of  $P$  contains  $\mathbf{u}_1$  or  $\mathbf{u}_n$ . If  $X \cup \{\mathbf{u}_1\}$  is the vertex set of a  $(d - 1)$ -face of  $P$ , then, by Gale’s evenness condition on  $P$ , there is an even number of elements from  $X \cup \{\mathbf{u}_1\}$  between any two vertices  $\mathbf{y}$  and  $\mathbf{z}$  in  $\mathcal{V}(P) \setminus (X \cup \{\mathbf{u}_1\})$ , with respect to the the ordering  $\mathbf{u}_1 < \cdots < \mathbf{u}_n$ . As in (ii), it follows that there is an even number of vertices from  $X$  between the same two vertices  $\mathbf{y}$  and  $\mathbf{z}$  in  $\mathcal{V}(P) \setminus (X \cup \{\mathbf{u}_1\})$ , with respect to the ordering

$$\mathbf{u}_2 < \cdots < \mathbf{u}_n$$

of the vertices of  $P/\mathbf{u}_1$  (see Claim 1 from the proof of (ii)). This shows that this ordering is cyclic, implying that  $P/\mathbf{u}_1$  is combinatorially isomorphic to a cyclic  $(d - 1)$ -polytope on  $n - 1$  vertices (Proposition 2.9.6). The same analysis yields that  $P/\mathbf{u}_n$  is combinatorially isomorphic to a cyclic  $(d - 1)$ -polytope on  $n - 1$  vertices.

(iv) We count the facet–vertex incidences of  $P$  in two different ways. A vertex  $\mathbf{u}$  of  $P$  is contained in  $f_{d-2}(P/\mathbf{u})$  facets of  $P$ , which is equal to  $f_{d-2}(C(n-1, d-1))$  by assumption. Additionally, a facet contains  $d$  vertices and  $P$  has  $f_{d-1}(P)$  facets. The result is now clear.

(v) Because of (iii), the vertex figures  $P/\mathbf{u}_1$  and  $P/\mathbf{u}_n$  are cyclic  $(d-1)$ -polytopes on  $n-1$  vertices, and so there are  $f_{d-2}(C(n-1, d-1))$  facets of  $P$  containing  $\mathbf{u}_1$  and  $f_{d-2}(C(n-1, d-1))$  facets of  $P$  containing  $\mathbf{u}_n$ . Furthermore, the number of facets of  $P$  containing both  $\mathbf{u}_1$  and  $\mathbf{u}_n$  coincides with the number of ways of selecting  $d-2$  vertices from  $\{\mathbf{u}_2, \dots, \mathbf{u}_{n-1}\}$  such that the ordering  $\mathbf{u}_2 < \dots < \mathbf{u}_{n-1}$  is cyclic; this is the same as counting the number  $f_{d-3}(C(n-2, d-2))$  of  $(d-3)$ -faces of a cyclic  $(d-2)$ -polytope on  $n-2$  vertices. The formula now follows.

(vi) Suppose, by way of contradiction, that the vertex figure  $P/\mathbf{u}$  of  $P$  at every vertex  $\mathbf{u}$  is a cyclic  $(d-1)$ -polytope on  $n-1$  vertices. In this case, an application of (iv) to  $P$  yields that

$$df_{d-1}(P) = nf_{d-2}(C(n-1, d-1)). \tag{2.9.8.3}$$

Moreover, as  $d-1 \geq 4$  is even, Part (ii) gives that all vertex figures of  $P/\mathbf{u}$  are cyclic  $(d-2)$ -polytopes on  $n-2$  vertices. Another application of (iv) to  $P/\mathbf{u}$  gives that

$$(d-1)f_{d-2}(C(n-1, d-1)) = (n-1)f_{d-3}(C(n-2, d-2)). \tag{2.9.8.4}$$

We solve (2.9.8.3) for  $f_{d-1}(P)$  and (2.9.8.4) for  $f_{d-3}(C(n-2, d-2))$ , and then we put these expressions for  $f_{d-1}(P)$  and  $f_{d-3}(C(n-2, d-2))$  into (v) to obtain that

$$\begin{aligned} \frac{n}{d}f_{d-2}(C(n-1, d-1)) &= 2f_{d-2}(C(n-1, d-1)) \\ &\quad - \frac{d-1}{n-1}f_{d-2}(C(n-1, d-1)), \end{aligned}$$

or equivalently that

$$f_{d-2}(C(n-1, d-1)) \left( \frac{n}{d} - 2 + \frac{d-1}{n-1} \right) = 0.$$

Solving this equation amounts to solving

$$\frac{n}{d} - 2 + \frac{d-1}{n-1} = 0,$$

which reduces to  $(d-n)(1+d-n) = 0$ . The solutions are  $n = d$  or  $n = d+1$ , violating our assumption of  $n \geq d+2$ .

(vii) This can be verified from Gale’s evenness condition (2.9.4) on  $P$ , and so it is left to the reader. □



### Cyclic Polytopes and Curves of Order $d$

Our initial, and the standard, presentation of cyclic polytopes uses the moment curve to realise the polytopes and unveil their properties. However, other curves could have been chosen instead, although none would beat the simplicity of the moment curve.

Denote by  $\mathcal{C}[a, b]$  the space of continuous, real-valued functions defined on the interval  $[a, b]$ . This is a linear space over  $\mathbb{R}$  with norm

$$\|\varphi\| := \max_{x \in [a, b]} |\varphi(x)|. \tag{2.9.9}$$

The moment curve is defined with the set  $\{\varphi_1(x) = x, \dots, \varphi_d(x) = x^d\}$  of functions from  $\mathcal{C}[a, b]$ . It turns out that polytopes combinatorially isomorphic to cyclic polytopes can be realised with sets of functions from  $\mathcal{C}[a, b]$  that satisfy Haar’s condition on  $[a, b]$  (Timan, 1963, sec. 2.3).

**Definition 2.9.10** (Haar’s condition) A curve  $\omega_d: \mathbb{R} \rightarrow \mathbb{R}^d$  defined by

$$\omega_d(x) := (\varphi_1(x), \dots, \varphi_d(x))^t \tag{2.9.10.1}$$

satisfies *Haar’s condition* if each  $\varphi_i \in \mathcal{C}[a, b]$ , and for every  $d + 1$  distinct numbers  $x_1, \dots, x_{d+1}$  in  $[a, b]$  satisfying  $x_1 < \dots < x_{d+1}$ , the points  $\omega_d(x_1), \dots, \omega_d(x_{d+1})$  are affinely independent in  $\mathbb{R}^d$ .

A curve  $\omega_d: \mathbb{R} \rightarrow \mathbb{R}^d$  satisfying Haar’s condition is said to be a *curve of order  $d$* . Let  $\omega_d: \mathbb{R} \rightarrow \mathbb{R}^d$  be a curve of order  $d$  defined as

$$\omega_d(x) = (\varphi_1(x), \dots, \varphi_d(x))^t.$$

We define a  $d$ -polytope  $C'(n, d)$  as the convex hull of  $n \geq d + 1$  points

$$\begin{aligned} \omega_d(x_1) &= (\varphi_1(x_1), \dots, \varphi_d(x_1))^t, \\ &\vdots \\ \omega_d(x_n) &= (\varphi_1(x_n), \dots, \varphi_d(x_n))^t, \end{aligned}$$

where  $x_1, \dots, x_n \in [a, b]$  and  $x_1 < \dots < x_n$ .

A proof similar to that of Gale’s evenness condition (Theorem 2.9.4) applies to the polytope  $C'(n, d)$ . As a result, the polytope  $C'(n, d)$  has the same facet–vertex incidence matrix as the cyclic polytope  $C(n, d)$ , and so both polytopes are combinatorially isomorphic.

A result of Sturmfels (1987) states that, for every cyclic- $d$ -polytope  $P$  of even dimension  $d$ , there exists a curve  $\omega_d(x)$  of order  $d$  such that  $P = \text{conv} \{\omega_d(x_1), \dots, \omega_d(x_n)\}$ , for numbers  $x_1 < \dots < x_n$  in  $[a, b]$ . The situation

is different for odd dimension  $d \geq 3$ : there are cyclic  $d$ -polytopes on  $n \geq d+3$  vertices that do not arise from curves of order  $d$  (Cordovil and Duchet, 2000).

### Neighbourly Polytopes

One of the most appealing properties of cyclic polytopes is that they are very ‘neighbourly’: every set of  $k$  vertices,  $k \leq \lfloor d/2 \rfloor$ , forms a  $(k-1)$ -face (Proposition 2.9.3(ii)). We have met this notion before. In the context of graphs, a complete graph is as ‘neighbourly’ as possible: every two vertices form an edge. Likewise, in the realm of polytopes, a  $d$ -simplex is as ‘neighbourly’ as possible: every  $k$  vertices form a proper  $(k-1)$ -face, for each  $k \leq d$ . In this final part, we explore the concept of ‘neighbourliness’.

We say that a  $d$ -polytope  $P$  is  $k$ -neighbourly if every set of at most  $k$  vertices is the vertex set of a proper face of  $P$ . Proposition 2.9.3(ii) states that cyclic  $d$ -polytopes are  $\lfloor d/2 \rfloor$ -neighbourly. We will see that, apart from the  $d$ -simplex, no other  $d$ -polytope is  $k$ -neighbourly for  $k > \lfloor d/2 \rfloor$ , and so  $\lfloor d/2 \rfloor$ -neighbourly  $d$ -polytopes on  $n$  vertices such as  $C(n, d)$  are the second best ‘neighbourly’  $d$ -polytopes, and they exist for every  $n \geq d+1$  (Proposition 2.9.3(ii)). For this reason, we call a  $\lfloor d/2 \rfloor$ -neighbourly  $d$ -polytope simply a *neighbourly  $d$ -polytope*; equivalently, we may say that a neighbourly  $d$ -polytope is a  $d$ -polytope with the  $(\lfloor d/2 \rfloor - 1)$ -skeleton of some  $n$ -simplex for  $n \geq d+1$ . Proposition 2.9.11 gathers the main properties of  $k$ -neighbourly polytopes.

**Proposition 2.9.11**<sup>6</sup> *Let  $P$  be a  $k$ -neighbourly  $d$ -polytope. Then*

- (i) *every  $k$  vertices of  $P$  are affinely independent;*
- (ii)  *$k \leq d$ ;*
- (iii)  *$P$  is  $k'$ -neighbourly, for each  $k' \in [1..k]$ ;*
- (iv) *if  $k > \lfloor d/2 \rfloor$  then  $P$  is a  $d$ -simplex; and*
- (v) *if  $k = \lfloor d/2 \rfloor$  then  $P$  is  $(d-2)$ -simplicial, and if in addition  $d$  is even, then  $P$  is simplicial.*

## 2.10 Inductive Constructions of Polytopes

This section focusses on an inductive construction of the convex hull of a polytope, one in which a vertex is added at each stage. This is the so-called *beneath-beyond algorithm* of Grünbaum (1963) and Grünbaum (2003, sec. 5.2).

<sup>6</sup> A proof is available in Grünbaum (2003, sec. 7.1).

Let  $P$  be a  $d$ -polytope in  $\mathbb{R}^d$  and let  $\mathbf{x}$  be a point in  $\mathbb{R}^d$ . We say that a facet  $F$  of  $P$  is *visible* from the point  $\mathbf{x}$  with respect to a polytope  $P$  in  $\mathbb{R}^d$  if  $\mathbf{x}$  belongs to the open halfspace determined by  $\text{aff } F$  that is disjoint from  $P$  (Fig. 2.10.1(a)). If instead  $\mathbf{x}$  belongs to the open halfspace that contains the interior of  $P$ , we say that the facet  $F$  is *nonvisible* from  $\mathbf{x}$  (Fig. 2.10.1(a)). Similarly, a hyperplane  $H$ , disjoint from the interior of  $P$ , is either *visible* or *nonvisible* from the point  $\mathbf{x}$ , with respect to  $P$ , depending on whether  $\mathbf{x}$  lies in the open halfspace determined by  $H$  that is disjoint from  $P$  or in the open halfspace of  $H$  that contains the interior of  $P$ . Moreover, the point  $\mathbf{x}$  is *beyond* a face  $J$  of  $P$  if the facets of  $P$  containing  $J$  are precisely those that are visible from  $\mathbf{x}$  and the facets of  $P$  not containing  $J$  are all nonvisible from  $\mathbf{x}$ .

Our terminology follows that of Ziegler (1995, sec. 8.2), and it differs from that of Grünbaum (2003, sec. 5.2) in that the definitions of ‘visible’ and ‘nonvisible’ coincide with those of ‘beyond’ and ‘beneath’ in Grünbaum (2003, sec. 5.2), respectively. In addition, a facet  $F$  is visible or nonvisible from a point  $\mathbf{x}$  in our sense if and only if  $\mathbf{x}$  is beyond or beneath  $\text{aff } F$ , respectively, in Grünbaum’s sense.

**Theorem 2.10.1** (Construction of polytopes; Grünbaum [1963]) *Let  $P$  and  $P'$  be two  $d$ -polytopes in  $\mathbb{R}^d$  and let  $\mathbf{v}'$  be a vertex of  $P'$  such that  $\mathbf{v}' \notin P$  and  $P' = \text{conv}(P \cup \{\mathbf{v}'\})$ . Then the following hold:*

- (i) *A face  $F$  of  $P$  is a face of  $P'$  if and only if there exists a facet of  $P$  containing  $F$  that is nonvisible from  $\mathbf{v}'$  with respect to  $P$ .*
- (ii) *If  $F$  is a face of  $P$  with  $\mathbf{v}' \in \text{aff } F$ , then  $F' := \text{conv}(F \cup \{\mathbf{v}'\})$  is a face of  $P'$ .*
- (iii) *If  $F$  is a face of  $P$  such that, among the facets of  $P$  containing  $F$ , there is at least one that is visible from  $\mathbf{v}'$  (with respect to  $P$ ) and at least one that is nonvisible (with respect to  $P$ ), then*

$$F' := \text{conv}(F \cup \{\mathbf{v}'\})$$

*is a face of  $P'$ .*

- (iv) *For each face  $F'$  of  $P'$ , there is a face  $F$  of  $P$  for which (i), (ii), or (iii) applies. In other words, each face of  $P'$  falls precisely in one of the above cases.*

*Proof* The main observation here is that every face of  $P'$  is either a face of  $P$  or the convex hull of  $\mathbf{v}'$  and some face of  $P$ , because a hyperplane supporting  $P'$  at a face of  $P'$  other than  $\mathbf{v}'$  also supports  $P$ .

- (i) A facet  $J$  of  $P$  with supporting hyperplane  $H$  is a facet of  $P'$  with the same supporting hyperplane  $H$  if and only if  $J$  is nonvisible from  $\mathbf{v}'$  (with

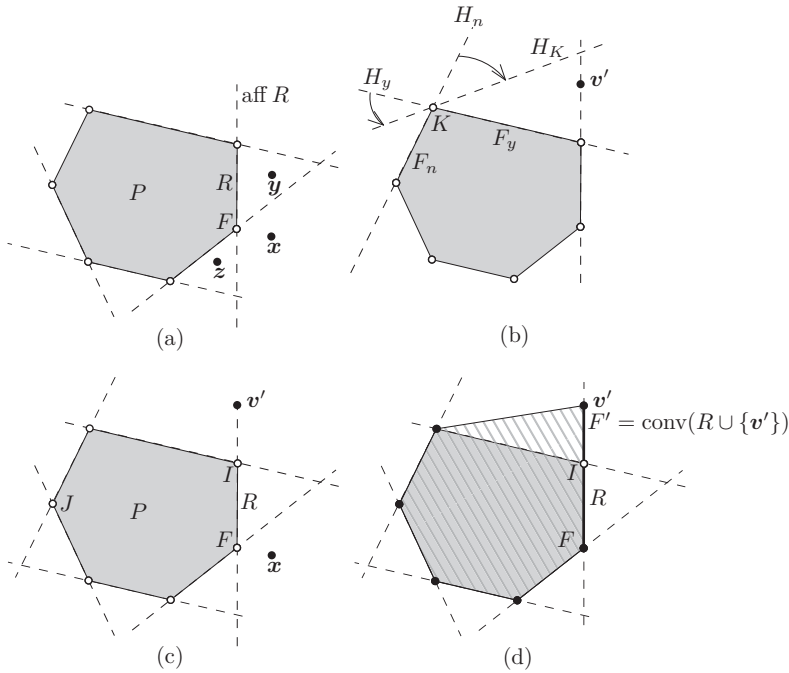

Figure 2.10.1 Inductive construction of polytopes. (a) The facet  $R$  of  $P$  is visible from the point  $x$  and nonvisible from the point  $z$ . The point  $x$  is beyond the face  $F$  but the points  $y$  and  $z$  are not. (b) Auxiliary figure for the proof of Theorem 2.10.1(iii). (c) The four cases of the proof of Theorem 2.10.1(iv). All the facets of  $P$  containing  $F$  are visible from  $x$  (Case (1)). All the facets of  $P$  containing  $J$  are nonvisible from  $x$  (Case (2)). All the facets of  $P$  containing  $I$  are visible from  $v'$  or contain  $v'$  in their affine hull and at least one such facet contains  $v'$  in their affine hull (Case (3)). All the facets of  $P$  containing  $F$  are nonvisible from  $v'$  or contain  $v'$  in their affine hull and at least one such facet contains  $v'$  in their affine hull (Case (4)). (d)  $P' := \text{conv}(P \cup \{v'\})$ . The polytope  $P$  is highlighted in grey and the polytope  $P'$  is highlighted in a tiling pattern.

respect to either  $P$  or  $P'$ ). As a consequence, each face  $F$  of  $P$  that is in such a facet  $J$  will be a face of  $P'$ . Now consider a face  $F$  of  $P$  and  $P'$ . Then  $F$  does not contain  $v'$ . Since  $F$  is the intersection of all the facets of  $P'$  that contain it,  $F$  is in some facet  $J'$  of  $P'$  that does not contain  $v'$ . The point  $v'$  is a vertex of  $P'$ , which implies that  $J'$  is nonvisible from  $v'$  with respect to  $P'$ . Hence the facet  $J'$  is facet of  $P$  that is nonvisible from  $v'$  with respect to  $P$ . This proves (i).

(ii)–(iii) Suppose that  $F$  is a face of  $P$  that satisfies (ii) or (iii). We establish that  $F' := \text{conv}(F \cup \{v'\})$  is a face of  $P'$ . First, suppose that  $F$  satisfies (ii).

Then a supporting hyperplane of  $P$  at  $F$  will be a supporting hyperplane of  $P'$  at  $F'$ , ensuring that  $F'$  is a face of  $P'$ . So assume that the condition (iii) holds.

Let  $F_y$  be a facet of  $P$  that contains  $F$  and is visible from  $\mathbf{v}'$  and let  $F_n$  be a facet of  $P$  that contains  $F$  and is nonvisible from  $\mathbf{v}'$ . Then  $F \subseteq F_y \cap F_n$ . Suppose that  $H_F$  is a supporting hyperplane of  $P$  at  $F$ ,  $H_y := \text{aff } F_y$ , and  $H_n := \text{aff } F_n$ . Rotate  $H_y$  and  $H_n$  slightly around  $H_y \cap H_F$  and  $H_n \cap H_F$ , respectively, and towards  $H_F$  (see Fig. 2.10.1(b)) in such a way that the two resulting hyperplanes  $H'_y$  and  $H'_n$  remain visible and nonvisible from  $\mathbf{v}'$  (with respect to  $P$ ) and that  $H'_y \cap P = H'_n \cap P = F$ . The hyperplanes  $H'_y$  and  $H'_n$  allow us to define a new hyperplane  $H'_F := \text{aff}(\{\mathbf{v}'\} \cup (H'_y \cap H'_n))$  that contains  $\mathbf{v}'$  and intersects  $P$  at  $F$  (since  $H'_y \cap P = H'_n \cap P = F$ ). It follows that

$$H'_F \cap P' = H'_F \cap \text{conv}(P \cup \{\mathbf{v}'\}) = \text{conv}(F \cup \{\mathbf{v}'\}) = F',$$

which shows that  $F'$  is a face of  $P'$ .

(iv) Let  $F'$  be a proper face of  $P'$  such that none of (i), (ii), or (iii) applies. Then  $F' = \text{conv}(F \cup \{\mathbf{v}'\})$  for some face  $F$  of  $P$ , as the case of  $F'$  being a face of  $P$  is covered in (i). We can further assume that  $\mathbf{v}' \notin \text{aff } F$ , as  $\mathbf{v}' \in \text{aff } F$  is covered in (ii). We (naively) list all the possibilities for the relative position of  $\mathbf{v}'$  and the facets of  $P$  containing  $F$  (Fig. 2.10.1(c)):

- (1) all the facets of  $P$  containing  $F$  are visible from  $\mathbf{v}'$ ,
- (2) all the facets of  $P$  containing  $F$  are nonvisible from  $\mathbf{v}'$ ,
- (3) all the facets of  $P$  containing  $F$  are visible from  $\mathbf{v}'$  or contain  $\mathbf{v}'$  in their affine hull, and at least one such facet contains  $\mathbf{v}'$  in their affine hull (see the face  $I$  and vertex  $\mathbf{v}'$  on Fig. 2.10.1(c)), and
- (4) all the facets of  $P$  containing  $F$  are nonvisible from  $\mathbf{v}'$  or contain  $\mathbf{v}'$  in their affine hull, and at least one such facet contains  $\mathbf{v}'$  in their affine hull (see the face  $F$  and vertex  $\mathbf{v}'$  on Fig. 2.10.1(c)).

The cases (1), (2), and (3) are not real alternatives, as  $F'$  is a face of  $P'$  for which none of (i), (ii), or (iii) holds; see Fig. 2.10.1(c). Case (4) can certainly happen. In case (4), for each facet  $J$  of  $P$  that contains  $\mathbf{v}'$  in their affine hull, we must have that  $\text{aff } J$  is a supporting hyperplane of  $P'$  (and of  $P$ ). It must then follow that there is a proper face  $R$  of  $P$  that contains  $\mathbf{v}'$  in the affine hull and is of the form  $R = H \cap P$  for some supporting hyperplane  $H$  of  $P'$  (and of  $P$ ); see Fig. 2.10.1(d). Hence (ii) applies, and  $F' = \text{conv}(R \cup \{\mathbf{v}'\})$ . This completes the proof of the theorem. □

We mention that there was a mistake in the original proof of Grünbaum (1963, thm. 5.2.1); Case (4) of our proof of Theorem 2.10.1(iv) is overlooked.

However, Case (4) cannot arise if  $\text{conv}(F \cup \{v'\})$  is a facet of  $P'$ ; this and other consequences of Theorem 2.10.1 ensue.

**Corollary 2.10.2** (Altshuler and Shemer, 1984) *Let  $P$  and  $P'$  be two  $d$ -polytopes in  $\mathbb{R}^d$ , and let  $v'$  be a vertex of  $P'$  such that  $v' \notin P$  and  $P' = \text{conv}(P \cup \{v'\})$ . Then the following hold:*

- (i)  $\mathcal{V}(P') = \mathcal{V}(P) \cup \{v'\}$  if and only if every vertex of  $P$  is in a facet of  $P$  that is nonvisible from  $v'$ .
- (ii) A facet  $F$  of  $P$  is a facet of  $P'$  if and only if it is nonvisible from  $v'$ .
- (iii) The set  $\text{conv}(F \cup \{v'\})$  is a facet of  $P'$  if and only if either  $v' \in \text{aff } F$  or among the facets of  $P$  containing  $F$  there is at least one that is visible from  $v'$  (with respect to  $P$ ) and at least one that is nonvisible (with respect to  $P$ ).

We end this section with two applications of Theorem 2.10.1; each describes an algorithm that changes the combinatorial structure of a polytope.

Let  $P$  be a  $d$ -polytope in  $\mathbb{R}^d$  and let  $v$  be a vertex of  $P$ . Further, let  $v'$  be a point outside  $P$  such that the halfopen segment  $(v, v']$  does not intersect any hyperplane spanned by the vertices of  $P$ . In the case that  $v$  belongs to the interior of  $P' := \text{conv}(P \cup \{v'\})$ , we say that  $P'$  is obtained from  $P$  by *pulling  $v$  to  $v'$* . The position of  $v'$  ensures that  $v'$  is beyond  $v$ . The next result follows at once from Theorem 2.10.1.

**Theorem 2.10.3** (Pulling vertices; Eggleston et al., 1964) *Let  $P'$  be a  $d$ -polytope in  $\mathbb{R}^d$  obtained from a  $d$ -polytope  $P$  by pulling a vertex  $v$  of  $P$  to a vertex  $v'$  of  $P'$ . Then, for each  $k \in [1 \dots d - 1]$ , the  $k$ -faces of  $P'$  are as follows:*

- (i) The  $k$ -faces of  $P$  that do not contain  $v$ .
- (ii) The pyramid  $\text{conv}(F \cup \{v'\})$  for each  $(k - 1)$ -face  $F$  of  $P$  that does not contain  $v$  but belongs to a facet of  $P$  that contains  $v$ .

Moreover,  $f_0(P') = f_0(P)$  and  $f_k(P') \geq f_k(P)$  for each  $k \in [1 \dots d - 1]$ .

Repeated applications of Theorem 2.10.3 transform any  $d$ -polytope  $P$  into a simplicial polytope with the same number of vertices as  $P$  and at least as many faces of higher dimension. We state the result.

**Theorem 2.10.4** *Let  $Q$  be a  $d$ -polytope obtained from a  $d$ -polytope  $P$  by successively pulling each of the vertices of  $P$ . Then the following hold:*

- (i) The polytope  $Q$  is a simplicial  $d$ -polytope satisfying  $f_0(Q) = f_0(P)$ , and  $f_k(Q) \geq f_k(P)$  for each  $k \in [1 \dots d - 1]$ .

- (ii) If some  $i$ -face of  $P$  is not a simplex, then  $f_k(Q) > f_k(P)$  for each  $k \in [i - 1 \dots d - 1]$ .

‘Pushing’ a vertex into the interior of a polytope yields a similar outcome to that of pulling the vertex into the exterior of the polytope. Let  $P$  be a  $d$ -polytope in  $\mathbb{R}^d$  and let  $\mathbf{v}$  be a vertex of  $P$ . Further, let  $H_{\mathbf{v}}$  be a hyperplane that separates  $\mathbf{v}$  from the other vertices of  $P$  and let  $\mathbf{v}' \in \text{int } P \cap H_{\mathbf{v}}$  so that  $\mathbf{v}'$  is at Euclidean distance at most  $\varepsilon$  from  $\mathbf{v}$  and no hyperplane spanned by vertices of  $P$  intersects the halfopen segment  $(\mathbf{v}, \mathbf{v}']$ . In this case, we say that the polytope  $P' := \text{conv}((\mathcal{V}(P) \setminus \{\mathbf{v}\}) \cup \{\mathbf{v}'\})$  is obtained from  $P$  by *pushing*  $\mathbf{v}$  to  $\mathbf{v}'$ . The next theorem is an analogue of Theorem 2.10.3. A proof, however, does not follow from Theorem 2.10.1, and so we give one.

**Theorem 2.10.5** (Pushing vertices; Klee, 1964b, sec. 2) *Let  $P'$  be a  $d$ -polytope in  $\mathbb{R}^d$  obtained from a  $d$ -polytope  $P$  by pushing a vertex  $\mathbf{v}$  of  $P$  to a point  $\mathbf{v}'$ . Then the following hold:*

- (i) *The  $k$ -faces of  $P$  that do not contain  $\mathbf{v}$  are all  $k$ -faces of  $P'$ .*
- (ii) *For each pyramidal  $k$ -face  $F$  of  $P$  with apex  $\mathbf{v}$ , the pyramid*

$$\text{conv}((F \setminus \{\mathbf{v}\}) \cup \{\mathbf{v}'\})$$

*is a  $k$ -face of  $P'$ .*

- (iii)  $\mathcal{V}(P') = (\mathcal{V}(P) \setminus \{\mathbf{v}\}) \cup \{\mathbf{v}'\}$ .
- (iv) *For each  $k$ -face  $F$  of  $P$  that contains  $\mathbf{v}$  but is not a pyramid with apex  $\mathbf{v}$ , the set  $\text{conv}(F \setminus \{\mathbf{v}\})$  is a  $k$ -face of  $P'$ .*
- (v) *Each proper face of  $P'$  containing  $\mathbf{v}'$  is a pyramid with apex  $\mathbf{v}'$ .*

Moreover,  $f_0(P') = f_0(P)$  and  $f_k(P') \geq f_k(P)$  for each  $k \in [1 \dots d - 1]$ .

*Proof* Let  $F$  be a  $k$ -face of  $P$  and let  $H_F$  be a hyperplane supporting  $P$  at  $F$ . As  $P' \subset P$ , the hyperplane  $H_F$  doesn't meet the interior of  $P'$ . It follows that  $F = H_F \cap P = H_F \cap P'$  is a  $k$ -face of  $P'$  if  $\mathbf{v} \notin F$ ; this proves (i). So assume that  $\mathbf{v} \in F$ .

We consider what happens when we continuously move  $\mathbf{v}$  to  $\mathbf{v}'$  along the segment  $[\mathbf{v}, \mathbf{v}']$ ; at time  $t = 0$  we have  $\mathbf{v}$  and at time  $t = 1$  we have  $\mathbf{v}'$ . Let  $H_F(t)$  be the hyperplane obtained at time  $t$  from moving  $H_F$  together with  $\mathbf{v}$ ; here,  $H_F(0) = H_F$ . Similarly define  $P(t)$  and  $F(t)$  so that  $P(0) = P$ ,  $P(1) = P'$ , and  $F(0) = F$ . Since  $F(0) = F$  is a face of  $P(0) = P$ , Theorem 2.3.7 ensures that

$$\text{aff } \mathcal{V}(F(t)) \cap \text{conv}(\mathcal{V}(P(t)) \setminus \mathcal{V}(F(t))) = \emptyset \tag{2.10.5.1}$$

at time  $t = 0$ . If we move  $\mathbf{v}(t)$  continuously from  $t = 0$  to  $t = 1$  by a sufficiently small amount, then  $\text{aff } \mathcal{V}(F(t))$  and  $H_F(t)$  also move continuously.

(ii) First, suppose that  $F$  is a pyramid with apex  $\mathbf{v}$  and base  $R$ . Then  $R = \text{conv}(F \setminus \{\mathbf{v}\})$  is a  $(k - 1)$ -face of both  $P$  and  $P'$  by (i). Additionally,  $\mathbf{v}' \notin \text{aff } \mathcal{V}(R)$  by the assumption that no hyperplane spanned by vertices of  $P$  intersects the segment  $(\mathbf{v}, \mathbf{v}']$ . Therefore, (2.10.5.1) becomes

$$\text{aff}(\mathcal{V}(R) \cup \{\mathbf{v}(t)\}) \cap \text{conv}(\mathcal{V}(P(t)) \setminus (\mathcal{V}(R) \cup \{\mathbf{v}(t)\})) = \emptyset$$

for each  $t \in [0, 1]$ . Hence  $\text{conv}(\mathcal{V}(R) \cup \{\mathbf{v}(t)\})$  is a  $k$ -face of  $P(t)$  for each  $t \in [0, 1]$ . In the particular case  $t = 1$ , we have (ii).

(iii) This follows at once from (i) and (ii): every vertex of  $P$  other than  $\mathbf{v}$  is a vertex of  $P'$  by (i), while  $\mathbf{v}'$  is a vertex of  $P'$  by (ii).

(iv) Now suppose that  $F$  is not a pyramid with apex  $\mathbf{v}$ . Since  $F$  is a face of  $P$ , at time  $t = 0$  (2.10.5.1) becomes

$$\text{aff } \mathcal{V}(F) \cap \text{conv}(\mathcal{V}(P(t)) \setminus \mathcal{V}(F)) = \emptyset.$$

We also have that  $\text{aff}(\mathcal{V}(F) \setminus \{\mathbf{v}\}) = \text{aff } \mathcal{V}(F)$ , and so  $\mathbf{v} \in \text{aff}(\mathcal{V}(F) \setminus \{\mathbf{v}\})$ . Therefore, using the assumption that no hyperplane spanned by vertices of  $P$  intersects the segment  $(\mathbf{v}, \mathbf{v}']$  and the fact that  $\mathbf{v} \notin P(t)$  for each  $t \in (0, 1]$ , we obtain that

$$\text{aff}(\mathcal{V}(F) \setminus \{\mathbf{v}\}) \cap \text{conv}(\mathcal{V}(P(t)) \setminus (\mathcal{V}(F) \setminus \{\mathbf{v}\})) = \emptyset, \text{ for each } t \in (0, 1].$$

Hence  $\text{conv}(F \setminus \{\mathbf{v}\})$  is a  $k$ -face of  $P(t)$  for each  $t \in (0, 1]$ . In the particular case  $t = 1$  we have (iv).

(v) Suppose that  $F'$  is a proper face of  $P'$  that contains  $\mathbf{v}'$  and yet is not a pyramid with apex  $\mathbf{v}'$ . If  $J'$  is a facet of  $P'$  containing  $F'$ , then  $\mathbf{v}'$  belongs to  $\text{aff } J'$ , which is spanned by  $\mathcal{V}(J') \cap \mathcal{V}(P)$ . This contradicts the definition of pushing. □

A corollary follows at once.

**Corollary 2.10.6** *Let  $Q$  be a  $d$ -polytope obtained from a  $d$ -polytope  $P$  by successively pushing each of the vertices of  $P$ . Then the following hold.*

- (i) *The polytope  $Q$  is a simplicial  $d$ -polytope satisfying  $f_0(Q) = f_0(P)$  and  $f_k(Q) \geq f_k(P)$  for each  $k \in [1 \dots d - 1]$ .*
- (ii) *If some  $k$ -face of  $P$  is not a pyramid, then  $f_k(Q) > f_k(P)$ .*

The same idea behind the proof of Theorem 2.10.5 proves the following variation by Santos (2012).



**Theorem 2.10.7** (Santos, 2012, lem. 2.2) *Let  $P'$  be a  $d$ -polytope in  $\mathbb{R}^d$  obtained from a  $d$ -polytope  $P$  by pushing a vertex  $\mathbf{v}$  of  $P$  to a point  $\mathbf{v}'$ . Then there exists a map  $\varphi$  from the facets of  $P'$  to the facets of  $P$  that satisfies the following:*

- (i) *If  $F'$  is a facet of  $P'$  such that  $\mathbf{v}' \in F'$ , then there is a unique facet  $\varphi(F')$  of  $P$  such that  $(\mathcal{V}(F') \setminus \{\mathbf{v}'\}) \cup \{\mathbf{v}\} \subseteq \mathcal{V}(\varphi(F'))$ .*
- (ii) *If  $F'$  is a facet of  $P'$  such that  $\mathbf{v}' \notin F'$ , then there is a unique facet  $\varphi(F')$  of  $P$  such that  $\mathcal{V}(F') \subseteq \mathcal{V}(\varphi(F'))$ .*
- (iii) *The map  $\varphi$  sends two facets  $F'_1$  and  $F'_2$  of  $P'$  that share a ridge either to the same facet of  $P$  or to two facets  $\varphi(F'_1)$  and  $\varphi(F'_2)$  of  $P$  that share a ridge.*

Repeatedly pulling the vertices of a polytope transforms it into a simplicial polytope (Theorem 2.10.4), and so does repeatedly pushing its vertices (Corollary 2.10.6). Dually, every polytope can be transformed into a simple polytope by truncating the vertices, then the original edges, and so on up to ridges (Problem 2.15.12).

## 2.11 Complexes, Subdivisions, and Schlegel Diagrams

Polytopal complexes, a concept borrowed from algebraic topology, will prove useful in our study of polytopes. Among other purposes, we will use them to visualise polytopes via Schlegel diagrams, establish the existence of shellings of polytopes (Section 2.12), and prove identities such as Euler–Poincaré–Schläfli’s equation for polytopes (Theorem 2.12.17). We proceed with the basic definitions related to polytopal complexes.

**Definition 2.11.1** (Polytopal complex) *A polytopal complex  $\mathcal{C}$  is a finite, nonempty collection of polytopes in  $\mathbb{R}^d$  that satisfies the following three conditions:*

- (i) *the empty polytope is always in  $\mathcal{C}$ ,*
- (ii) *the faces of each polytope in  $\mathcal{C}$  all belong to  $\mathcal{C}$ , and*
- (iii) *polytopes intersect only at faces: if  $P_1 \in \mathcal{C}$  and  $P_2 \in \mathcal{C}$  then  $P_1 \cap P_2$  is a face of both  $P_1$  and  $P_2$ .*

A complex  $\mathcal{C}$  with members  $\{P_1, \dots, P_n\}$  is said to be a complex on  $\{P_1, \dots, P_n\}$ . The *underlying set* of  $\mathcal{C}$ , denoted  $\text{set } \mathcal{C}$ , is the set of points in  $\mathbb{R}^d$  that belong to at least one polytope in  $\mathcal{C}$ .

If a polytope is a member of a complex  $\mathcal{C}$ , we say that the polytope is a *face* of the complex. The *dimension* of a complex  $\mathcal{C}$  is the largest dimension of a face in  $\mathcal{C}$ ; if  $\mathcal{C}$  has dimension  $d$  we say that  $\mathcal{C}$  is a  $d$ -*complex*. The set of  $k$ -faces of a complex  $\mathcal{C}$  is denoted by  $\mathcal{F}_k(\mathcal{C})$  and the set of all faces of  $\mathcal{C}$  is denoted by  $\mathcal{F}(\mathcal{C})$ . Additionally, the number of  $k$ -faces is denoted by  $f_k(\mathcal{C})$ :  $f_k(\mathcal{C}) = \#\mathcal{F}_k(\mathcal{C})$ . As with the case of polytopes, we denote by  $\mathcal{V}(\mathcal{C})$  the set of vertices of  $\mathcal{C}$  and by  $\mathcal{E}(\mathcal{C})$  the set of edges of  $\mathcal{C}$ . Faces of a complex of largest and second largest dimension are called *facets* and *ridges*, respectively. If each of the faces of a complex is contained in some facet, we say that the complex is *pure*.

We mention two important families of polytopal complexes. A *simplicial complex*  $\mathcal{C}$  is a polytopal complex in  $\mathbb{R}^d$  where all its polytopes are simplices. A *cubical complex*  $\mathcal{C}$  is a polytopal complex in  $\mathbb{R}^d$  where all its polytopes are cubes.

A *subcomplex* of a polytopal complex  $\mathcal{C}$  is a subset of  $\mathcal{C}$  that is itself a polytopal complex. A subcomplex of dimension  $k$  is a  $k$ -*subcomplex*. This book is concerned only with polytopal complexes, and so we often drop the adjective ‘polytopal’. The undirected graph formed by the vertices and edges of  $\mathcal{C}$ , denoted by  $G(\mathcal{C})$ , is the *graph* of the complex  $\mathcal{C}$ .

For two polytopal complexes  $\mathcal{C}$  and  $\mathcal{C}'$ , define their *intersection*  $\mathcal{C} \cap \mathcal{C}'$  as the collection of polytopes in  $\mathcal{C}$  and  $\mathcal{C}'$ , and their *union*  $\mathcal{C} \cup \mathcal{C}'$  as the collection of polytopes in  $\mathcal{C}$  or  $\mathcal{C}'$ . The intersection  $\mathcal{C} \cap \mathcal{C}'$  is always a complex, and the union  $\mathcal{C} \cup \mathcal{C}'$  is a complex if the intersections  $P \cap P'$  with  $P \in \mathcal{C}$  and  $P' \in \mathcal{C}'$  are all polytopes in  $\mathcal{C} \cap \mathcal{C}'$ .

Complexes can be defined from a polytope  $P$ . Two basic examples are given by the complex of all faces of  $P$ , called the *complex* of  $P$  and denoted by  $\mathcal{C}(P)$ , and the complex of all proper faces of  $P$ , called the *boundary complex* of  $P$  and denoted by  $\mathcal{B}(P)$ . The  $k$ -*skeleton*  $\mathcal{B}_k$  of a  $d$ -polytope  $P$  is the subcomplex formed by the faces of dimension at most  $k$ ; the  $(d-1)$ -skeleton of  $P$  coincides with the boundary complex of  $P$ , while the 1-skeleton of  $P$  coincides with the graph  $G(P)$  of  $P$ .

Similarly, a complex can be defined from a set  $\{P_1, \dots, P_n\}$  of polytopes, where each pair intersects at a common face, by forming the complex the complex  $\mathcal{C}(P_1) \cup \dots \cup \mathcal{C}(P_n)$ . In this case, we say that the complex is *induced* by  $\{P_1, \dots, P_n\}$ , and denote it as  $\mathcal{C}(P_1 \cup \dots \cup P_n)$ .

The *face poset*  $\mathcal{L}(\mathcal{C})$  of a complex  $\mathcal{C}$  is the poset formed by the set of faces of  $\mathcal{C}$  partially ordered by inclusion. Two complexes  $\mathcal{C}$  and  $\mathcal{C}'$  are *combinatorially isomorphic*, or simply *isomorphic*, if their face posets are isomorphic. For isomorphic complexes, we write  $\mathcal{C} = \mathcal{C}'$ .

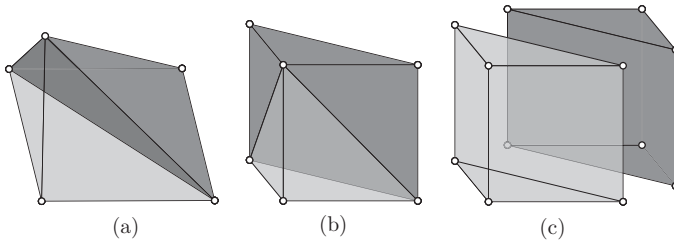

Figure 2.11.1 Triangulations of 3-polytopes. (a) A triangulation of a pyramid over a quadrangle with two 3-simplices. (b) A triangulation of a simplicial 3-prism  $P$  with three 3-simplices: first divide  $P$  into a 3-simplex and a pyramid  $R$  over a quadrangle, then triangulate  $R$  as in (a). (c) An initial step in a triangulation of a 3-cube  $Q$  with six 3-simplices: first divide  $Q$  into two simplicial 3-prisms, then triangulate each prism with three 3-simplices as in (b).

## Subdivisions

Polytopal subdivisions are an important kind of polytopal complexes. In general, they come into play when we want to decompose a geometric object into simpler pieces, reducing the geometry to a simpler piecewise geometry. This is the case of Delaunay subdivisions (Goodman et al., 2017, sec. 16.3, ch. 27) in computational geometry. Triangulations are the most studied subdivisions. They have found applications in computational geometry via mesh generations (Goodman et al., 2017, sec. 29.4, 29.5), in commutative algebra in connection with Gröbner bases (Sturmfels, 1996), in tropical geometry via tropical hyperplane arrangements (Ardila and Develin, 2009), and in optimisation in connection with transportation polytopes (De Loera et al., 2009).

A *polytopal subdivision*  $\mathcal{S}$  of a  $d$ -polytope  $P$  in  $\mathbb{R}^d$  is a pure polytopal  $d$ -complex with the same underlying set as  $P$ . A polytopal subdivision is a *triangulation* if all the polytopes in  $\mathcal{S}$  are simplices; see Fig. 2.11.1. Two polytopal subdivisions are *combinatorially isomorphic* if they are combinatorially isomorphic as polytopal complexes.

Some subdivisions can be obtained from projecting a polytope in  $\mathbb{R}^{d+1}$  to  $\mathbb{R}^d$ ; these are the regular subdivisions. Suppose that a polytope  $Q$  in  $\mathbb{R}^d$  is the image of a polytope  $P$  in  $\mathbb{R}^{d+1}$  under the projection  $\pi$  that deletes the last coordinate (namely  $\pi(\mathbf{x}, x_{d+1}) = \mathbf{x}$ ). A face  $F$  of the polytope  $P$  is a *lower face* of  $P$  if  $\mathbf{x} - \lambda \mathbf{e}_{d+1} \notin P$  for each point  $\mathbf{x} \in F$  and each  $\lambda > 0$ . Equivalently,  $F$  is a lower face of  $P$  if, for a vector  $\mathbf{r} := (r_1, \dots, r_{d+1})^t \in \mathbb{R}^{d+1}$ , we have that

$$F = \{\mathbf{x} \in P \mid \mathbf{r} \cdot \mathbf{x} = \gamma\}, \mathbf{r} \cdot \mathbf{x} \leq \gamma \text{ is valid for } P, \text{ and } r_{d+1} < 0.$$

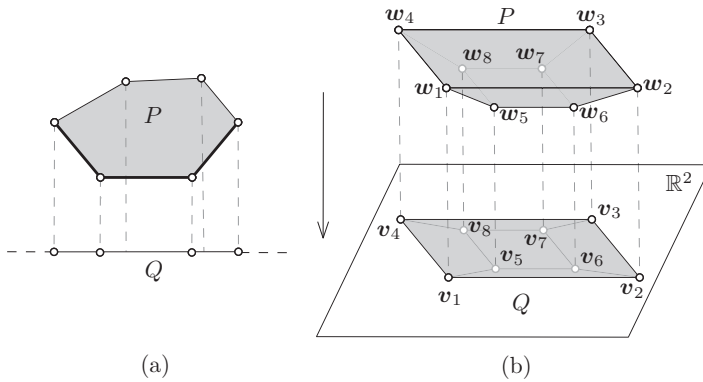

$$\begin{matrix} w_1 = (v_1, y_1)^t & w_2 = (v_2, y_2)^t & w_3 = (v_3, y_3)^t & w_4 = (v_4, y_4)^t \\ w_5 = (v_5, y_5)^t & w_6 = (v_6, y_6)^t & w_7 = (v_7, y_7)^t & w_8 = (v_8, y_8)^t \end{matrix}$$

Figure 2.11.2 Regular subdivisions of polytopes. (a) A regular subdivision of a segment  $Q$  that arises from a 2-polytope  $P$ . (b) A regular subdivision of a 2-polytope  $Q := \text{conv}\{v_1, \dots, v_8\}$  that arises from a 3-cube  $P := \text{conv}\{w_1, \dots, w_8\}$ ; the lift vector  $y := (y_1, \dots, y_8)^t$ .

This amounts to saying that  $F$  can be seen from a point far below, namely from a point  $-\alpha e_{d+1}$  with sufficiently large  $\alpha$ . The set of lower faces of  $P$  is the *lower envelope* of  $P$ . A polytopal subdivision  $S$  of the polytope  $Q$  in  $\mathbb{R}^d$  is *regular* if it is the set of projections of all the lower faces of  $P$ :

$$S(Q) = \{\pi(F) \mid F \text{ is a lower face of } P\}.$$

See Figure 2.11.2. An equivalent definition of a regular subdivision of  $Q$  in  $\mathbb{R}^d$  uses a *lift vector*  $y = (y_1, \dots, y_n)^t \in \mathbb{R}^n$  to define the vertex set of  $P$ . Suppose that  $Q = \text{conv}\{v_1, \dots, v_n\}$ , and for each  $i \in [1 \dots n]$  let  $w_i := (v_i, y_i)^t \in \mathbb{R}^{d+1}$ . We say that a subdivision of  $Q$  is regular if it is combinatorially isomorphic to the lower envelope of the polytope  $P := \text{conv}\{w_1, \dots, w_n\}$ ; see Fig. 2.11.2(b). Being regular is not a combinatorial property; there are pairs of subdivisions that are combinatorially isomorphic and yet one is nonregular and the other is regular, as Fig. 2.11.3 and Example 2.11.2 show.

Every subdivision of a 1-polytope is regular and so are the subdivisions of a 2-polygon without interior points. It is also the case that every subdivision of a  $d$ -polytope that is the convex hull of at most  $d + 3$  points, vertices or otherwise, is regular (Lee, 1991). But there are subdivisions of 2-polygons with six points, vertices or otherwise, that are not regular (Fig. 2.11.3). Example 2.11.2 explores this situation.

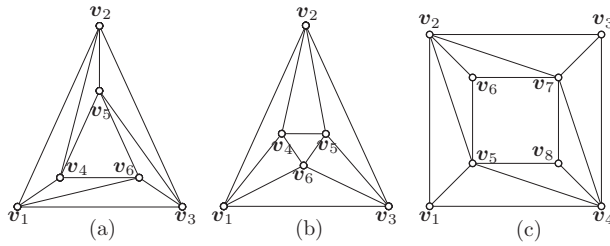

Figure 2.11.3 Regular and nonregular subdivisions of 2-polytopes with interior points. (a) A nonregular triangulation. (b) A regular triangulation that is combinatorially isomorphic to the triangulation in (a); it is the Schlegel diagram of the 3-crosspolytope. (c) A regular subdivision that is not a Schlegel diagram.

**Example 2.11.2** Consider the three subdivisions of Fig. 2.11.3 and suppose that they lie in the hyperplane  $x_3 = 0$  of  $\mathbb{R}^3$ .

(a) We show that the subdivision  $\mathcal{S}_a$  of Fig. 2.11.3(a) is nonregular. Suppose that  $\mathcal{S}_a$  is regular with vertex set  $\{v_1, \dots, v_6\}$  and lift vector  $\mathbf{y} = (y_1, \dots, y_6)^t$  such that  $\mathcal{S}_a$  is the set of projections of the lower faces of the 3-polytope  $P_a := \text{conv}\{(v_1, y_1)^t, \dots, (v_6, y_6)^t\}$ . By assumption, the interior triangle  $v_4v_5v_6$  of  $\mathcal{S}_a$  is the projection of a triangular face  $F$  of  $P_a$  that lies in a plane in  $\mathbb{R}^3$ , and so we may assume that the three components  $y_4, y_5, y_6$  have the same value, say zero; this may require applying an affine transformation to  $P$ , for instance a rotation, so that  $\text{aff } F$  becomes parallel to the plane  $x_3 = 0$ . From Fig. 2.11.3(a) we see that the segments  $[v_1, v_2]$  and  $[v_4, v_5]$  are parallel. This implies that if  $y_1 = y_2$  then the trapezoid  $v_1v_2v_4v_5$  of  $\mathcal{S}_a$  would come from the 2-face  $(v_1, y_1)^t, (v_2, y_2)^t, (v_4, y_4)^t, (v_5, y_5)^t$  of  $P_a$ , which disregards the existence of the edge  $[v_2, v_4]$ . Because the edge  $[v_2, v_4]$  is present, we must have that  $y_1 > y_2$ . Similar reasoning on the trapezoids  $v_2v_3v_5v_6$  and  $v_1v_3v_4v_6$  yields that  $y_2 > y_3$  and  $y_3 > y_1$ , respectively. Thus, we have that  $y_1 > y_2 > y_3 > y_1$ , a contradiction. Hence  $\mathcal{S}_a$  is a nonregular subdivision.

(b) The subdivision  $\mathcal{S}_b \in \mathbb{R}^2$  of Fig. 2.11.3(a) is combinatorially isomorphic to the subdivision  $\mathcal{S}_a$ . That  $\mathcal{S}_b \in \mathbb{R}^2$  is regular follows from being a Schlegel diagram (Proposition 2.11.10).

(c) We show that the subdivision  $\mathcal{S}_c \in \mathbb{R}^2$  of Fig. 2.11.3(c) is regular. Suppose that  $\mathcal{S}_c$  has vertex set  $\{v_1, \dots, v_8\}$  and lift vector  $\mathbf{y} = (y_1, \dots, y_8)^t$  such that  $\mathcal{S}_c$  is the set of projections of the lower faces of the 3-polytope  $P_c := \text{conv}\{(v_1, y_1)^t, \dots, (v_8, y_8)^t\}$ . The interior quadrangle  $v_5v_6v_7v_8$  of  $\mathcal{S}_c$  comes from a quadrangular face of  $P_c$  and so we may assume that the four components  $y_5, y_6, y_7, y_8$  have the same value, say zero. If we consider the trapezoid  $v_1v_2v_5v_6$  and reason as in the case (a), we have that  $y_1 > y_2$ .

Similarly, the trapezoids  $v_2v_3v_6v_7$ ,  $v_3v_4v_7v_8$ ,  $v_1v_4v_5v_8$  yield that  $y_3 > y_2$ ,  $y_3 > y_4$ , and  $y_1 > y_4$ , respectively. Meeting these constraints gives a suitable lift vector, say  $y_1 = 2, y_2 = 1, y_3 = 2, y_4 = 1$ . The existence of the lift vector  $\mathbf{y}$  shows that  $\mathcal{S}_c$  is regular.

### Schlegel Diagrams

Schlegel diagrams are regular subdivisions of a facet of a polytope that capture the combinatorics of the polytope and, as such, they will help visualise 3-polytopes and 4-polytopes.

We first define the basic elements of a Schlegel diagram. Let  $P$  be a  $d$ -polytope in  $\mathbb{R}^d$  and let  $F$  be a facet of  $P$  whose affine hull is defined by the equation  $\mathbf{r} \cdot \mathbf{x} = \gamma$ . Choose a point  $\mathbf{y}_F \in \mathbb{R}^d$  beyond  $F$  and consider the segment  $\ell(\mathbf{x}) := [\mathbf{y}_F, \mathbf{x}]$  from  $\mathbf{y}_F$  to every point  $\mathbf{x} \in P$ . We let  $\varphi(\mathbf{x})$  be the intersection of  $\ell(\mathbf{x})$  and  $F$ . Then

$$\varphi(\mathbf{x}) = \mathbf{y}_F + \frac{\gamma - \mathbf{r} \cdot \mathbf{y}_F}{\mathbf{r} \cdot \mathbf{x} - \mathbf{r} \cdot \mathbf{y}_F}(\mathbf{x} - \mathbf{y}_F). \quad (2.11.3)$$

We extend the function  $\varphi(\mathbf{x})$  to proper faces of  $P$ . To do so, for each proper face  $J$  we define an affine cone  $C_J$  with apex  $\mathbf{y}_F$  as

$$C_J := \{\mathbf{y}_F + \alpha(\mathbf{x} - \mathbf{y}_F) \mid \text{for each } \mathbf{x} \in J \text{ and each } \alpha \geq 0\}. \quad (2.11.4)$$

With the cone  $C_J$  in place, we have that

$$\varphi(J) := C_J \cap \text{aff } F. \quad (2.11.5)$$

See Fig. 2.11.4 for a depiction of the function  $\varphi$  and the cone  $C_J$  related to a face  $J$  of a polytope  $P$ .

A *Schlegel diagram of a polytope  $P$  based at the facet  $F$  of  $P$* , denoted by  $\mathcal{D}(P, F)$ , is the image under the aforementioned function  $\varphi$  of all the proper faces of  $P$  other than  $F$  (see (2.11.5)):

$$\mathcal{D}(P, F) = \{\varphi(J) \mid J \in \mathcal{L}(P) \setminus \{P, F\}\}. \quad (2.11.6)$$

For simplicity, we will also refer to  $\mathcal{D}(P, F)$  as the Schlegel diagram of  $P$  at  $F$ . The Schlegel diagram of  $P$  at  $F$  is a polytopal subdivision of  $F$  that captures the combinatorics of  $P$ , regardless of the point  $\mathbf{y}_F$  that we choose beyond the facet  $F$ , as the following theorem shows.

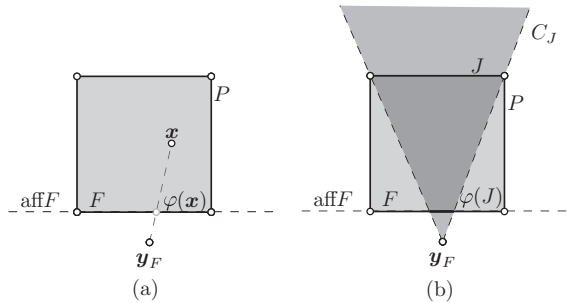

Figure 2.11.4 Definitions of the basic elements in the construction of Schlegel diagrams. (a) Definition of the function  $\varphi(x)$  for each vertex  $x$  of a polytope  $P$ . (b) Definition of the cone  $C_J$  and image  $\varphi(J)$  for a proper face  $J$  of  $P$ ; the image  $\varphi(J)$  is highlighted in bold.

**Theorem 2.11.7**<sup>7</sup> *Let  $P$  be a  $d$ -polytope in  $\mathbb{R}^d$  and  $F$  a facet of it. A Schlegel diagram of  $P$  at  $F$  is a polytopal subdivision of  $F$  that is combinatorially isomorphic to the complex  $\mathcal{B}(P) \setminus \{F\}$  of the proper faces of  $P$  other than  $F$ .*

Theorem 2.11.7 is illustrated in Fig. 2.11.5.

The face lattice  $\mathcal{L}(P)$  of a polytope  $P$  can be readily reconstructed from the Schlegel diagram  $\mathcal{D}(P, F)$  of  $P$  at a facet  $F$  of  $P$ . From  $F = \text{set } \mathcal{D}(P, F)$  and Theorem 2.11.7, we have that  $\mathcal{D}(P, F)$  is combinatorially isomorphic to  $\mathcal{B}(P) \setminus \{F\}$ . We construct the facet poset  $\mathcal{L}(\mathcal{D}(P, F) \cup \{F, P\}, \leq)$  whose faces are partially ordered by inclusion. In the poset  $\mathcal{L}(\mathcal{D}(P, F) \cup \{F, P\}, \leq)$ , a face  $R$  of  $\mathcal{D}(P, F)$  satisfies  $R \leq F$  if and only if  $R$  is a face of the facet  $F$ . We list three simple consequences of this discussion and Theorem 2.11.7.

**Corollary 2.11.8** *Let  $P$  be a  $d$ -polytope in  $\mathbb{R}^d$  and  $F$  a facet of it. Then the following hold.*

- (i) *The underlying set of  $\mathcal{D}(P, F)$  is  $F$ :  $\text{set } \mathcal{D}(P, F) = F$ .*
- (ii) *For every face  $R$  of  $\mathcal{D}(P, F)$ ,  $R \cap \text{rbd}F$  is a face of  $F$ .*
- (iii) *The face lattice  $\mathcal{L}(P)$  of  $P$  is combinatorially isomorphic to the face poset  $\mathcal{L}(\mathcal{D}(P, F) \cup \{F, P\}, \leq)$ .*

Similar to projective transformations, duality can be applied to produce combinatorially isomorphic polytopes with prescribed properties. The application of duality relies on two observations. First, polytopes  $P$  and  $x + P$  are combinatorially isomorphic, and so if they both have zero in their interior then their duals exist and are combinatorially isomorphic. Second, if the translation

<sup>7</sup> A proof is available in Ziegler (1995, prop. 5.6).

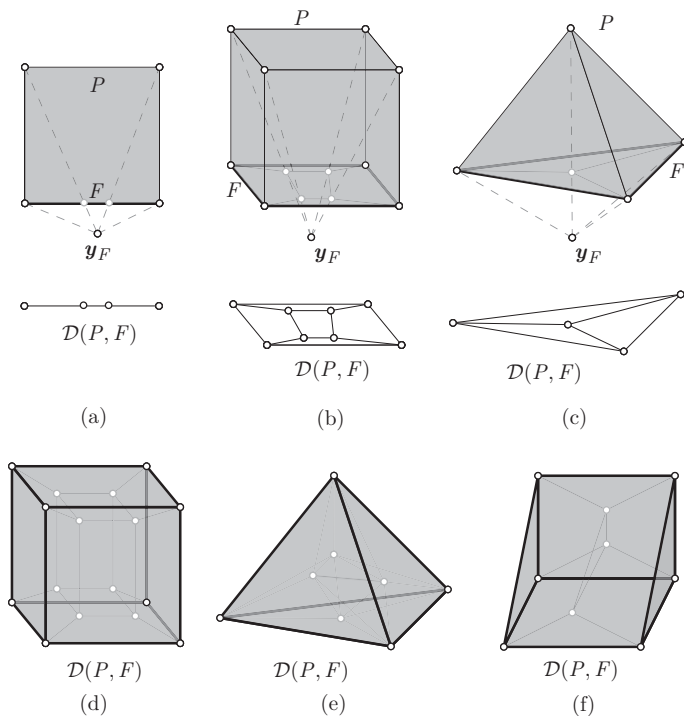

Figure 2.11.5 Schlegel diagrams of polytopes; the projection facet  $F$  has been highlighted in bold. (a) A quadrangle and one of its Schlegel diagrams. (b) A 3-cube and one of its Schlegel diagrams. (c) A 3-simplex and one of its Schlegel diagrams. (d) A Schlegel diagram of a 4-cube; the projection facet is a 3-cube. (e) A Schlegel diagram of a 4-crosspolytope; the projection facet is a 3-simplex. (f) A Schlegel diagram of the Cartesian product of a 2-simplex with another 2-simplex; the projection facet is a simplicial 3-prism.

vector  $\mathbf{x}$  is chosen so that a vertex in  $\mathbf{x} + P$  moves closer to  $\mathbf{0}$ , then the corresponding facet  $F$  in  $(\mathbf{x} + P)^*$  moves farther from the vertices in  $(\mathbf{x} + P)^*$  not in  $F$  (Fig. 1.11.1).

**Theorem 2.11.9** *Let  $P$  be a  $d$ -polytope in  $\mathbb{R}^d$  and let  $F$  be a facet of  $P$ . Then there is a  $d$ -polytope  $P_1$  combinatorially isomorphic to  $P$  such that, for the facet  $F_1$  of  $P_1$  corresponding to  $F$  under this isomorphism and for every vertex  $\mathbf{v}$  of  $P_1$  not on  $F_1$ , the orthogonal projection of  $\mathbf{v}$  onto  $F_1$  lies in the relative interior of  $F_1$ .*

We offer two proofs of this result, one via projective transformations and another via duality.



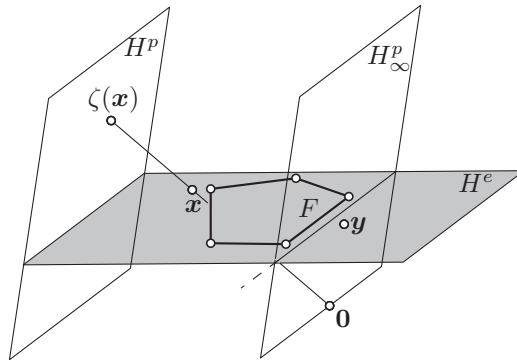

Figure 2.11.6 Projective transformation for Theorem 2.11.9.

*Proof via projective transformations* We follow the scheme described in Section 2.5. Pass to  $\mathbb{P}(\mathbb{R}^{d+1})$  and embed the polytope  $P$  in a nonlinear hyperplane  $H^e$ . Projectively complete  $H^e$  by adding the hyperplane at infinity  $H^e_\infty$ . The definitions of  $H^e$  and  $H^e_\infty$  are irrelevant, but if concrete definitions are desired, consult Section 2.5.

Choose a point  $y \in H^e$  beyond the facet  $F$  and a linear hyperplane  $H^p_\infty$  that strictly separates  $y$  and  $P$ ; this latter choice requires invoking the separation theorem (1.8.5). To finalise our scheme, select a nonlinear hyperplane  $H^p$  that is parallel to  $H^p_\infty$  and admissible for  $P$ , and let  $\zeta$  be a projective transformation admissible for  $P$  that fixes the points in  $H^e \cap H^p$  and sends each point in  $H^e \setminus (H^p \cup H^p_\infty)$  to the point in  $H^p$  lying on the same line through the origin (Fig. 2.5.1(a)); the transformation  $\zeta$  maps  $P$  onto a polytope  $P_1$  on  $H^p$ . See Fig. 2.11.6.

This transformation makes the facet  $F_1 := \zeta(F)$  of  $P_1$  very large and moves it far away from the vertices of  $P_1$  not in  $F_1$ . Under this transformation, the polytope  $P_1$  is contained in the pyramid  $\text{conv}(\{y\} \cup F_1)$ ; see Fig. 2.5.2(d). It follows that the orthogonal projection of  $P_1$  onto  $\text{aff } F_1$  maps  $P_1 \setminus F_1$  onto  $\text{rint } F_1$ , as desired.  $\square$

*Proof via duality* Assume that  $0 \in \text{int } P$ . Let  $v_1, \dots, v_n$  be the vertices of  $P^*$  and assume that  $v_1$  is the vertex of  $P^*$  conjugate to the facet  $F$  of  $P$ .

We translate the polytope  $P^*$  so that the vertex  $v_1$  gets closer to  $0$ . Pick a point  $y \in \text{int } P^*$  so that the hyperplane through  $y$  with normal  $v_1 - y$  strictly separates  $v_1$  from the other vertices of  $P^*$ . Then, for every  $i \in [2 \dots n]$ , we have that

$$(v_1 - y) \cdot v_i < (v_1 - y) \cdot y < (v_1 - y) \cdot v_1. \tag{2.11.9.1}$$

Define the polytope  $P_1^*$  with vertices  $\mathbf{v}_1 - \mathbf{y}, \dots, \mathbf{v}_n - \mathbf{y}$ ; the polytope  $P_1^*$  is equal to  $P^* - \mathbf{y}$ . We show that like  $P^*$ ,  $P_1^*$  contains zero in its interior. Since  $\mathbf{y} \in \text{int } P^*$ , by Theorem 1.7.6 we can write it as

$$\mathbf{y} = \alpha_1 \mathbf{v}_1 + \dots + \alpha_n \mathbf{v}_n$$

for positive scalars  $\alpha_1, \dots, \alpha_n$  such that  $\sum_{i=1}^n \alpha_i = 1$ , and so

$$\mathbf{0} = \alpha_1(\mathbf{v}_1 - \mathbf{y}) + \dots + \alpha_n(\mathbf{v}_n - \mathbf{y}),$$

yielding that  $\mathbf{0} \in \text{int } P_1^*$  by Theorem 1.7.6.

Let  $P_1$  be the dual of  $P_1^*$ . Then  $P_1$  and  $P$  are combinatorially isomorphic; let  $\sigma$  be an isomorphism from  $\mathcal{L}(P)$  to  $\mathcal{L}(P_1)$ . For each  $i \in [1 \dots n]$  and each facet  $F_i$  of  $P_1$  conjugate to the vertex  $\mathbf{v}_i - \mathbf{y}$  of  $P_1^*$ , it follows that

$$\text{aff } F_i = \left\{ \mathbf{x} \in \mathbb{R}^d \mid (\mathbf{v}_i - \mathbf{y}) \cdot \mathbf{x} = 1 \right\}. \tag{2.11.9.2}$$

We show that the facet  $F_1 = \sigma(F)$  of  $P_1$  has the desired properties. Because of (2.11.9.2), for every  $\mathbf{x} \in P_1$  and every  $i \in [1 \dots n]$ , we have that  $(\mathbf{v}_i - \mathbf{y}) \cdot \mathbf{x} \leq 1$ , and for every point  $\mathbf{x} \in P_1 \setminus F_1$  we have that  $(\mathbf{v}_1 - \mathbf{y}) \cdot \mathbf{x} < 1$ . Consider a point  $\mathbf{x} \in P_1 \setminus F_1$ . Its projection  $\mathbf{x}' := \pi_{\text{aff } F_1}(\mathbf{x})$  onto  $\text{aff } F_1$  is given by (1.4.8):

$$\mathbf{x}' = \mathbf{x} - \frac{(\mathbf{v}_1 - \mathbf{y}) \cdot \mathbf{x} - 1}{\|\mathbf{v}_1 - \mathbf{y}\|^2}(\mathbf{v}_1 - \mathbf{y}).$$

The point  $\mathbf{x}'$  is in the interior of  $\bigcap_{i=2}^n H_d^-(\mathbf{v}_i - \mathbf{y}, 1)$ :

$$\begin{aligned} (\mathbf{v}_i - \mathbf{y}) \cdot \mathbf{x}' &= (\mathbf{v}_i - \mathbf{y}) \cdot \left[ \mathbf{x} - \frac{(\mathbf{v}_1 - \mathbf{y}) \cdot \mathbf{x} - 1}{\|\mathbf{v}_1 - \mathbf{y}\|^2}(\mathbf{v}_1 - \mathbf{y}) \right] \\ &= (\mathbf{v}_i - \mathbf{y}) \cdot \mathbf{x} - \frac{(\mathbf{v}_1 - \mathbf{y}) \cdot \mathbf{x} - 1}{\|\mathbf{v}_1 - \mathbf{y}\|^2}(\mathbf{v}_i - \mathbf{y}) \cdot (\mathbf{v}_1 - \mathbf{y}) \\ &\leq 1 - \frac{(\mathbf{v}_1 - \mathbf{y}) \cdot \mathbf{x} - 1}{\|\mathbf{v}_1 - \mathbf{y}\|^2}(\mathbf{v}_i - \mathbf{y}) \cdot (\mathbf{v}_1 - \mathbf{y}) \\ &< 1. \end{aligned}$$

To see the last step, observe that

$$\frac{(\mathbf{v}_1 - \mathbf{y}) \cdot \mathbf{x} - 1}{\|\mathbf{v}_1 - \mathbf{y}\|^2} < 0 \text{ and that } (\mathbf{v}_i - \mathbf{y}) \cdot (\mathbf{v}_1 - \mathbf{y}) < 0 \text{ by (2.11.9.1).}$$

As  $\mathbf{x}' \in \text{aff } F_1 \cap \text{int} \left( \bigcap_{i=2}^n H_d^-(\mathbf{v}_i - \mathbf{y}, 1) \right)$ , we conclude that  $\mathbf{x}' \in \text{rint } F_1$ , as desired. □

Thanks to Theorem 2.11.9, we can transform a polytope  $P$  with a given facet  $F$  into a combinatorially isomorphic polytope  $P'$  so that, for the facet  $F'$  of  $P'$  corresponding to  $F$ , the orthogonal projection  $\pi$  of each point  $\mathbf{x} \in P'$  onto  $F'$

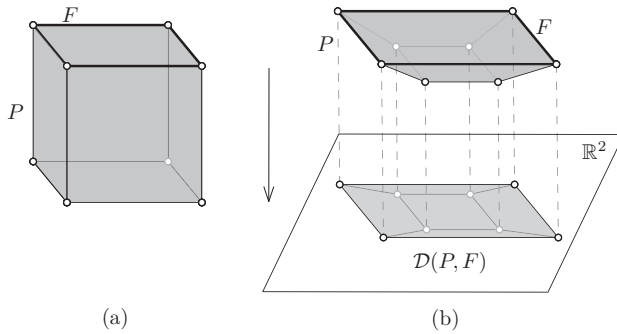

Figure 2.11.7 A Schlegel diagram of the 3-cube represented as a regular subdivision. (a) A 3-cube  $P$  with a facet  $F$  highlighted. (b) A Schlegel diagram  $\mathcal{D}(P, F)$  of 3-cube  $P$  at a facet  $F$  where  $\mathcal{D}(P, F)$  is combinatorially isomorphic to a regular subdivision of  $F$ .

lies in the relative interior of  $F'$ . As a result, the Schlegel diagram  $\mathcal{D}(P, F)$  of  $P$  at  $F$  is combinatorially isomorphic to the Schlegel diagram  $\mathcal{D}(P', F')$  of  $P'$  at  $F'$ ; see Fig. 2.11.7. This construction has an important consequence.

**Proposition 2.11.10** *Let  $P$  be a  $d$ -polytope,  $F$  a facet of it, and  $\mathcal{D}(P, F)$  a Schlegel diagram of  $P$  at  $F$ . Then  $\mathcal{D}(P, F)$  is combinatorially isomorphic to a regular subdivision of  $F$ .*

*Proof* We first preprocess  $P$  so that  $F$  is the orthogonal projection of  $P$ , as in Theorem 2.11.9; see also Proposition 2.1.3. It follows that  $\mathcal{D}(P, F)$  is the set of projections of the lower faces of  $P$ , giving that  $\mathcal{D}(P, F)$  is a regular subdivision of  $F$ . □

A Schlegel diagram of a polytope  $P$  is clearly not uniquely determined; it depends on the projection facet  $F$  and the point  $y_F$  beyond  $F$ . In view of Proposition 2.11.10 and Theorem 2.11.9, we can always assume that  $F$  is the orthogonal projection of  $P$  (see also Proposition 2.1.3).

While every Schlegel diagram can be realised as a regular subdivision (Proposition 2.11.10), not every regular subdivision is a Schlegel diagram. We use Proposition 2.11.10 to show that the regular subdivision of Fig. 2.11.3(c) is not a Schlegel diagram.

**Example 2.11.11** Suppose that the regular subdivision  $\mathcal{S}_c$  of Fig. 2.11.3(c) lies in the hyperplane  $x_3 = 0$  of  $\mathbb{R}^3$ . Further suppose that  $\mathcal{S}_c$  has vertex set  $\{v_1, \dots, v_8\}$  and lift vector  $y = (y_1, \dots, y_8)^t$  such that  $\mathcal{S}_c$  is the set of projections of the lower faces of the 3-polytope

$$P_c := \text{conv}\{(\mathbf{v}_1, y_1)^t, \dots, (\mathbf{v}_8, y_8)^t\}.$$

Suppose that  $\mathcal{S}_c$  is a Schlegel diagram of  $P_c$  at a facet  $F$  with vertex set  $(\mathbf{v}_1, y_1)^t, (\mathbf{v}_2, y_2)^t, (\mathbf{v}_3, y_3)^t, (\mathbf{v}_4, y_4)^t$ . Then  $F$  lies in a plane of  $\mathbb{R}^3$ . The analysis in Example 2.11.2(c) showed that  $y_1 > y_2, y_3 > y_2, y_3 > y_4, y_1 > y_4$ ; this contradicts the planarity of  $\text{aff } F$ . Hence,  $\mathcal{S}_c$  is not a Schlegel diagram.

### Stars, Antistars, and Links in complexes

For a polytopal complex  $\mathcal{C}$ , the *star* of a face  $F$  in  $\mathcal{C}$ , denoted  $\text{st}(F, \mathcal{C})$ , is the subcomplex of  $\mathcal{C}$  formed by all the faces containing  $F$  and their faces; the *antistar* of a face  $F$  of  $\mathcal{C}$ , denoted  $\text{ast}(F, \mathcal{C})$ , is the subcomplex of  $\mathcal{C}$  formed by all the faces disjoint from  $F$ ; and the *link* of a face  $F$ , denoted  $\text{lk}(F, \mathcal{C})$ , is the subcomplex of  $\mathcal{C}$  formed by all the faces of  $\text{st}(F, \mathcal{C})$  that are disjoint from  $F$ . For a subset  $X$  of  $\mathcal{V}(\mathcal{C})$ , we denote by  $\mathcal{C} - X$  the subcomplex of  $\mathcal{C}$  formed by the faces of  $\mathcal{C}$  that contain no vertex from  $X$ . It follows that  $\text{ast}(F, \mathcal{C}) = \mathcal{C} - \mathcal{V}(F)$  and  $\text{lk}(F, \mathcal{C}) = \text{st}(F, \mathcal{C}) - \mathcal{V}(F)$ . We define stars, antistars, and links in a polytope always with respect to  $\mathcal{B}(P)$ ; that is why we often write  $\text{st}(F, P)$ ,  $\text{ast}(F, P)$ , or  $\text{lk}(F, P)$  without explicitly stating  $\mathcal{B}(P)$ . Furthermore, we may also write  $\text{st}(F)$ ,  $\text{ast}(F)$ , or  $\text{lk}(F)$  if  $P$  is clear from the context.

Figure 2.11.8 depicts the star and link of a vertex in the 4-cube. Let  $\mathbf{x}$  be a vertex in a  $d$ -cube  $Q(d)$  and let  $\mathbf{x}^o$  denote the unique vertex not contained in the star of  $\mathbf{x}$ . Then the antistar of  $\mathbf{x}$  coincides with the star of  $\mathbf{x}^o$  and the link of  $\mathbf{x}$  is the subcomplex  $\mathcal{C}(Q(d)) - \{\mathbf{x}, \mathbf{x}^o\}$ .

The star, antistar, and link of a vertex are all pure complexes. But more is true for the link.

**Proposition 2.11.12** *Let  $P$  be a  $d$ -polytope. Then the link of a vertex in  $\mathcal{B}(P)$  is combinatorially isomorphic to the boundary complex of a  $(d - 1)$ -polytope.*

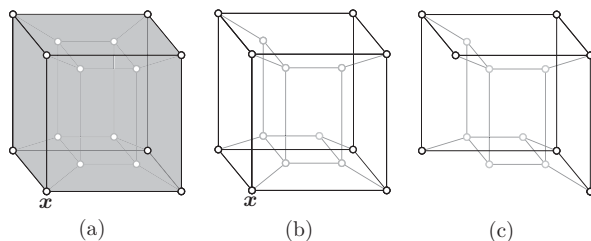

Figure 2.11.8 Complexes in the 4-cube. (a) The 4-cube with a vertex  $\mathbf{x}$  highlighted. (b) The star of the vertex  $\mathbf{x}$ . (c) The link of the vertex  $\mathbf{x}$ .

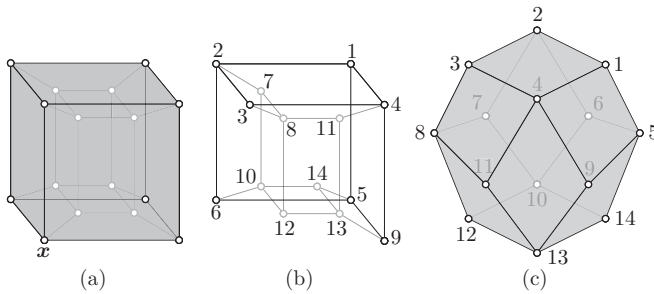

Figure 2.11.9 The link of a vertex in the 4-cube. (a) The 4-cube with a vertex  $x$  highlighted. (b) The link of the vertex  $x$  in the 4-cube. (c) The link of the vertex  $x$  as the boundary complex of the rhombic dodecahedron (Proposition 2.11.12).

*In particular, for each  $d \geq 3$ , the graph of the link of a vertex is isomorphic to the graph of a  $(d - 1)$ -polytope.*

*Proof* Let  $x$  be a vertex of  $P$  and let  $x'$  be a point in  $\mathbb{R}^d \setminus P$  beyond  $x$ . Suppose  $P' := \text{conv}(P \cup \{x'\})$ . We could think of  $P'$  as being obtained from  $P$  by pulling the vertex  $x$  to  $x'$  (Theorem 2.10.3).

The facets in the star of  $x$  in  $\mathcal{B}(P)$  are precisely those that are visible from  $x'$ , and every other facet of  $P$ , which is in the antistar of  $x$ , is nonvisible from  $x'$ . The link of  $x$  is, by definition, the subcomplex of  $\mathcal{B}(P)$  induced by the ridges of  $P$  that are contained in a facet of the star of  $x$ , a facet visible from  $x'$ , and a facet of the antistar of  $x$ , a facet nonvisible from  $x'$ . Consequently, according to Theorem 2.10.1(i) the ridges in  $\text{lk}(x, \mathcal{B}(P))$  are all faces of  $P'$ . Furthermore, for every ridge  $R \in \text{lk}(x, \mathcal{B}(P))$ ,  $R' := \text{conv}(R \cup \{x'\})$  is a facet of  $P'$  (Theorem 2.10.1(iii)), a pyramid over  $R$  with apex  $x'$ ; and every facet in the star of  $x'$  in  $\mathcal{B}(P')$  is one of these pyramids. Hence, the boundary complex of the vertex figure of  $P'$  at  $x'$  is combinatorially isomorphic to the link of  $x$  in  $P$ . Since the vertex figure is combinatorially isomorphic to a  $(d - 1)$ -polytope (Theorem 2.7.3), the proposition follows.  $\square$

Proposition 2.11.12 is exemplified in Fig. 2.11.9.

## 2.12 Shellings and Euler–Poincaré–Schläfli's Equation

A shelling is a certain linear ordering of the facets of a pure complex. While not every pure complex has a shelling, the boundary complex of every polytope has one; this is central to a number of inductive arguments on polytopes.

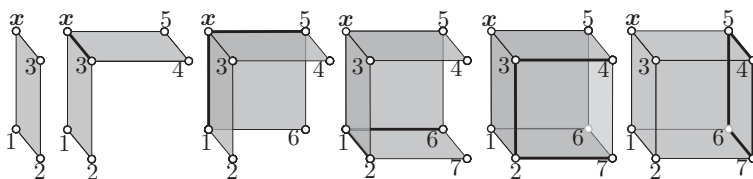

Figure 2.12.1 A shelling  $F_1 = x123, F_2 = x345, F_3 = x156, F_4 = 1267, F_5 = 2347, F_6 = 4567$  of the boundary complex of the 3-cube, where the facets of the star of a vertex  $x$  come first. The intersection of the current facet with the union of the previous ones is highlighted in bold.

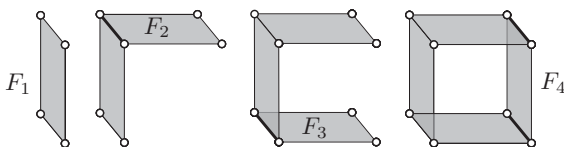

Figure 2.12.2 A sequence  $F_1, F_2, F_3, F_4$  of facets of the boundary complex of the 3-cube that is not the beginning of any shelling of the 3-cube. The intersection of the current facet with the union of the previous ones is highlighted in bold. The intersection  $F_4 \cap (F_1 \cup F_2 \cup F_3)$  is not the beginning of a shelling of  $F_4$ .

**Definition 2.12.1** (Shelling) Let  $C$  be a pure complex. A *shelling* of  $C$  is a linear ordering  $F_1, \dots, F_s$  of the facets of the complex such that either  $\dim C = 0$ , in which case the facets are vertices, or it satisfies the following:

- (i) The boundary complex of  $F_1$  has a shelling.
- (ii) For  $j \in [2 \dots s]$ , the intersection

$$F_j \cap \left( \bigcup_{i=1}^{j-1} F_i \right) = R_1 \cup \dots \cup R_r$$

is nonempty and the beginning  $R_1, \dots, R_r$  of a shelling  $R_1, \dots, R_r, R_{r+1}, \dots, R_t$  of the boundary complex of  $F_j$ .

A complex is *shellable* if it is pure and admits a shelling. Figure 2.12.1 depicts an example of a shelling, while Fig. 2.12.2 depicts a sequence of facets that is not the beginning of any shelling. Abusing terminology, we will refer to a shelling of the boundary complex of a polytope as a shelling of the polytope.

Shellings of a complex can be rearranged in number of ways.

**Lemma 2.12.2** Let  $C$  be a shellable complex and let  $F_1, \dots, F_r, J_{r+1}, \dots, J_s$  be a shelling of  $C$ . If  $F'_1, \dots, F'_r$  is a different shelling of the subcomplex  $C(F_1 \cup \dots \cup F_r)$  of  $C$  then  $F'_1, \dots, F'_r, J_{r+1}, \dots, J_s$  is a different shelling of  $C$ .

In the case of polytopes, we can even obtain a new shelling by reversing the order of a shelling.

**Lemma 2.12.3** *Let  $P$  be a  $d$ -polytope and let  $F_1, \dots, F_s$  be a shelling of  $P$ . Then the reverse sequence  $F_s, \dots, F_1$  is also shelling of  $P$ .*

*Proof* The lemma is plainly true for  $d = 1$ , and so we have the basis of an induction on  $d$ . Assume that  $d \geq 2$ . Since  $F_1, \dots, F_s$  is a shelling of  $P$  each facet  $F_i$  for  $i \in [1 \dots s]$  is shellable (Definition 2.12.1(i)–(ii)); in particular, for  $j \in [2 \dots s]$ , the intersection

$$F_j \cap \left( \bigcup_{i=1}^{j-1} F_i \right) = R_1 \cup \dots \cup R_r$$

is nonempty and can be extended to a shelling  $R_1, \dots, R_r, R_{r+1}, \dots, R_t$  of  $F_j$ . By the induction hypothesis, the sequence  $R_t, \dots, R_{r+1}, R_r, \dots, R_1$  is a shelling of  $F_j$ . For every  $(d - 2)$ -face  $R$  of  $F_j$ , there is a unique facet  $F_\ell$  such that  $R = F_\ell \cap F_j$ , and so the intersection

$$F_j \cap \left( \bigcup_{i=j+1}^s F_i \right) = R_t \cup \dots \cup R_{r+1}$$

is nonempty and the beginning of a shelling of  $F_j$ . Since  $F_s$  is shellable, we obtain the shelling  $F_s, \dots, F_1$  of  $P$ , and so the proof of the lemma is complete. □

We extend the notion of ‘general position’ given in Section 1.1 from sets in  $\mathbb{R}^d$  to points, lines, and line functionals in  $\mathbb{R}^d$ , with respect to a  $d$ -polytope.

**Definition 2.12.4** (Point in general position) Let  $P$  be a  $d$ -polytope in  $\mathbb{R}^d$  and let  $F_1, \dots, F_n$  be the facets of  $P$ . A point  $x$  is in *general position* with respect to  $P$  if it does not lie in any of the hyperplanes  $\text{aff } F_1, \dots, \text{aff } F_n$ .

**Definition 2.12.5** (Line in general position) Let  $P$  be a  $d$ -polytope in  $\mathbb{R}^d$  and let  $F_1, \dots, F_n$  be the facets of  $P$ . A line  $\ell$  is in *general position* with respect to  $P$  if it is not parallel to any of the hyperplanes  $\text{aff } F_i$  and intersects the hyperplanes  $\text{aff } F_i$  at pairwise distinct points.

**Definition 2.12.6** (Linear functional in general position) Let  $P$  be a  $d$ -polytope in  $\mathbb{R}^d$ . A linear functional in  $\mathbb{R}^d$  is in *general position* with respect to  $P$  if its values on the vertices of  $P$  are pairwise distinct.

We establish the existence of lines and linear functionals in general position with respect to a polytope. The proofs rely on the fact that finitely many polynomials in one variable have together only finitely many zeros.

**Proposition 2.12.7**<sup>8</sup> *Let  $P$  be a  $d$ -polytope in  $\mathbb{R}^d$ . Then, every nonzero vector  $\mathbf{a}$  in  $\mathbb{R}^d$  can be perturbed slightly so that the resulting vector  $\mathbf{a}(\varepsilon)$  for some  $\varepsilon > 0$  defines a line  $\ell(\varepsilon) := \alpha\mathbf{a}(\varepsilon)$  or a linear functional  $\varphi_\varepsilon(\mathbf{x}) := \mathbf{a}(\varepsilon) \cdot \mathbf{x}$  that is in general position with respect to  $P$ .*

Shellings in polytopes have many theoretical and computational applications. We show their existence next.

**Theorem 2.12.8** (Existence of line shellings; Bruggesser and Mani, 1971) *Every polytope is shellable.*

*Proof* Let  $P$  be a  $d$ -polytope in  $\mathbb{R}^d$  with  $\mathbf{0}$  in its interior. We prove the existence of a particular kind of shelling of  $P$ .

*Let  $\mathbf{x} \in \mathbb{R}^d \setminus P$  be a point in general position with respect to  $P$ . Then there is a shelling of  $P$  in which the facets of  $P$  that are visible from  $\mathbf{x}$  come first and the facets that are nonvisible from  $\mathbf{x}$  come last.* (\*)

The statement (\*) is true for  $d = 1$ , and so assume that  $d \geq 2$ . As part of an induction argument on  $d$ , suppose that (\*) holds for  $d - 1$ .

Take a line  $\ell$  that hits the interior of  $P$ , passes through  $\mathbf{0}$  and  $\mathbf{x}$  (that is,  $\ell = \alpha\mathbf{x}$  for every  $\alpha \in \mathbb{R}$ ), and is in general position with respect to  $P$ . Orient  $\ell$  from the interior of  $P$  to  $\mathbf{x}$ ; see Fig. 2.12.3. While traversing  $\ell$ , if you reach infinity then return to the polytope from the opposite side. Label the facets  $F_1, \dots, F_n$  of  $P$  as they become visible when traversing  $\ell$ , and let  $\mathbf{x}_i$  be the intersection of  $\ell$  with  $\text{aff } F_i$  for each  $i \in [1 \dots n]$ . By our choice of  $\ell$ , the points  $\mathbf{x}_1, \dots, \mathbf{x}_n$  are all distinct. Further assume that when we traverse the line  $\ell = \alpha\mathbf{x}$  from  $\mathbf{0}$  to  $\mathbf{x}$ , we encounter the points  $\mathbf{x}_1, \dots, \mathbf{x}_k$ , in that order before reaching infinity, and then encounter the points  $\mathbf{x}_{k+1}, \dots, \mathbf{x}_n$ , again in that order, when we return to the polytope from the opposite side.

For each  $i \in [1 \dots n]$ , suppose that

$$\text{aff } F_i = \left\{ \mathbf{y} \in \mathbb{R}^d \mid \mathbf{a}_i \cdot \mathbf{y} = 1 \right\},$$

in which case each inequality  $\mathbf{a}_i \cdot \mathbf{y} \leq 1$  is valid for  $P$ . This implies that

$$\mathbf{x}_i = \frac{\mathbf{x}}{\mathbf{x} \cdot \mathbf{a}_i} \tag{2.12.8.1}$$

<sup>8</sup> A proof is available in Ziegler (1995, lem. 3.2).



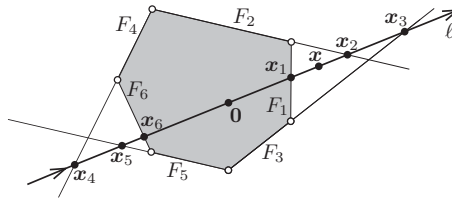

Figure 2.12.3 A line shelling  $F_1, \dots, F_6$  of the boundary complex of a polytope. The line  $\ell$  is oriented from the interior of the polytope to a point  $x$  and, for each  $i \in [1 \dots 6]$ , the point  $x_i$  is the intersection of  $\ell$  with  $\text{aff } F_i$ .

and that

$$x \cdot a_1 > x \cdot a_2 > \dots > x \cdot a_k > 0 > x \cdot a_{k+1} > \dots > x \cdot a_n, \quad (2.12.8.2)$$

which in turn yields that

$$\frac{1}{x \cdot a_{k+1}} < \dots < \frac{1}{x \cdot a_n} < 0 < \frac{1}{x \cdot a_1} < \frac{1}{x \cdot a_2} < \dots < \frac{1}{x \cdot a_k}. \quad (2.12.8.3)$$

By construction, the sequence  $F_1, \dots, F_n$  is ordered so that the facets visible from  $x$  come before the facets that are nonvisible from  $x$ . See Fig. 2.12.3.

It remains to show that the sequence  $F_1, \dots, F_n$  is a shelling of  $P$ . We verify Definition 2.12.1. The facet  $F_1$  is shellable by induction. Each point  $x_j$  with  $j \in [2 \dots n]$  is outside  $F_j$  and is in general position with respect to  $F_j$ . Suppose the facet  $F_j$  appears before reaching infinity. The intersection

$$F_j \cap \left( \bigcup_{i=1}^{j-1} F_i \right)$$

is precisely the union of the facets  $R_1, \dots, R_r$  of  $F_j$  that are visible from  $x_j$ :  $a_j \cdot x_j = 1$  and  $a_i \cdot x_j > 1$  for each  $i \in [1 \dots j-1]$ , by (2.12.8.1) and (2.12.8.2). Therefore, the induction hypothesis ensures that  $R_1, \dots, R_r$  is the beginning of a shelling of  $F_j$ , which also implies that the other facets of  $F_j$ , those nonvisible from  $x_j$ , are the end of the shelling. Thus, Definition 2.12.1(ii) holds for this facet  $F_j$ . Further, suppose that the facet  $F_j$  appears after we passed infinity. The intersection

$$F_j \cap \left( \bigcup_{i=1}^{j-1} F_i \right)$$

consists precisely of the facets  $R_1, \dots, R_r$  of  $F_j$  that are nonvisible from  $x_j$ :  $a_j \cdot x_j = 1$  and  $a_i \cdot x_j < 1$  for each  $i \in [1 \dots j-1]$ , by (2.12.8.1) and (2.12.8.2). Therefore the induction hypothesis ensures that  $R_1, \dots, R_r$  are the

end of a shelling  $S$  of  $F_j$ . According to Lemma 2.12.3, the faces  $R_1, \dots, R_r$  is the beginning of another shelling of  $F_j$ , the shelling obtained by reversing  $S$ . Thus, Definition 2.12.1(ii) holds for this facet  $F_j$  as well. Consequently, the two conditions of Definition 2.12.1 are met and so the order  $F_1, \dots, F_n$  is a shelling of  $P$ . This completes the proof of (\*), and with it, the proof of the theorem.  $\square$

**Remark 2.12.9** In the proof of Theorem 2.12.8, the point  $x$  in (\*) need not be in general position with respect to  $P$ . For the proof of Theorem 2.12.8 to work, what matters is that the line  $\ell = \alpha x$  intersects the interior of  $P$  and is in general position with respect to  $P$  (Definition 2.12.5), namely the points  $x_1, \dots, x_n$  are all distinct. If  $x$  is in general condition with respect to  $P$ , these two conditions on  $\ell$  are satisfied.

Line shellings provide a mechanism to shell a polytope in a number of ways.

**Proposition 2.12.10** *A polytope  $P$  admits a shelling with any of the following prescribed conditions:*

- (i) *any two facets  $F$  and  $F'$  of  $P$  can be chosen so that  $F$  is the first facet and  $F'$  is the last facet of the shelling;*
- (ii) *for every vertex  $z$  of  $P$ , the star of  $z$  is the beginning of the shelling.*

*Proof* The two proofs are very similar; they both rely on using two points to define the line that induces the shelling.

(i) Choose a point  $y_F$  beyond the facet  $F$  and a point  $y_{F'}$  beyond the facet  $F'$ , and let  $\ell$  be the line determined by  $y_F$  and  $y_{F'}$  so that  $\ell$  hits the interior of  $P$  and is in general position with respect to  $P$ . It follows that the points  $y_F$  and  $y_{F'}$  are in general position with respect to  $P$ . The selection of  $y_F$ ,  $y_{F'}$ , and  $\ell$  can be done in two steps. First, place  $y_F$  on the relative interior of  $F$  and  $y_{F'}$  on the relative interior of  $F'$  so that if they move along  $\ell$  then they land outside  $P$  with  $y_F$  beyond the facet  $F$  and  $y_{F'}$  beyond the facet  $F'$ ; this guarantees that the line  $\ell$  hits the interior of  $P$ . Second, slightly perturb  $\ell$  so that it becomes in general position with respect to  $P$  (Proposition 2.12.7).

Traversing the line  $\ell$  from  $y_{F'}$  to  $y_F$  gives the desired line shelling (Theorem 2.12.8): the facet  $F$  will be the first facet visible from  $y_F$ , while if we traverse the line ‘backwards’, in the reverse direction, the facet  $F'$  will be the first to be visible from  $y_{F'}$ .

(ii) Choose a point  $x$  beyond the vertex  $z$  and a line  $\ell$  that passes through  $x$  and the interior of  $P$ . The point  $x$  is in general position with respect to  $P$ . If necessary, perturb  $\ell$  so that it is in general position with respect to  $P$  (Proposition 2.12.7). Traversing the line  $\ell$  from the interior of  $P$  to  $x$  gives a

line shelling where the facets in the star of  $z$ , all visible from  $x$ , are the first facets encountered by the line  $\ell$  (Theorem 2.12.8). □

The link of a vertex in a polytope is combinatorially isomorphic to the boundary complex of a  $(d - 1)$ -polytope (Proposition 2.11.12), and so it is shellable by Theorem 2.12.8.

**Proposition 2.12.11** *Let  $P$  be a polytope and let  $x$  be a vertex of  $P$ . Then the link of  $x$  in  $P$  is shellable.*

Shellings of a polytopal complex induce shellings of the star of a vertex.

**Proposition 2.12.12** *Let  $C$  be a shellable  $(d - 1)$ -complex and let  $x$  be a vertex of  $C$ . Then the star of  $x$  in  $C$  is shellable. Moreover, the restriction of every shelling of  $C$  to the facets in the star of  $x$  is a shelling of the star of  $x$ .*

*Proof* The proposition is true for  $d = 1$ , since the star of  $x$  is 0-dimensional and thus shellable by Definition 2.12.1. Assume  $d \geq 2$ . The proof proceeds by induction on  $d$ . Let  $F_1, \dots, F_n$  be a shelling  $S$  of  $C$ , and let  $F_{i_1}, \dots, F_{i_t}$  be the restriction of  $S$  to  $\text{st}(x, C)$ . Each facet in  $S$  is a  $(d - 1)$ -polytope and, thus, it is shellable by Theorem 2.12.8; in particular,  $F_{i_1}$  is shellable. In view of Definition 2.12.1, it remains to show that, for each  $p \in [2 \dots t]$ ,

$$F_{i_p} \cap (F_{i_1} \cup \dots \cup F_{i_{p-1}}) \tag{2.12.12.1}$$

is the beginning of a shelling  $S_{i_p}$  of  $F_{i_p}$ . Observe that (2.12.12.1) is a subset of  $\text{st}(x, F_{i_p})$ .

Because  $F_1, \dots, F_n$  is a shelling of  $P$ , there is a sequence  $R_1, \dots, R_r$  of  $(d - 2)$ -faces of  $F_{i_p}$  such that

$$F_{i_p} \cap (F_1 \cup F_2 \cup \dots \cup F_{i_{p-1}}) = R_1 \cup \dots \cup R_r \tag{2.12.12.2}$$

is nonempty and can be extended to a shelling  $S'_{i_p} := R_1, \dots, R_r, R_{r+1}, \dots, R_s$  of  $F_{i_p}$ . It follows that

$$\{F_{i_1}, \dots, F_{i_{p-1}}\} \subseteq \{F_1, F_2, \dots, F_{i_{p-1}}\}.$$

The shelling  $S'_{i_p}$  is that of a shellable  $(d - 2)$ -complex. Hence, the induction hypothesis on  $\mathcal{B}(F_{i_p})$  and  $S'_{i_p}$  implies that the restriction  $R_{j_1}, \dots, R_{j_q}$  of  $S'_{i_p}$  to the  $(d - 2)$ -faces in the star of  $x$  in  $F_{i_p}$  is a shelling of  $\text{st}(x, F_{i_p})$ . Let  $\ell$  be the largest integer in  $[1 \dots q]$  such that  $j_\ell \leq r$ ; see (2.12.12.2). Then  $R_{j_1}, \dots, R_{j_q}$  is a shelling of  $\text{st}(x, F_{i_p})$  that begins with the sequence  $R_{j_1}, \dots, R_{j_\ell}$ :

$$\text{st}(x, F_{i_p}) = R_{j_1} \cup \dots \cup R_{j_\ell} \cup R_{j_{\ell+1}} \cup \dots \cup R_{j_q}. \tag{2.12.12.3}$$

Furthermore, the  $(d - 2)$ -faces  $R_{j_1}, \dots, R_{j_\ell}$  are precisely the  $(d - 2)$ -faces of  $F_{i_p}$  in (2.12.12.1):

$$F_{i_p} \cap (F_{i_1} \cup \dots \cup F_{i_{p-1}}) = R_{j_1} \cup \dots \cup R_{j_\ell}. \tag{2.12.12.4}$$

Finally, there is a shelling  $S''_{i_p}$  of  $F_{i_p}$  that begins with the  $(d - 2)$ -faces of  $\text{st}(\mathbf{x}, F_{i_p})$  by Proposition 2.12.10(ii); that is,  $S''_{i_p}$  can be written as

$$S''_{i_p} = \underbrace{R_{k_1}, \dots, R_{k_q}}_{\text{st}(\mathbf{x}, F_{i_p})}, R_{k_{q+1}}, \dots, R_{k_s},$$

where  $R_{k_1}, \dots, R_{k_q}$  are the  $(d - 2)$ -faces of  $\text{st}(\mathbf{x}, F_{i_p})$ . As a consequence of Lemma 2.12.2 and of  $R_{j_1}, \dots, R_{j_q}$  being a shelling of  $\text{st}(\mathbf{x}, F_{i_p})$ , the shelling  $S''_{i_p}$  can be rearranged to obtain the desired shelling  $S_{i_p}$  of  $F_{i_p}$ , which begins with the shelling of  $\text{st}(\mathbf{x}, F_{i_p})$  in (2.12.12.3). That is,

$$S_{i_p} = \underbrace{R_{j_1}, \dots, R_{j_\ell}, R_{j_{\ell+1}}, \dots, R_{j_q}}_{\text{st}(\mathbf{x}, F_{i_p})}, R_{k_{q+1}}, \dots, R_{k_s}.$$

This establishes that (2.12.12.1) is the beginning of the shelling  $S_{i_p}$  of  $F_{i_p}$ ; see also (2.12.12.4). This proves the statement of the proposition.  $\square$

With the help of Lemma 2.12.2 and Proposition 2.12.12, more involved shellings of a polytope can be produced.

**Proposition 2.12.13** *Let  $P$  be a polytope,  $\mathbf{x}$  a vertex of  $P$ , and  $F$  a facet that is not in the star of  $\mathbf{x}$  in  $P$ . Then there is a shelling of  $P$  where the facets in the star of  $\mathbf{x}$  come first and the facet  $F$  comes last. Furthermore, any two facets  $F'$  and  $F''$  in the star of  $\mathbf{x}$  can be taken as the first and last facets of the shelling of the star of  $\mathbf{x}$ .*

*Proof* The proof is similar to that of Proposition 2.12.10. Choose a point  $\mathbf{y}_x$  beyond the vertex  $\mathbf{x}$  and a point  $\mathbf{y}_F$  beyond the facet  $F$ , and let  $\ell$  be the line determined by  $\mathbf{y}_x$  and  $\mathbf{y}_F$ . Again, if necessary, perturb  $\ell$  so that it becomes in general position with respect to  $P$ . Traversing the line  $\ell$  from  $\mathbf{y}_F$  to  $\mathbf{y}_x$  gives a line shelling  $S$  where the facets in the star of  $\mathbf{x}$  come first, inducing a line shelling  $S_i$  of  $\text{st}(\mathbf{x}, P)$ , and the facet  $F$  come last. Let  $S_f$  be the sequence of facets in  $S$  that follows  $S_i$ ; that is,  $S = S_i S_f$ .

We now use Lemma 2.12.2 to modify the shelling  $S$ ; we provide a different shelling  $S'_i$  of the star of  $\mathbf{x}$  that begins with the facet  $F'$  and ends with the facet  $F''$ . This new shelling  $S'_i$  exists for the following reasons: (1) by Proposition 2.12.10(i) there exists a shelling of  $P$  that begins with the facet  $F'$  and ends with the facet  $F''$ , and (2) the restriction of this shelling of  $P$  to the

star of  $x$  is a shelling of  $\text{st}(x, P)$  that begins with the facet  $F'$  and ends with the facet  $F''$  (Proposition 2.12.12); we let  $S'_i$  be this shelling of  $\text{st}(x, P)$ . The shelling  $S'_i S_f$  is the desired shelling of  $P$ . □

The same approach in the proof of Proposition 2.12.13 gives the following.

**Proposition 2.12.14** *Let  $P$  be a polytope,  $x$  a vertex of  $P$ , and  $F$  a facet in the star of  $x$  in  $P$ . Then there is a shelling of  $P$  where the facets in the star of  $x$  come last and the facet  $F$  is the last facet of the shelling.*

### Euler–Poincaré–Schläfli’s Equation

The polyhedral equation of Euler (1758b) is one of the earliest contributions to polytope theory. The equation relates the number of vertices, edges, and faces of a 3-polytope. According to Francese and Richeson (2007), Euler’s original proof had mistakes. Schläfli (1850–52) generalised the equation to all dimensions, but his proof relied on the existence of shellings in polytopes, which was assumed but not proved at the time. As we know, the existence of shellings of polytopes was established much later by Bruggesser and Mani (1971). Poincaré (1893) attempted another proof of Schläfli’s generalisation, but his proof was also erroneous, as claimed by Gruber (2007, sec. 15.2). Hence, it is fitting to call the generalisation of Euler’s equation to all dimensions ‘Euler–Poincaré–Schläfli’s equation’.

For a complex  $\mathcal{C}$  of dimension  $d - 1$ , let  $f_i := f_i(\mathcal{C})$  and define the *Euler characteristic*  $\chi$  as

$$\chi(\mathcal{C}) := f_0 - f_1 + \cdots + (-1)^{d-1} f_{d-1}. \tag{2.12.15}$$

The Euler characteristic of the union  $\mathcal{C} \cup \mathcal{C}'$  of complexes  $\mathcal{C}$  and  $\mathcal{C}'$ , in case it is a complex, satisfies an attractive additivity property (can you prove it?).

**Lemma 2.12.16** *Let  $\mathcal{C}$  and  $\mathcal{C}'$  be polytonal complexes such that  $\mathcal{C} \cup \mathcal{C}'$  is a complex too. Then*

$$\chi(\mathcal{C} \cup \mathcal{C}') = \chi(\mathcal{C}) + \chi(\mathcal{C}') - \chi(\mathcal{C} \cap \mathcal{C}').$$

**Theorem 2.12.17** (Euler–Poincaré–Schläfli’s equation) *Let  $P$  be a  $d$ -polytope. Then*

$$\begin{aligned} \chi(\mathcal{B}(P)) &= f_0 - f_1 + \cdots + (-1)^{d-1} f_{d-1} = 1 - (-1)^d, \\ \chi(\mathcal{C}(P)) &= \chi(\mathcal{B}(P)) + (-1)^d = 1. \end{aligned}$$

*Proof* Let  $S := F_1, \dots, F_s$  be a shelling of  $P$  and let

$$\mathcal{C}_j := \mathcal{C}(F_1 \cup \dots \cup F_j), \text{ for each } j \in [1 \dots s].$$

We show that

$$\chi(\mathcal{C}_j) = \begin{cases} 1, & \text{for } j \in [1 \dots s - 1]; \\ 1 - (-1)^d, & \text{for } j = s. \end{cases} \tag{2.12.17.1}$$

The veracity of (2.12.17.1) implies the theorem, as  $\chi(\mathcal{C}(P)) = \chi(\mathcal{B}(P)) + (-1)^d = 1$  by (2.12.15), and  $\mathcal{C}_s = \mathcal{B}(P)$ . We prove (2.12.17.1) by induction on  $d$  for every  $j$ .

It is clear that (2.12.17.1) is true for  $d = 1$  and every  $j \in [1 \dots s]$ . And so we assume that  $d \geq 2$  and that (2.12.17.1) is true for every shelling of a polytope of dimension less than  $d$  and at every step of the shelling.

For each  $j \in [1 \dots s]$ , (2.12.15) gives that

$$\chi(\mathcal{C}(F_j)) = \chi(\mathcal{B}(F_j)) + (-1)^{d-1},$$

and the induction hypothesis on  $d - 1$  gives that

$$\chi(\mathcal{B}(F_j)) = 1 - (-1)^{d-1} \text{ and } \chi(\mathcal{C}(F_j)) = 1. \tag{2.12.17.2}$$

In particular, (2.12.17.1) holds for  $d$  and  $j = 1$ , as

$$\chi(\mathcal{C}_1) = \chi(\mathcal{C}(F_1)) = 1.$$

Consider  $j \in [1 \dots s]$ . Since  $\mathcal{C}_j = \mathcal{C}_{j-1} \cup \mathcal{C}(F_j)$  and  $\mathcal{C}_{j-1} \cap \mathcal{C}(F_j) = \mathcal{C}(F_j \cap (F_1 \cup \dots \cup F_{j-1}))$ , Lemma 2.12.16 together with (2.12.17.2) yields the equality

$$\begin{aligned} \chi(\mathcal{C}_j) &= \chi(\mathcal{C}_{j-1} \cup \mathcal{C}(F_j)) = \chi(\mathcal{C}_{j-1}) + \chi(\mathcal{C}(F_j)) - \chi(\mathcal{C}_{j-1} \cap \mathcal{C}(F_j)) \\ &= \chi(\mathcal{C}_{j-1}) + 1 - \chi(\mathcal{C}(F_j \cap (F_1 \cup \dots \cup F_{j-1}))). \end{aligned} \tag{2.12.17.3}$$

Because  $S$  is a shelling of  $P$ , the intersection

$$F_j \cap (F_1 \cup \dots \cup F_{j-1}) = R_1 \cup \dots \cup R_r$$

is the beginning of a shelling  $R_1, \dots, R_r, R_{r+1}, \dots, R_t$  of  $F_j$ . As a result, we rewrite (2.12.17.3) as

$$\chi(\mathcal{C}_j) = \chi(\mathcal{C}_{j-1}) + 1 - \chi(\mathcal{C}(R_1 \cup \dots \cup R_r)). \tag{2.12.17.4}$$

From the induction hypothesis on  $d - 1$ , for every  $r \in [1 \dots t]$  it follows that

$$\chi(\mathcal{C}(R_1 \cup \dots \cup R_r)) = \begin{cases} 1, & \text{for } r \in [1 \dots t - 1]; \\ 1 - (-1)^{d-1}, & \text{for } r = t. \end{cases} \tag{2.12.17.5}$$

If  $j < s$ , then  $r < t$  in (2.12.17.5). And as a consequence of (2.12.17.5), for each  $j \in [1 \dots s - 1]$  (2.12.17.4) becomes

$$\chi(\mathcal{C}_j) = \chi(\mathcal{C}_{j-1}) + 1 - 1 = \chi(\mathcal{C}_{j-1});$$

that is, for every  $j \in [1 \dots s - 1]$ , because  $\chi(\mathcal{C}_1) = 1$  we get that

$$\chi(\mathcal{C}_{s-1}) = \dots = \chi(\mathcal{C}_1) = 1. \tag{2.12.17.6}$$

If instead  $j = s$ , then  $r = t$  in (2.12.17.5), in which case,  $\mathcal{C}(R_1 \cup \dots \cup R_r) = \mathcal{B}(F_s)$ . As a result of (2.12.17.2) and (2.12.17.5), Equation (2.12.17.4) becomes

$$\chi(\mathcal{C}_s) = \chi(\mathcal{C}_{s-1}) + 1 - (1 - (-1)^{d-1}) = 1 + 1 - (1 - (-1)^{d-1}) = 1 - (-1)^d. \tag{2.12.17.7}$$

The induction is now complete, as (2.12.17.1) now follows from (2.12.17.6) and (2.12.17.7). Accordingly, the proof of the theorem is also complete.  $\square$

The case  $d = 3$  of Euler–Poincaré–Schläfli’s equation (2.12.17) is the famous relation of Euler (1758b,a).

Euler–Poincaré–Schläfli’s equation (Theorem 2.12.17) is the unique linear equation satisfied by the  $f$ -vector of all  $d$ -polytopes. The precise meaning of this assertion ensues.

**Theorem 2.12.18**<sup>9</sup> *Let  $d$  be a positive integer, and let  $\alpha_0 \in \mathbb{R}, \dots, \alpha_d \in \mathbb{R}$ . If every  $d$ -polytope  $P$  satisfies the equation*

$$\alpha_0 f_0(P) + \dots + \alpha_{d-1} f_{d-1}(P) = \alpha_d,$$

*then  $\alpha_1 = \alpha_0(-1)$ ,  $\alpha_2 = \alpha_0(-1)^2, \dots, \alpha_{d-1} = \alpha_0(-1)^{d-1}$ , and  $\alpha_d = (1 - (-1)^d)\alpha_0$ .*

If we consider the  $f$ -vector  $(f_0, \dots, f_{d-1})$  of a  $d$ -polytope  $P$  as a point in  $\mathbb{R}^d$ , Theorem 2.12.18 implies that the  $f$ -vectors of all  $d$ -polytopes lie in the hyperplane

$$\left\{ \left( \begin{matrix} x_1 \\ \vdots \\ x_d \end{matrix} \right) \in \mathbb{R}^d \mid \alpha_0 \left( \begin{matrix} 1 \\ -1 \\ \vdots \\ (-1)^{d-1} \end{matrix} \right) \cdot \left( \begin{matrix} x_1 \\ \vdots \\ x_d \end{matrix} \right) = \alpha_0 (1 - (-1)^d) \right\}$$

of  $\mathbb{R}^d$ , the so-called *Euler hyperplane*, and on no affine subspace of smaller dimension. The Euler hyperplane is affinely spanned by the  $f$ -vectors of the

<sup>9</sup> A proof is available in Webster (1994, thm. 3.5.3).

$d$ -simplex and  $d - 1$   $d$ -polytopes with  $d + 2$  vertices. For each  $r \in [0 \dots d - 2]$ , consider the simplicial  $(d - r)$ -polytope  $F_r := T(1) \oplus T(d - r - 1)$ , the direct sum of the simplices  $T(1)$  and  $T(d - r - 1)$  (see (2.6.17)). Then consider the  $r$ -fold pyramids  $\text{pyr}_r(F_r)$ , for  $r \in [0 \dots d - 2]$ . It follows that the  $f$ -vectors of the  $d$ -polytopes  $T(d)$  and  $\text{pyr}_r(F_r)$  (for  $r \in [0 \dots d - 2]$ ) form an affinely independent set in  $\mathbb{R}^d$  (Problem 2.15.13).

### 2.13 Dehn–Sommerville’s Equations

Euler–Poincaré–Schläfli’s equation (Theorem 2.12.17) is the unique linear equation satisfied by the  $f$ -vectors of all  $d$ -polytopes (Theorem 2.12.18), but there are other linear equations satisfied by the  $f$ -vector of all polytopes from a certain class. This is the case of Dehn–Sommerville’s (classical) equations (2.13.3), which are satisfied by the  $f$ -vector of all simplicial  $d$ -polytopes. Dehn–Sommerville’s equations (Theorem 2.13.3) were first established for dimension five by Dehn (1905), and later extended to all dimensions by Sommerville (1927). As is often the case, the equations were independently rediscovered by Klee (1964). For more information on the history of the equations, consult Grünbaum (2003, sec. 9.8).

Our proof of Dehn–Sommerville’s equations relies on a generalisation of Euler–Poincaré–Schläfli’s equation. We denote by  $\mathcal{F}_i(F, P)$  the set of  $i$ -faces in a  $d$ -polytope  $P$  containing a  $k$ -face  $F$ , for  $k \in [1 \dots d]$  and  $i \in [k \dots d]$ . And we let  $f_i(F, P) := \#\mathcal{F}_i(F, P)$ .

**Theorem 2.13.1** *Let  $P$  be a  $d$ -polytope in  $\mathbb{R}^d$  and let  $F$  be a proper  $k$ -face of it. Then*

$$f_k(F, P) - f_{k+1}(F, P) + \dots + (-1)^{d-k} f_d(F, P) = 0.$$

**Remark 2.13.2** Euler–Poincaré–Schläfli’s equation (Theorem 2.13.3) corresponds to the case  $F = \emptyset$  of Theorem 2.13.1.

*Proof* Without loss of generality, suppose that  $P$  is a  $d$ -polytope in  $\mathbb{R}^d$  that contains the origin in its interior, and let  $\psi$  be an antiisomorphism from  $\mathcal{L}(P)$  to  $\mathcal{L}(P^*)$ . If we apply Euler–Poincaré–Schläfli’s equation to the  $(d - 1 - k)$ -polytope  $\psi(F)$  (Theorem 2.4.12), we get that

$$f_{-1}(\psi(F)) - f_0(\psi(F)) + \dots + (-1)^{d-1-k} f_{d-2-k}(\psi(F)) + (-1)^{d-k} f_{d-1-k}(\psi(F)) = 0. \quad (2.13.2.1)$$



The number  $f_{d-1-i}(\psi(F))$  of  $(d - 1 - i)$ -faces of  $\psi(F)$  coincides with the number  $f_i(F, P)$  of  $i$ -faces in  $P$  containing  $F$ , which is a consequence of Theorem 2.4.10 and Theorem 2.4.12. Thus (2.13.2.1) is equivalent to

$$f_d(F, P) - f_{d-1}(F, P) + \dots + (-1)^{d-1-k} f_{k+1}(F, P) + (-1)^{d-k} f_k(F, P) = 0.$$

This proves the the theorem. □

**Theorem 2.13.3** (Dehn–Sommerville’s equations for simplicial polytopes)  
*The  $f$ -vector of a simplicial  $d$ -polytope satisfies the expression*

$$\sum_{i=k}^{d-1} (-1)^i \binom{i+1}{k+1} f_i = (-1)^{d-1} f_k,$$

for  $k = -1, \dots, d - 2$ .

**Remark 2.13.4** Euler–Poincaré–Schläfli’s equation (Theorem 2.13.3) corresponds to the case  $k = -1$  of the Dehn–Sommerville equations.

*Proof* For a  $k$ -face  $F$  of a simplicial  $d$ -polytope  $P$ , with  $k \in [-1 \dots d - 2]$ , Theorem 2.13.1 yields that

$$f_k(F, P) - f_{k+1}(F, P) + \dots + (-1)^{d-k} f_d(F, P) = 0, \tag{2.13.4.1}$$

which results in

$$(-1)^k f_k(F, P) + (-1)^{k+1} f_{k+1}(F, P) + \dots + (-1)^d f_d(F, P) = 0 \tag{2.13.4.2}$$

if we multiply (2.13.4.1) by  $(-1)^k$ . We run (2.13.4.2) over the set  $\mathcal{F}_k(P)$  of  $k$ -faces in the polytope  $P$ , obtaining

$$\sum_{F \in \mathcal{F}_k(P)} (-1)^k f_k(F, P) + \dots + (-1)^d f_d(F, P) = 0,$$

which is equivalent to

$$\sum_{i=k}^d (-1)^i \sum_{F \in \mathcal{F}_k(P)} f_i(F, P) = 0. \tag{2.13.4.3}$$

For each  $k \in [-1 \dots d - 2]$  and each  $i \in [k \dots d]$ , the sum  $\sum_{F \in \mathcal{F}_k(P)} f_i(F, P)$  counts the total number of inclusions between the  $k$ -faces and  $i$ -faces in  $P$ : a  $k$ -face  $F$  of  $P$  is contained in  $f_i(F, P)$   $i$ -faces of  $P$ , and we do this count for each  $k$ -face of  $P$ . Another way of counting these inclusions is to consider the  $i$ -faces. There are  $f_i(P)$   $i$ -faces in  $P$ , and an  $i$ -face  $J$  of  $P$  contains  $\binom{i+1}{k+1}$   $k$ -faces if  $i \in [k \dots d - 1]$  (as  $J$  is a simplex) and

$f_k(P)$   $k$ -faces if  $i = d$ . For each  $k \in [-1 \dots d - 2]$  and each  $i \in [k \dots d]$ , this analysis gives that

$$0 = \sum_{i=k}^d (-1)^i \sum_{F \in \mathcal{F}_k(P)} f_i(F, P) = \sum_{i=k}^{d-1} (-1)^i \binom{i+1}{k+1} f_i(P) + (-1)^d f_k(P).$$

The last equality is Dehn–Sommerville’s desired equation for  $k \in [-1 \dots d - 2]$ . □

Some of Dehn–Sommerville’s  $d$  equations of a simplicial  $d$ -polytope  $P$  are redundant. Consider the case  $d = 3$ :

$$\begin{aligned} k = -1 : & -f_{-1}(P) + f_0(P) - f_1(P) + f_2(P) = f_{-1}(P), \\ k = 0 : & f_0(P) - 2f_1(P) + 3f_2(P) = f_0(P), \\ k = 1 : & -f_1(P) + 3f_2(P) = f_1(P). \end{aligned} \tag{2.13.5}$$

The equations  $k = 0$  and  $k = 1$  are identical, and so the equation  $k = 1$  is redundant. Furthermore, the equations  $k = -1$  and  $k = 0$  are irredundant. In other words, the three equations are equivalent to the the first two. Now consider the case  $d = 4$ :

$$\begin{aligned} k = -1 : & -f_{-1}(P) + f_0(P) - f_1(P) + f_2(P) - f_3(P) = -f_{-1}(P), \\ k = 0 : & f_0(P) - 2f_1(P) + 3f_2(P) - 4f_3 = -f_0(P), \\ k = 1 : & -f_1(P) + 3f_2(P) - 6f_3(P) = -f_1(P), \\ k = 2 : & f_2(P) - 4f_3(P) = -f_2(P). \end{aligned} \tag{2.13.6}$$

The equations  $k = 1$  and  $k = 2$  are identical, and the equations  $k = -1$  and  $k = 1$  imply the equation  $k = 0$ . In other words, the four equations are equivalent to the equations  $k = -1$  and  $k = 1$ . This redundancy manifests in all dimensions.

**Theorem 2.13.7**<sup>10</sup> *For every  $d \geq 1$ , precisely  $\lfloor (d + 1)/2 \rfloor$  of Dehn–Sommerville’s  $d$  equations are irredundant.*

A consequence of Theorem 2.13.7 is the existence of  $\lfloor d/2 \rfloor + 1$  simplicial  $d$ -polytopes whose  $f$ -vectors form an affinely independent set in  $\mathbb{R}^d$  (Problem 2.15.14). Another consequence ensues.

**Corollary 2.13.8** *If we consider the  $f$ -vectors of simplicial  $d$ -polytopes as points in  $\mathbb{R}^d$ , then they lie in an affine subspace in  $\mathbb{R}^d$  of dimension  $\lfloor d/2 \rfloor$ , and on no affine subspace of smaller dimension.*

<sup>10</sup> A proof is available in Grünbaum (2003, p. 147).

### ***h*-vectors of Simplicial Polytopes**

Consider a simplicial  $d$ -polytope  $P$  and identify every face of  $P$  with its vertex set. Following Ziegler (1995, sec. 8.3), for a shelling  $S := F_1, \dots, F_s$  of the boundary complex  $\mathcal{B}(P)$  of  $P$ , we define the *restriction set*  $R_j$  of the facet  $F_j$  as

$$R_j := \{v \in \mathcal{V}(F_j) \mid (\mathcal{V}(F_j) \setminus \{v\}) \subseteq F_i, \text{ for some } i \in [1 \dots j]\}.$$

We use the shelling to build  $\mathcal{B}(P)$ . For  $j \in [2 \dots s]$ , suppose that we have built the subcomplex  $\mathcal{C}_{j-1} := \mathcal{C}(F_1 \cup \dots \cup F_{j-1})$  of  $\mathcal{B}(P)$ . When the facet  $F_j$  is added to  $\mathcal{C}_{j-1}$ , the faces introduced are precisely the faces  $X$  satisfying  $R_j \subseteq X \subseteq F_j$ . Clearly,  $X \subseteq F_j$ . For the other direction, if  $X$  is not new then the definition of a shelling (Definition 2.12.1) gives that  $X \subseteq F_j \cap F_i = F_j \setminus \{v\}$  for some  $F_i$  with  $i < j$  and some  $v \in \mathcal{V}(F_j)$ . But the definition of a restriction set yields that  $v \in R_j$ , ensuring that  $X \not\subseteq R_j$ . We let  $I_j$  be the set of such new faces:

$$I_j := \{X \in \mathcal{B}(P) \mid R_j \subseteq X \subseteq F_j\}. \tag{2.13.9}$$

It follows that  $I_1, \dots, I_s$  is a partition of the faces of  $\mathcal{B}(P)$ . For  $k \in [0 \dots d]$ , let  $h_k(S)$  count the number of restriction sets with cardinality  $k$ :

$$h_k(S) := \#\{j \mid \#R_j = k, \text{ for } j \in [1 \dots s]\}. \tag{2.13.10}$$

From the numbers  $h_0(S), \dots, h_d(S)$ , we can recover the  $f$ -vector of  $P$ . Since  $P$  is simplicial, in the case that  $\#R_j = i$ , by (2.13.9) there are exactly  $\binom{d-i}{k-i}$   $(k-1)$ -faces in  $I_j$ , and thus

$$\begin{aligned} f_{k-1}(P) &:= \sum_{i=0}^k h_i(S) \binom{d-i}{k-i}, \text{ for } k = 0, \dots, d, \\ &= \sum_{i=0}^d h_i(S) \binom{d-i}{k-i}. \end{aligned} \tag{2.13.11}$$

We can also obtain the number  $h_k(S)$  in terms of the  $f$ -vector of  $P$ . For this, we define the two polynomials

$$\varphi_f(x) := \sum_{k=0}^d f_{k-1}(P)x^{d-k} \text{ and } \varphi_h(x) := \sum_{k=0}^d h_k(S)x^{d-k},$$

and using (2.13.11) and  $(x + 1)^{d-i} = \sum_{j=0}^{d-i} \binom{d-i}{j} x^{d-i-j}$  we relate them as

$$\begin{aligned} \varphi_f(x) &= \sum_{k=0}^d f_{k-1}(P)x^{d-k} = \sum_{k=0}^d \left( \sum_{i=0}^d h_i(S) \binom{d-i}{k-i} \right) x^{d-k} \\ &= \sum_{i=0}^d h_i(S) \left( \sum_{j=0}^{d-i} \binom{d-i}{j} x^{d-i-j} \right) = \sum_{i=0}^d h_i(S)(x + 1)^{d-i} = \varphi_h(x + 1). \end{aligned}$$

Equivalently, we have that  $\varphi_f(x - 1) = \varphi_h(x)$ . This, together with the identity  $(x - 1)^{d-i} = \sum_{j=0}^{d-i} (-1)^j \binom{d-i}{j} x^{d-i-j}$ , yields that

$$h_k(S) = \sum_{i=0}^k (-1)^{k-i} \binom{d-i}{k-i} f_{i-1}(P), \text{ for } k = 0, \dots, d. \tag{2.13.12}$$

From (2.13.12) it follows that the  $h_k$  numbers are independent of the shelling  $S$ , and so we will call the sequence  $(h_0, \dots, h_d)$  the  $h$ -vector of  $P$ . The reverse shelling  $S'$  of  $S$  is also a shelling of  $\mathcal{B}(P)$ , where the cardinality of the restriction set  $R'_j$  of the facet  $F_j$  is  $d - k$  if the cardinality of  $R_j$  in  $S$  is  $k$ , and therefore  $h_{d-k}(S') = h_k(S)$ , for  $k \in [0 \dots d]$ . Since the numbers  $h_k$  are independent of any shelling of  $\mathcal{B}(P)$ , it follows that

$$h_{d-k} = h_k, \text{ for } k = 0, \dots, d. \tag{2.13.13}$$

With some effort, and as described in the proof of Grünbaum (2003, thm. 9.2.2), we get that (2.13.13) is another way of writing Dehn–Sommerville’s equations for simplicial polytopes (Theorem 2.13.3).

**Example 2.13.14** (Computation of  $h$ -vectors of simplicial polytopes) Consider the octahedron  $P$  in Fig. 3.5.2(b) and the line shelling  $F_1 := 123, F_2 := 135, F_3 := 234, F_4 := 345, F_5 := 456, F_6 := 156, F_7 := 126, F_8 := 246$  of  $\mathcal{B}(P)$ . For this shelling we have that

$$\begin{aligned} R_1 &:= \emptyset, R_2 := \{5\}, R_3 := \{4\}, R_4 := \{4, 5\}, R_5 := \{6\}, \\ R_6 &:= \{1, 6\}, R_7 := \{2, 6\}, R_8 := \{2, 4, 6\}. \end{aligned}$$

Once we have the restriction sets, using (2.13.9) we get a partition of  $\mathcal{B}(P)$ :

$$\begin{aligned} I_1 &:= \{1, 2, 3, 12, 13, 23, 123\}, I_2 := \{5, 15, 35, 135\}, I_3 := \{4, 24, 34, 234\}, \\ I_4 &:= \{45, 345\}, I_5 := \{6, 46, 56, 456\}, I_6 := \{16, 156\}, I_7 := \{26, 126\}, \\ I_8 &:= \{246\}. \end{aligned}$$

The  $h$ -vector  $(1, 3, 3, 1)$  of  $P$  is computed using (2.13.10):

$$h_0 := 1, h_1 := \#\{2, 3, 5\}, h_2 := \#\{4, 6, 7\}, h_3 := \#\{8\}.$$

Ziegler (1995, ex. 8.22) also illustrates the computation of the  $h$ -vector of the octahedron by considering a shelling and its reverse shelling, both different from the shelling in Example 2.13.14.

### Dehn–Sommerville’s Equations for Cubical Polytopes

The  $f$ -vectors of cubical polytopes satisfy equations that are similar to Dehn–Sommerville’s equations for simplicial polytopes.

**Theorem 2.13.15** (Dehn–Sommerville’s equations for cubical polytopes)<sup>11</sup> *Let  $P$  be a cubical  $d$ -polytope in  $\mathbb{R}^d$ . Then, apart from Euler–Poincaré–Schläfli’s equation:*

$$\sum_{i=-1}^{d-1} (-1)^i f_i(P) = (-1)^{d-1} f_{-1}(P),$$

*the  $f$ -vector of  $P$  satisfies*

$$\sum_{i=k}^{d-1} (-1)^i 2^{i-k} \binom{i}{k} f_i(P) = (-1)^{d-1} f_k(P),$$

*for  $k = 0, \dots, d - 2$ .*

The next corollary of Theorem 2.13.15 is the analogue of Corollary 2.13.8.

**Corollary 2.13.16** *If we consider the  $f$ -vectors of cubical  $d$ -polytopes as points in  $\mathbb{R}^d$ , then they lie in an affine subspace in  $\mathbb{R}^d$  of dimension  $\lfloor d/2 \rfloor$ , and on no affine subspace of smaller dimension.*

Problem 2.15.16 presents a family of  $\lfloor d/2 \rfloor + 1$  cubical  $d$ -polytopes whose  $f$ -vectors are affinely independent in  $\mathbb{R}^d$ .

## 2.14 Gale Transforms

The Gale transform of the vertices of a polytope captures the combinatorial structure of the polytope in a very compact manner. While ideas related to Gale transforms had been exploited by a number of authors, M. A. Perles seemed to have been the first that formalised the method (Grünbaum, 2003, sec. 5.4).

An (*affine*) *point configuration* is a collection  $X := \{\mathbf{x}_1, \dots, \mathbf{x}_n\}$  of  $n$ , not necessarily distinct, points that lies in an affine space  $\mathbb{R}^d$  and that affinely

<sup>11</sup> A proof is available in Grünbaum (2003, sec. 9.4).

spans  $\mathbb{R}^d$ . Similarly, a *vector configuration* is a collection  $X := \{\mathbf{x}_1, \dots, \mathbf{x}_n\}$  of  $n$ , not necessarily distinct, vectors that lies in a linear space  $\mathbb{R}^d$  and that linearly spans  $\mathbb{R}^d$ . In either case, often will we consider the set  $X$  as a sequence  $(\mathbf{x}_1, \dots, \mathbf{x}_n)$  or as a  $d \times n$  matrix with the element  $\mathbf{x}_i$  as the  $i$ th column. A Gale transform of a point configuration  $X$  of  $n$  points in the affine space  $\mathbb{R}^d$  is a vector configuration of  $n$  vectors in the linear space  $\mathbb{R}^{n-d-1}$ . We next develop the machinery to compute Gale transforms.

Given a point configuration  $X := \{\mathbf{x}_1, \dots, \mathbf{x}_n\}$  in  $\mathbb{R}^d$ , the set  $\text{dep } X$  of its *affine dependences* contains all the vectors  $\mathbf{a} \in \mathbb{R}^n$  satisfying  $\mathbf{1}_n \cdot \mathbf{a} = 0$  and  $X\mathbf{a} = \mathbf{0}$ , where  $X$  is viewed as a  $d \times n$  matrix. This is equivalent to stating that

$$\text{dep } X := \left\{ \mathbf{a} = (a_1, \dots, a_n)^t \mid \sum_{i=1}^n a_i = 0 \text{ and } \sum_{i=1}^n a_i \mathbf{x}_i = \mathbf{0}_d \right\}. \tag{2.14.1}$$

We homogenise the configuration  $X$  by associating the vector  $\hat{\mathbf{x}}_i := \begin{pmatrix} \mathbf{x}_i \\ 1 \end{pmatrix} \in \mathbb{R}^{d+1}$  with the point  $\mathbf{x}_i \in \mathbb{R}^d$ . This gives a vector configuration  $\hat{X} := \{\hat{\mathbf{x}}_1, \dots, \hat{\mathbf{x}}_n\}$  in  $\mathbb{R}^{d+1}$  whose set  $\text{ldep } \hat{X}$  of linear dependences coincides with the set  $\text{dep } X$ :

$$\text{ldep } \hat{X} := \left\{ \mathbf{a} = \begin{pmatrix} a_1 \\ \vdots \\ a_n \end{pmatrix} \mid \hat{X}\mathbf{a} = \mathbf{0}_{d+1}, \text{ or, equivalently, } \sum_{i=1}^n a_i \hat{\mathbf{x}}_i = \mathbf{0}_{d+1} \right\}. \tag{2.14.2}$$

**Remark 2.14.3** The sets  $\text{dep } X$  and  $\text{ldep } \hat{X}$  are *symmetric about the origin* or *centrally symmetric*; that is,  $\mathbf{a} \in \text{dep } X$  if and only if  $-\mathbf{a} \in \text{dep } X$ . So it often suffices to record only one element of the pair  $(\mathbf{a}, -\mathbf{a})$ .

For every point configuration  $X$  with  $n \geq d + 1$  points in  $\mathbb{R}^d$ , the set  $\text{dep } X$  is a linear subspace of  $\mathbb{R}^n$  of dimension  $n - d - 1$ . To see this, note that  $\text{dep } X$  coincides with the nullspace of  $\hat{X}$ , where  $\hat{X}$  is viewed as a  $(d + 1) \times n$  matrix. Since  $X$  affinely spans  $\mathbb{R}^d$ , the row vector space of  $\hat{X}$  is  $(d + 1)$ -dimensional. This in turn implies that  $(\text{row } \hat{X})^\perp$ , which coincides with  $\text{null } \hat{X}$ , is  $(n - d - 1)$ -dimensional (Problem 1.12.5).

We now define a Gale transform of a point configuration in  $\mathbb{R}^d$ .

**Definition 2.14.4** (Gale transform) Let  $X := (\mathbf{x}_1, \dots, \mathbf{x}_n)$  be a point configuration in  $\mathbb{R}^d$ , and let  $Y$  be an  $n \times (n - d - 1)$  matrix whose columns  $\mathbf{y}_1, \dots, \mathbf{y}_{n-d-1}$  form a basis in  $\mathbb{R}^n$  of  $\text{dep } X$ . The *Gale transform*  $\mathcal{G}$  of  $X$  is the vector configuration  $\mathcal{G}(X) = (\mathcal{G}(\mathbf{x}_1), \dots, \mathcal{G}(\mathbf{x}_n))$  in  $\mathbb{R}^n$  where  $\mathcal{G}(\mathbf{x}_i)$  is the  $i$ th row of  $Y$ , for each  $i \in [1 \dots n]$ .

Regarding a Gale transform as a matrix gives rise to further observations.

**Remark 2.14.5** Let  $X := (\mathbf{x}_1, \dots, \mathbf{x}_n)$  be a point configuration in  $\mathbb{R}^d$ , and consider the vector configuration  $\widehat{X}$  as a  $(d + 1) \times n$  matrix and the matrix  $Y$  of Definition 2.14.4. If we regard the Gale transform  $\mathcal{G}(X)$  of  $X$  as a  $d \times n$  matrix with columns  $\mathcal{G}(\mathbf{x}_1), \dots, \mathcal{G}(\mathbf{x}_n)$ , then Problems 1.12.4 and 1.12.5 yield that

$$Y^t = \mathcal{G}(X), \text{ null } \widehat{X} = \text{col } Y = \text{row } \mathcal{G}(X), \text{ and } \text{row } \widehat{X} = \text{null } \mathcal{G}(X).$$

When computing a Gale transform of the vertex set  $V$  of a polytope, we view  $V$  as a sequence; we just fix an ordering of the elements of it. Example 2.14.6 exemplifies Definition 2.14.4.

**Example 2.14.6** Consider the 3-polytope of Fig. 2.14.1, whose vertices are

$$\begin{aligned} \mathbf{v}_1 := (0, 0, -1)^t, \mathbf{v}_2 := (1, 0, -1)^t, \mathbf{v}_3 := (0, 1, -1)^t, \mathbf{v}_4 := (0, 0, 1)^t, \\ \mathbf{v}_5 := (1, 2, 1)^t, \mathbf{v}_6 := (0, 1, 1)^t, \end{aligned}$$

and compute a Gale transform of the sequence  $V = (\mathbf{v}_1, \dots, \mathbf{v}_6)$  according to Definition 2.14.4.

We compute a basis of  $\text{dep } V$ , or equivalently, a basis of  $\text{null } \widehat{V}$ . Homogenise the matrix  $V$  formed by the vertices of the polytope, obtaining  $\widehat{V}$ . Choose a basis of  $\text{null } \widehat{V}$ , for instance  $(1, 0, -1, -1, 0, 1)^t$  and  $(0, 1, -1, -2, -1, 3)^t$ , and form the  $2 \times 6$  matrix  $Y$  with the vectors in the basis as columns. Then, the transpose of  $Y$  produces the Gale transform  $\mathcal{G}(V)$  of  $V$  associated with the aforementioned basis. See the matrices  $\widehat{V}$ ,  $Y$ , and  $\mathcal{G}(V)$  below:

$$\widehat{V} = \begin{pmatrix} 0 & 1 & 0 & 0 & 1 & 0 \\ 0 & 0 & 1 & 0 & 2 & 1 \\ -1 & -1 & -1 & 1 & 1 & 1 \\ 1 & 1 & 1 & 1 & 1 & 1 \end{pmatrix}, Y = \begin{pmatrix} 1 & 0 \\ 0 & 1 \\ -1 & -1 \\ -1 & -2 \\ 0 & -1 \\ 1 & 3 \end{pmatrix}$$

and

$$\mathcal{G}(V) = \begin{pmatrix} \mathcal{G}(\mathbf{v}_1) & \mathcal{G}(\mathbf{v}_2) & \mathcal{G}(\mathbf{v}_3) & \mathcal{G}(\mathbf{v}_4) & \mathcal{G}(\mathbf{v}_5) & \mathcal{G}(\mathbf{v}_6) \\ 1 & 0 & -1 & -1 & 0 & 1 \\ 0 & 1 & -1 & -2 & -1 & 3 \end{pmatrix}$$

As expected, a Gale transform of  $V$  consists of six vectors lying in  $\mathbb{R}^2$ ; Fig. 2.14.1(b) depicts a realisation of  $\mathcal{G}(V)$ .

We emphasise that a Gale transform is defined for a point configuration and not for individual points. The next proposition provides some basic properties of Gale transforms.

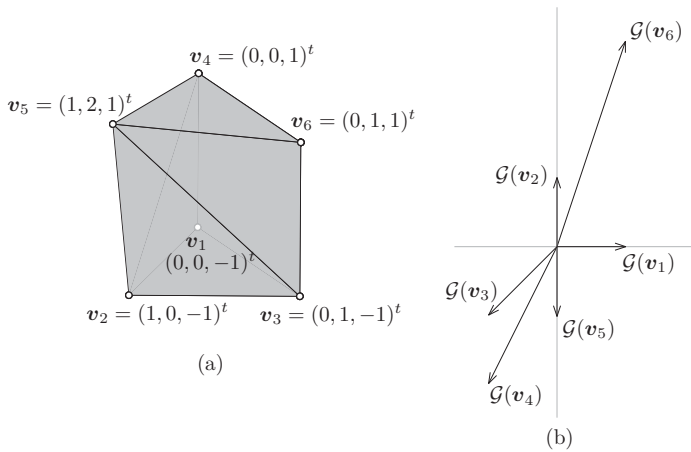

Figure 2.14.1 Computation of a Gale transform of a 3-polytope with six vertices. (a) A realisation of the polytope. (b) A realisation of a Gale transform of the polytope.

**Proposition 2.14.7** Let  $X = (\mathbf{x}_1, \dots, \mathbf{x}_n)$  be a point configuration in  $\mathbb{R}^d$  and let  $\mathcal{G}(X) = (\mathcal{G}(\mathbf{x}_1), \dots, \mathcal{G}(\mathbf{x}_n))$  be a Gale transform of  $X$ . Then the following hold.

- (i) The vectors of  $\mathcal{G}(X)$  need not be all distinct.
- (ii) The vectors of  $\mathcal{G}(X)$  satisfy  $\sum_{i=1}^n \mathcal{G}(\mathbf{x}_i) = \mathbf{0}_{n-d-1}$ , and  $\mathcal{G}(X)$  linearly spans  $\mathbb{R}^{n-d-1}$ .
- (iii) The vectors of  $\mathcal{G}(X)$  positively span  $\mathbb{R}^{n-d-1}$ .
- (iv) Every open halfspace bounded by a linear hyperplane in  $\mathbb{R}^{n-d-1}$  contains at least one vector from  $\mathcal{G}(X)$ .
- (v) The points of  $X$  are in (affine) general position in  $\mathbb{R}^d$  – that is, no  $d + 1$  of them lie in a hyperplane – if and only if the vectors of  $\mathcal{G}(X)$  are in linear general position in  $\mathbb{R}^{n-d-1}$ ; that is, no  $n - d - 1$  of them lie in a linear hyperplane.
- (vi) A Gale transform is determined up to linear isomorphism. In other words, suppose that  $Y = (\mathbf{y}_1, \dots, \mathbf{y}_{n-d-1})$  and  $Z = (\mathbf{z}_1, \dots, \mathbf{z}_{n-d-1})$  are two bases of  $\text{dep } X$  so that  $YA = Z$  for a nonsingular matrix  $A$ . And suppose that  $\mathcal{G}_Y$  and  $\mathcal{G}_Z$  are the Gale transforms of  $X$  associated with  $Y$  and  $Z$  (Definition 2.14.4). Then, for each  $i \in [1 \dots n]$ , we have that

$$\mathcal{G}_Z(\mathbf{x}_i) = A^t \mathcal{G}_Y(\mathbf{x}_i).$$

*Proof* We provide a proof of (vi), and leave the rest to the reader.



Let  $Y := (y_1, \dots, y_{n-d-1})$  be a basis in  $\mathbb{R}^n$  of  $\text{dep } X$  and let

$$(\mathcal{G}(x_1), \dots, \mathcal{G}(x_n))$$

be the Gale transform of  $X$  associated with the basis  $Y$  (Definition 2.14.4). Choose another basis in  $\mathbb{R}^{n-d-1}$  of  $\text{dep } X$ , say  $z_1, \dots, z_{n-d-1}$ , and let  $Z$  be the  $n \times (n - d - 1)$  matrix having  $z_i$  as its  $i$ th column. Then we obtain the equality  $YA = Z$  where  $A = (a_{i,j})$  is a nonsingular  $(n - d - 1) \times (n - d - 1)$  matrix and  $z_i = a_{1,i}y_1 + \dots + a_{n-d-1,i}y_{n-d-1}$  for each  $i \in [1 \dots n - d - 1]$ . In this setting, the sequence

$$(A^t \mathcal{G}(x_1), \dots, A^t \mathcal{G}(x_n))$$

is the Gale transform of  $X$  associated with the basis  $Z$ . □

Henceforth, we talk of *the* Gale transform of a point configuration, with the understanding stated in Proposition 2.14.7(vi).

While we have stressed that the elements of a Gale transform should be understood as vectors in a linear space  $\mathbb{R}^m$ , sometimes we need to interpret them as points in the affine space  $\mathbb{R}^m$  so that we can carry out operations on them such as convex hulls. Theorem 2.14.8 exemplifies this situation and shows how to query a Gale transform.

**Theorem 2.14.8**<sup>12</sup> *Let  $V := \{v_1, \dots, v_n\}$  be a point configuration in  $\mathbb{R}^d$  and let  $\mathcal{G}(V) := (\mathcal{G}(v_1), \dots, \mathcal{G}(v_n))$  be the Gale transform of  $V$ . Moreover, let  $W \subset V$  and let  $\mathcal{G}(W)$  be the restriction of  $\mathcal{G}(V)$  to the points in  $W$ . The set  $\text{conv } W$  is a proper face of the  $d$ -polytope  $\text{conv } V$  if and only if  $\mathbf{0}_{n-d-1} \in \text{rint}(\text{conv}(\mathcal{G}(V) \setminus \mathcal{G}(W)))$ .*

We test Theorem 2.14.8 on the 3-polytope of Fig. 2.14.1.

**Example 2.14.9** Let  $V := \{v_1, \dots, v_6\}$  be the vertex set of the 3-polytope  $P$  of Fig. 2.14.1, and let  $\mathcal{G}(V) := (\mathcal{G}(v_1), \dots, \mathcal{G}(v_6))$  be the Gale transform of  $V$ . Applying Theorem 2.14.8 to  $\mathcal{G}(V)$  yields the following.

- (i) The vertex sets of the edges of  $P$  incident with  $v_1$  are  $W_1 := \{v_1, v_2\}$ ,  $W_2 := \{v_1, v_4\}$ , and  $W_3 := \{v_1, v_3\}$ , as  $\mathbf{0}_2 \in \text{rint}(\text{conv}(\mathcal{G}(V) \setminus \mathcal{G}(W_i)))$  for  $i = 1, 2, 3$ . It also follows that the sets  $\{v_1, v_5\}$  and  $\{v_1, v_6\}$  are not edges of  $P$ .
- (ii) The vertex sets of the 2-faces of  $P$  incident with  $v_1$  are  $W_4 := \{v_1, v_2, v_3\}$ ,  $W_5 := \{v_1, v_2, v_4\}$ , and  $W_6 := \{v_1, v_3, v_4, v_6\}$ , as  $\mathbf{0}_2 \in \text{rint}(\text{conv}(\mathcal{G}(V) \setminus \mathcal{G}(W_i)))$  for  $i = 4, 5, 6$ .

<sup>12</sup> A proof is available in Webster (1994, thm. 3.6.6).

The power of the Gale transform (and Theorem 2.14.8) comes to light when dealing with  $d$ -polytopes that have  $d + 2$ ,  $d + 3$ , or  $d + 4$  vertices, since in these cases the transforms lie in  $\mathbb{R}$ ,  $\mathbb{R}^2$ , and  $\mathbb{R}^3$ , respectively. Its power is also visible when studying pyramids and simplicial polytopes.

**Theorem 2.14.10**<sup>13</sup> *Let  $P$  be a polytope with vertex set  $V$  and let  $\mathcal{G}(V)$  be the Gale transform of  $V$ . Then  $P$  is a pyramid with apex  $v$  if and only if  $\mathcal{G}(v) = \mathbf{0}$ . Furthermore, the Gale transform of the base  $\text{conv}(V \setminus \{v\})$  of  $P$  is  $\mathcal{G}(V) \setminus \{\mathcal{G}(v)\}$ .*

A corollary immediately ensues.

**Corollary 2.14.11** *Let  $P$  be a polytope with vertex set  $V$  and let  $\mathcal{G}(V)$  be the Gale transform of  $V$ . Then  $P$  is an  $r$ -fold pyramid with apices  $v_1, \dots, v_r$  if and only if  $\mathcal{G}(v_1) = \dots = \mathcal{G}(v_r) = \mathbf{0}$ .*

A  $d$ -simplex is a  $d$ -fold pyramid over a 0-simplex, which combined with Proposition 2.14.7 yields the following.

**Corollary 2.14.12** *Let  $\{v_1, \dots, v_{d+1}\}$  be the vertex set of a  $d$ -simplex. Then  $\mathcal{G}(v_1) = \dots = \mathcal{G}(v_{d+1}) = \mathbf{0}$ .*

As in the case of pyramids, Gale transforms of simplicial polytopes can be easily characterised.

**Theorem 2.14.13**<sup>14</sup> *Let  $\mathcal{G}$  be the Gale transform of a  $d$ -polytope on  $n$  vertices. The polytope is simplicial if and only if  $\mathbf{0} \notin \text{rint}(\text{conv}(\mathcal{G} \cap H))$  for every linear hyperplane  $H$  in  $\mathbb{R}^{n-d-1}$ .*

The computation described in Definition 2.14.4 can certainly be applied to a point configuration  $X$  in  $\mathbb{R}^d$  that does not represent the vertices of a polytope. So how can we tell if the sequence  $X$  is in convex position? Theorem 2.14.14 provides an answer.

**Theorem 2.14.14**<sup>15</sup> *A sequence  $\mathcal{G}(V) := (\mathcal{G}(v_1), \dots, \mathcal{G}(v_n))$  of vectors in  $\mathbb{R}^{n-d-1}$  is the Gale transform of a  $d$ -polytope (other than the simplex) with vertex set  $V$  if and only if*

- (i)  $\sum_{i=1}^n \mathcal{G}(v_i) = \mathbf{0}_{n-d-1}$  and,
- (ii) every open halfspace bounded by a linear hyperplane in  $\mathbb{R}^{n-d-1}$  contains at least two vectors of  $\mathcal{G}(V)$ .

<sup>13</sup> A proof is available in McMullen and Shephard (1971, thm. 3).

<sup>14</sup> A proof is available in Webster (1994, thm. 3.6.9).

<sup>15</sup> A proof is available in Webster (1994, thm. 3.6.8).

Projectively isomorphic polytopes can be told from their corresponding Gale transforms, and so can affinely isomorphic polytopes. Two polytopes  $P$  and  $P'$  are *affinely isomorphic* if there is an affine isomorphism  $\varrho$  such that  $\varrho(P) = P'$ .

**Theorem 2.14.15** (Grünbaum 2003, thms. 5.4.6–4.7) *Let  $P$  and  $P'$  be two polytopes, let  $V = \{v_1, \dots, v_n\}$  and  $V' = \{v'_1, \dots, v'_n\}$  be their respective vertex sets, and let  $(\mathcal{G}(v_1), \dots, \mathcal{G}(v_n))$  and  $(\mathcal{G}(v'_1), \dots, \mathcal{G}(v'_n))$  be their respective Gale transforms. Then the following hold.*

- (i) *There is an affine isomorphism  $\varrho$  between  $P$  and  $P'$  with  $\varrho(v_i) = v'_i$  if and only if there is a nonsingular matrix  $A$  such that  $\mathcal{G}(v'_i) = A \mathcal{G}(v_i)$  for each  $i \in [1 \dots n]$ .*
- (ii) *There is a projective isomorphism  $\zeta$  between  $P$  and  $P'$  that is admissible for  $P$  and satisfies  $\zeta(v_i) = v'_i$  if and only if there is a nonsingular matrix  $A$  and positive scalars  $\alpha_1, \dots, \alpha_n$  such that  $\mathcal{G}(v'_i) = \alpha_i A \mathcal{G}(v_i)$  for each  $i \in [1 \dots n]$ .*

If the vectors of the Gale transform  $\mathcal{G}$  of a polytope  $P$  are multiplied by positive scalars, then we obtain a vector configuration  $\mathcal{S}$  that will produce the same face lattice as  $\mathcal{G}$  when we apply Theorem 2.14.8 to it. But  $\mathcal{S}$  may not satisfy all the properties of a Gale transform (Proposition 2.14.7); in particular, the sum of vectors of  $\mathcal{S}$  may not result in the zero vector. We say that a *Gale diagram* of a  $d$ -polytope on  $n$  vertices is a vector configuration  $\mathcal{S}$  with  $n$  vectors in  $\mathbb{R}^{n-d-1}$  that produces the face lattice of the polytope when we apply Theorem 2.14.8 to it. It follows that Gale diagrams generalise Gale transforms. In this context, we say that two Gale diagrams of polytopes are *isomorphic* if they produce isomorphic face lattices.

It is customary to *normalise* the vectors of a Gale diagram and call the resulting configuration a *standard Gale diagram*, as done in McMullen and Shephard (1971, p. 138). For Grünbaum (2003, sec. 5.4), however, every Gale diagram is a standard Gale diagram. From a Gale diagram

$$\mathcal{G}(X) := (\mathcal{G}(x_1), \dots, \mathcal{G}(x_n)),$$

a standard Gale diagram  $\mathcal{G}'(X)$  can be obtained as follows:

$$\mathcal{G}'(X) := \begin{cases} \mathcal{G}(x_i), & \text{if } \mathcal{G}(x_i) = \mathbf{0}; \\ \frac{\mathcal{G}(x_i)}{\|x_i\|}, & \text{otherwise.} \end{cases} \tag{2.14.16}$$

The new configuration  $\mathcal{G}'$  of vectors is a subset of  $\{\mathbf{0}\} \cup \mathbb{S}^{n-d-2}$ . And by virtue of Theorem 2.14.8, the sequence  $\mathcal{G}'(X)$  is endowed with the same combinatorial properties of  $\mathcal{G}(X)$ . In drawing the diagram  $\mathcal{G}'$  on  $\{\mathbf{0}\} \cup \mathbb{S}^{n-d-2}$ ,

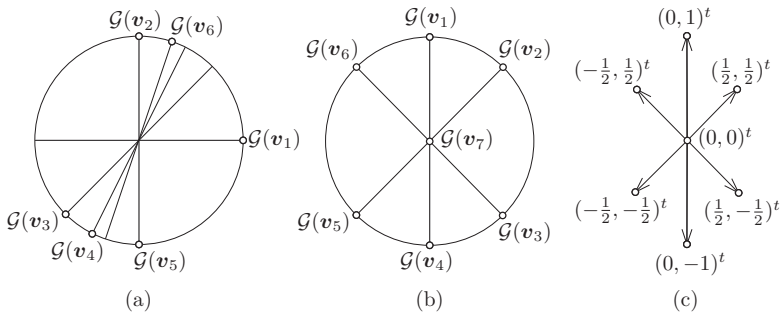

Figure 2.14.2 Gale diagrams of polytopes. (a) The standard Gale diagram corresponding to the Gale transform of Fig. 2.14.1(b). (b) The standard Gale diagram of a pyramidal 4-polytope. (c) A Gale transform isomorphic to the Gale diagram in (b).

we draw the sphere and extend each vector so that it becomes a diameter of the sphere, as in Fig. 2.14.2(a)–(b). In what follows, we normalise our Gale diagrams.

When we are interested only in the face lattice that results from applying Theorem 2.14.8 to a Gale transform, we will resort to Gale diagrams without specifying concrete vectors. The next result is the combinatorial equivalent of Theorem 2.14.15.

**Theorem 2.14.17** *Let  $P$  and  $P'$  be two polytopes with vertex sets  $V$  and  $V'$ , respectively, and let  $\mathcal{G}(V)$  and  $\mathcal{G}(V')$  be their respective Gale diagrams. The polytopes are combinatorially isomorphic if and only if their Gale diagrams are isomorphic.*

We have learnt how to construct the Gale transform of a polytope given its vertices (Definition 2.14.4), and how to produce the face lattice of a polytope  $P$  from its Gale diagram (Theorem 2.14.8). But what about if we want a realisation of a polytope that is combinatorially isomorphic to  $P$ ; Example 2.14.18 demonstrates how to do so.

**Example 2.14.18** Produce a realisation of a polytope  $P$  that is combinatorially isomorphic to a polytope whose Gale diagram  $\mathcal{G}$  appears in Fig. 2.14.2(b). Let  $V := \mathcal{V}(P)$ .

Figure 2.14.2(b) first reveals that  $P$  has  $n = 7$  vertices and dimension  $d = 4$ , as the Gale diagram lies in  $\{0\} \cup \mathbb{S}$ . Moreover,  $P$  is a pyramid because  $\mathcal{G}(v_7) = \mathbf{0}$  (Theorem 2.14.10). To produce a realisation of  $P$ , we produce a Gale transform  $\mathcal{G}'$  isomorphic to  $\mathcal{G}$  by associating concrete vectors in  $\mathbb{R}^2$  that

are nonzero multiples of the vectors in  $\mathcal{G}$  and whose sum is  $\mathbf{0}_2$ . Possible vectors are given below.

$$\mathcal{G}'(V) = \begin{pmatrix} \mathcal{G}'(\mathbf{v}_1) & \mathcal{G}'(\mathbf{v}_2) & \mathcal{G}'(\mathbf{v}_3) & \mathcal{G}'(\mathbf{v}_4) & \mathcal{G}'(\mathbf{v}_5) & \mathcal{G}'(\mathbf{v}_6) & \mathcal{G}'(\mathbf{v}_7) \\ 0 & \frac{1}{2} & \frac{1}{2} & 0 & -\frac{1}{2} & -\frac{1}{2} & 0 \\ 1 & \frac{1}{2} & -\frac{1}{2} & -1 & -\frac{1}{2} & \frac{1}{2} & 0 \end{pmatrix}.$$

The rows of  $\mathcal{G}'(V)$  form a basis of  $\text{dep } V$  or, equivalently, a basis of  $\text{null } \widehat{V}$  or, equivalently, a basis of  $(\text{row } \widehat{V})^\perp$  by Problem 1.12.5. We are looking for a basis of  $\text{row } \widehat{V}$  or, equivalently, a basis  $B$  of  $\text{null } \mathcal{G}'(V)$  that includes the all-one vector (Remark 2.14.5). After finding the basis  $B$ , the matrix  $\widehat{V}$  is constructed by placing the vectors of  $B$  as rows, with the all-one vector as the last row. The matrices  $V$  and  $\widehat{V}$  are given below, from left to right.

$$\begin{pmatrix} \mathbf{v}_1 & \mathbf{v}_2 & \mathbf{v}_3 & \mathbf{v}_4 & \mathbf{v}_5 & \mathbf{v}_6 & \mathbf{v}_7 \\ -1 & 1 & 0 & 0 & 0 & 1 & 0 \\ 0 & 1 & 0 & 0 & 1 & 0 & 0 \\ 1 & 0 & 0 & 1 & 0 & 0 & 0 \\ 1 & -1 & 1 & 0 & 0 & 0 & 0 \end{pmatrix}, \begin{pmatrix} -1 & 1 & 0 & 0 & 0 & 1 & 0 \\ 0 & 1 & 0 & 0 & 1 & 0 & 0 \\ 1 & 0 & 0 & 1 & 0 & 0 & 0 \\ 1 & -1 & 1 & 0 & 0 & 0 & 0 \\ 1 & 1 & 1 & 1 & 1 & 1 & 1 \end{pmatrix}.$$

### Applications of Gale Diagrams

Gale diagrams facilitate the description and enumeration of  $d$ -polytopes with  $d + 2$  and  $d + 3$  vertices. The case of  $d + 2$  vertices is not as complicated as the case of  $d + 3$  vertices (Fusy, 2006), which makes it appropriate for a neat application of Gale diagrams. See Fig. 2.14.3.

**Theorem 2.14.19**<sup>16</sup> *There are precisely  $\lfloor d^2/4 \rfloor$  nonisomorphic  $d$ -polytopes with  $d + 2$  vertices. Among these, the  $\lfloor d/2 \rfloor$  simplicial  $d$ -polytopes are direct sums of simplices, namely  $T(r) \oplus T(s)$  with  $r, s \geq 1$  and  $r + s = d$ . The remaining nonsimplicial  $d$ -polytopes are  $t$ -fold pyramids over  $T(r) \oplus T(s)$  with  $r, s, t \geq 1$  and  $r + s + t = d$ .*

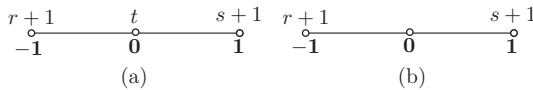

Figure 2.14.3 Gale diagrams of  $d$ -polytopes with  $d + 2$  vertices. (a) The Gale diagrams corresponding to nonsimplicial polytopes. (b) The Gale diagrams corresponding to simplicial polytopes.

<sup>16</sup> A proof is available in Webster (1994, thm. 3.6.10).

### Affine Gale Diagrams

As Theorem 2.14.8 demonstrates, the combinatorial structure of a  $d$ -polytope on  $n$  vertices can be read off from its Gale transform on  $\mathbb{R}^{n-d-1}$ . It turns out that this can also be done from a point configuration on  $\mathbb{R}^{n-d-2}$ , from affine Gale diagrams. This reduction in dimension means that if  $n - d - 1 = 3$ , then the Gale transform would lie in  $\mathbb{R}^3$ , but an affine Gale diagram would lie in  $\mathbb{R}^2$ . Sturmfels (1988) seems to have been the first to utilise affine Gale diagrams.

Affine Gale diagrams are central projections of Gale transforms onto nonlinear hyperplanes. Let  $V := \{v_1, \dots, v_n\}$  be the vertex set of a  $d$ -polytope  $\text{conv } V$  and let  $\mathcal{G}$  be the Gale transform of  $V$ . We choose a nonlinear hyperplane  $H := \{x \in \mathbb{R}^{n-d-1} \mid a \cdot x = 1\}$  not parallel to any vector in  $\mathcal{G}$ ; that is,  $a \cdot \mathcal{G}(v_i) \neq 0$  for each  $i \in [1 \dots n]$ . Centrally project each nonzero vector  $\mathcal{G}(v_i)$  of  $\mathcal{G}$  onto a point  $\mathcal{G}_a(v_i)$  in  $H$ : the vector  $\mathcal{G}(v_i)$  is mapped to the intersection  $\mathcal{G}_a(v_i)$  of  $H$  and a line through  $\mathbf{0}$  and  $\mathcal{G}(v_i)$ . Notationally, we have that

$$\mathcal{G}_a(v_i) := \frac{\mathcal{G}(v_i)}{a \cdot \mathcal{G}(v_i)}, \text{ for each } i \in [1 \dots n]. \tag{2.14.20}$$

The *affine Gale diagram*  $\mathcal{G}_a$  of  $V$  is the point configuration

$$\mathcal{G}_a(V) = (\mathcal{G}_a(v_1), \dots, \mathcal{G}_a(v_n)). \tag{2.14.21}$$

We need to distinguish between a point  $\mathcal{G}_a(v_i)$  obtained from a vector  $\mathcal{G}(v_i)$  directed towards  $H$ , one satisfying  $a \cdot \mathcal{G}(v_i) > 0$ , and a point obtained from vectors  $\mathcal{G}(v_i)$  directed away from  $H$ , one satisfying  $a \cdot \mathcal{G}(v_i) < 0$ . Call the former point *positive*, and if a differentiation is necessary, denote it  $\mathcal{G}_a^+(v_i)$ ; and call the latter point *negative* and denote it  $\mathcal{G}_a^-(v_i)$ , if necessary. The set of positive points of  $\mathcal{G}_a(V)$  will be denoted by  $\mathcal{G}_a^+(V)$ , while the set of negative points will be denoted by  $\mathcal{G}_a^-(V)$ . A zero vector  $\mathcal{G}(v_i)$  has no central projection onto  $H$  and so is a *special point*. To realise the reduction in dimension, we need an isomorphism  $\sigma$  between  $H$  and  $\mathbb{R}^{n-d-2}$ ; since  $a = (a_1, \dots, a_{n-d-1})^t$  is nonzero, there exists  $a_i \neq 0$ , which implies that the projection ‘deleting’ the  $i$  coordinate of each  $\mathcal{G}_a(v_i)$  does the trick. For the sake of simplicity, we also denote by  $\mathcal{G}_a(v_i)$  the point  $\sigma(\mathcal{G}_a(v_i))$  and denote by  $\mathcal{G}_a(V)$  the set of these points in  $\mathbb{R}^{n-d-2}$ . Finally, to depict  $\mathcal{G}_a(V)$  in  $\mathbb{R}^{n-d-2}$ , we draw the positive points with black dots, the negative points with white dots, and specify the number of special points by drawing a grey point and a number. We exemplify the construction of an affine Gale diagram for the Gale transform in Fig. 2.14.1(b).

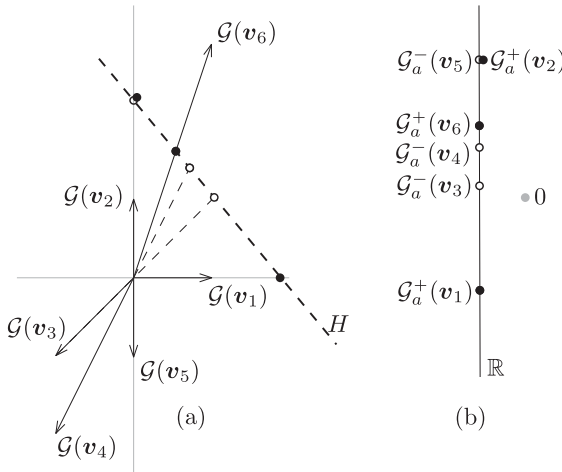

Figure 2.14.4 An affine Gale diagram from a Gale transform. (a) A realisation of the Gale transform  $\mathcal{G}$  in Fig. 2.14.1(b), a nonlinear hyperplane  $H$ , and the central projection of the vectors in  $\mathcal{G}$  onto  $H$ . (b) A realisation of an affine Gale diagram  $\mathcal{G}_a$  for  $\mathcal{G}$ .

**Example 2.14.22** Consider the Gale transform in Fig. 2.14.1(b):

$$\mathcal{G}(V) = \begin{pmatrix} \mathcal{G}(v_1) & \mathcal{G}(v_2) & \mathcal{G}(v_3) & \mathcal{G}(v_4) & \mathcal{G}(v_5) & \mathcal{G}(v_6) \\ 1 & 0 & -1 & -1 & 0 & 1 \\ 0 & 1 & -1 & -2 & -1 & 3 \end{pmatrix}.$$

We choose  $\mathbf{a} := (1/2, 1/2)^t$ , compute the affine Gale diagram

$$\begin{aligned} \mathcal{G}_a(v_1) &:= \frac{\mathcal{G}(v_1)}{\mathbf{a} \cdot \mathcal{G}(v_1)} = \begin{pmatrix} 2 \\ 0 \end{pmatrix}, & \mathcal{G}_a(v_2) &:= \frac{\mathcal{G}(v_2)}{\mathbf{a} \cdot \mathcal{G}(v_2)} = \begin{pmatrix} 0 \\ 2 \end{pmatrix}, \\ \mathcal{G}_a(v_3) &:= \frac{\mathcal{G}(v_3)}{\mathbf{a} \cdot \mathcal{G}(v_3)} = \begin{pmatrix} 1 \\ 1 \end{pmatrix}, & \mathcal{G}_a(v_4) &:= \frac{\mathcal{G}(v_4)}{\mathbf{a} \cdot \mathcal{G}(v_4)} = \begin{pmatrix} 2/3 \\ 4/3 \end{pmatrix}, \\ \mathcal{G}_a(v_5) &:= \frac{\mathcal{G}(v_5)}{\mathbf{a} \cdot \mathcal{G}(v_5)} = \begin{pmatrix} 0 \\ 2 \end{pmatrix}, & \mathcal{G}_a(v_6) &:= \frac{\mathcal{G}(v_6)}{\mathbf{a} \cdot \mathcal{G}(v_6)} = \begin{pmatrix} 1/2 \\ 3/2 \end{pmatrix}, \end{aligned}$$

and project the points onto the  $x_2 = 0$  hyperplane to produce

$$\begin{aligned} \mathcal{G}_a(v_1) &:= 2, & \mathcal{G}_a(v_2) &:= 0, & \mathcal{G}_a(v_3) &:= 1, & \mathcal{G}_a(v_4) &:= 2/3, & \mathcal{G}_a(v_5) &:= 0, \\ & & & & & & \mathcal{G}_a(v_6) &:= 1/2. \end{aligned}$$

There is no special point in  $\mathcal{G}_a$ . As expected, an affine Gale diagram of  $V$  consists of six points lying in  $\mathbb{R}^1$ ; Figure 2.14.4(b) depicts  $\mathcal{G}_a(V)$ .

Affine Gale diagrams convey the same combinatorial information as Gale transforms and Gale diagrams, as we now demonstrate.

**Theorem 2.14.23** *Let  $V := \{v_1, \dots, v_n\}$  be a point configuration in  $\mathbb{R}^d$  and  $\mathcal{G}_a(V) := (\mathcal{G}_a(v_1), \dots, \mathcal{G}_a(v_n))$  an affine Gale diagram of  $V$  with no special points. Moreover, let  $W \subset V$  and let  $\mathcal{G}_a(W)$  be the restriction of  $\mathcal{G}_a(V)$  to the points in  $W$ . The set  $\text{conv } W$  is a proper face of the  $d$ -polytope  $\text{conv } V$  if and only if*

$$\text{rint}(\text{conv}(\mathcal{G}_a^+(V) \setminus \mathcal{G}_a^+(W))) \cap \text{rint}(\text{conv}(\mathcal{G}_a^-(V) \setminus \mathcal{G}_a^-(W))) \neq \emptyset.$$

*Proof* It suffices that the condition of this theorem is equivalent to the condition of Theorem 2.14.8. Let  $\mathcal{G}(V) := \{\mathcal{G}(v_1), \dots, \mathcal{G}(v_n)\}$  be the Gale transform and  $H := \{x \in \mathbb{R}^{n-d-1} \mid a \cdot x = 1\}$  the hyperplane in  $\mathbb{R}^{n-d-1}$  used in the computation of  $\mathcal{G}_a$ . Assume that  $\mathcal{G}_a(V)$  lies in  $H \cap \mathbb{R}^{n-d-1}$ . Further, without loss of generality assume that  $\mathcal{G}(V) \setminus \mathcal{G}(W) = \{v_1, \dots, v_k\}$ . We partition the set  $I = \{1, \dots, k\}$  into two subsets  $I^+$  and  $I^-$  according to the sign of  $a \cdot \mathcal{G}(v_i)$ . That is,

$$I^+ := \{i \in I \mid a \cdot \mathcal{G}(v_i) > 0\} \text{ and } I^- := \{j \in I \mid a \cdot \mathcal{G}(v_j) < 0\}.$$

Suppose that  $\mathbf{0}_{n-d-1} \in \text{rint}(\text{conv}(\mathcal{G}(V) \setminus \mathcal{G}(W)))$ . By Theorem 1.7.6, this is equivalent to the existence of positive scalars  $\alpha_1, \dots, \alpha_k$  satisfying  $\sum_{i=1}^k \alpha_i = 1$  and  $\mathbf{0}_{n-d-1} = \sum_{i=1}^k \alpha_i \mathcal{G}(v_i)$ , which in turn implies that

$$\sum_{i \in I^+} \alpha_i \mathcal{G}(v_i) = - \sum_{j \in I^-} \alpha_j \mathcal{G}(v_j) \tag{2.14.23.1}$$

and that

$$\sum_{i \in I^+} \alpha_i a \cdot \mathcal{G}(v_i) = - \sum_{j \in I^-} \alpha_j a \cdot \mathcal{G}(v_j). \tag{2.14.23.2}$$

From (2.14.23.2), it is clear that both  $I^+$  and  $I^-$  are nonempty. We show the existence of a point

$$x \in \text{rint}(\text{conv}(\mathcal{G}_a^+(V) \setminus \mathcal{G}_a^+(W))) \cap \text{rint}(\text{conv}(\mathcal{G}_a^-(V) \setminus \mathcal{G}_a^-(W))),$$

which would settle the first direction.

Let  $\alpha := \sum_{i \in I^+} \alpha_i a \cdot \mathcal{G}(v_i)$  and let

$$x := \sum_{i \in I^+} \frac{\alpha_i a \cdot \mathcal{G}(v_i)}{\alpha} \mathcal{G}_a(v_i) = \sum_{i \in I^+} \frac{\alpha_i a \cdot \mathcal{G}(v_i)}{\alpha} \frac{\mathcal{G}(v_i)}{a \cdot \mathcal{G}(v_i)}. \tag{2.14.23.3}$$

Since  $a \cdot \mathcal{G}(v_i) > 0$  for  $i \in I^+$  and  $\alpha_i > 0$ , we find that  $\alpha_i a \cdot \mathcal{G}(v_i) / \alpha > 0$  and  $\alpha > 0$ , which combined with  $\sum_{i \in I^+} (\alpha_i a \cdot \mathcal{G}(v_i)) / \alpha = 1$  give that

$$x \in \text{rint}(\text{conv}(\mathcal{G}_a^+(V) \setminus \mathcal{G}_a^+(W))).$$



On the other hand,  $\alpha = -\sum_{j \in I^-} \alpha_j \mathbf{a} \cdot \mathcal{G}(\mathbf{v}_j)$  by (2.14.23.2). So from (2.14.23.1) and (2.14.23.3), it follows that

$$\mathbf{x} = \sum_{j \in I^-} \frac{(-\alpha_j) \mathbf{a} \cdot \mathcal{G}(\mathbf{v}_j)}{\alpha} \mathcal{G}_a(\mathbf{v}_j) = \sum_{j \in I^-} \frac{(-\alpha_j) \mathbf{a} \cdot \mathcal{G}(\mathbf{v}_j)}{\alpha} \frac{\mathcal{G}(\mathbf{v}_j)}{\mathbf{a} \cdot \mathcal{G}(\mathbf{v}_j)},$$

which implies  $\mathbf{x} \in \text{rint}(\text{conv}(\mathcal{G}_a^-(V) \setminus \mathcal{G}_a^-(W)))$ , as desired.

For the other direction, suppose that there exists a point  $\mathbf{x} \in H$  satisfying

$$\mathbf{x} \in \text{rint}(\text{conv}(\mathcal{G}_a^+(V) \setminus \mathcal{G}_a^+(W))) \cap \text{rint}(\text{conv}(\mathcal{G}_a^-(V) \setminus \mathcal{G}_a^-(W))).$$

Then

$$\mathbf{x} = \sum_{i \in I^+} \beta_i \mathcal{G}_a(\mathbf{v}_i), \text{ with } \beta_i > 0 \text{ for } i \in I^+ \text{ and } \sum_{i \in I^+} \beta_i = 1,$$

$$\mathbf{x} = \sum_{j \in I^-} \beta_j \mathcal{G}_a(\mathbf{v}_j), \text{ with } \beta_j > 0 \text{ for } j \in I^- \text{ and } \sum_{j \in I^-} \beta_j = 1,$$

which yields that

$$\begin{aligned} \mathbf{0}_{n-d-1} &= \sum_{i \in I^+} \beta_i \mathcal{G}_a(\mathbf{v}_i) + \sum_{j \in I^-} (-\beta_j) \mathcal{G}_a(\mathbf{v}_j) \\ &= \sum_{i \in I^+} \beta_i \frac{\mathcal{G}(\mathbf{v}_i)}{\mathbf{a} \cdot \mathcal{G}(\mathbf{v}_i)} + \sum_{j \in I^-} (-\beta_j) \frac{\mathcal{G}(\mathbf{v}_j)}{\mathbf{a} \cdot \mathcal{G}(\mathbf{v}_j)}. \end{aligned}$$

Since  $\beta_i / (\mathbf{a} \cdot \mathcal{G}(\mathbf{v}_i)) > 0$  for  $i \in I^+$  and  $(-\beta_j) / (\mathbf{a} \cdot \mathcal{G}(\mathbf{v}_j)) > 0$  for  $j \in I^-$ , it follows that

$$\mathbf{0}_{n-d-1} \in \text{rint}(\text{conv}\{\mathcal{G}(\mathbf{v}_1), \dots, \mathcal{G}(\mathbf{v}_k)\}) = \text{rint}(\text{conv}(\mathcal{G}(V) \setminus \mathcal{G}(W))).$$

If  $\sigma$  is an isomorphism from  $H$  to  $\mathbb{R}^{n-d-2}$ , then it is clear that any positive combination involving  $\mathbf{x}$  and points in  $\mathcal{G}_a$  will remain valid under  $\sigma$ . This completes the proof of the theorem. □

We test Theorem 2.14.23 with the polytope in Fig. 2.14.1.

**Example 2.14.24** Let  $V := \{\mathbf{v}_1, \dots, \mathbf{v}_6\}$  be the vertex set of the 3-polytope  $P$  of Fig. 2.14.1 and let  $\mathcal{G}_a(V) := (\mathcal{G}_a(\mathbf{v}_1), \dots, \mathcal{G}_a(\mathbf{v}_6))$  be an affine Gale diagram of  $V$ . We have that  $\mathcal{G}_a^+(V) := \{\mathcal{G}_a^+(\mathbf{v}_1), \mathcal{G}_a^+(\mathbf{v}_2), \mathcal{G}_a^+(\mathbf{v}_6)\}$  and  $\mathcal{G}_a^-(V) := \{\mathcal{G}_a^-(\mathbf{v}_3), \mathcal{G}_a^-(\mathbf{v}_4), \mathcal{G}_a^-(\mathbf{v}_5)\}$ . Applying Theorem 2.14.23 to  $\mathcal{G}_a(V)$  yields the following.

- (i) The sets  $W_1 := \{\mathbf{v}_1, \mathbf{v}_2\}$ ,  $W_2 := \{\mathbf{v}_1, \mathbf{v}_4\}$ , and  $W_3 := \{\mathbf{v}_1, \mathbf{v}_3\}$  are edges of  $P$ , as

$$\text{rint}(\text{conv}(\mathcal{G}_a^+(V) \setminus \mathcal{G}_a^+(W_i))) \cap \text{rint}(\text{conv}(\mathcal{G}_a^-(V) \setminus \mathcal{G}_a^-(W_i))) \neq \emptyset$$

for  $i = 1, 2, 3$ . It also follows that the set  $W'_1 := \{v_1, v_6\}$  is not an edge of  $P$  since

$$\text{rint}(\text{conv}(\mathcal{G}_a^+(V) \setminus \mathcal{G}_a^+(W'_1))) \cap \text{rint}(\text{conv}(\mathcal{G}_a^-(V) \setminus \mathcal{G}_a^-(W'_1))) = \emptyset.$$

However, observe that

$$\text{conv}(\mathcal{G}_a^+(V) \setminus \mathcal{G}_a^+(W'_1)) \cap \text{conv}(\mathcal{G}_a^-(V) \setminus \mathcal{G}_a^-(W'_1)) \neq \emptyset.$$

(ii) The set  $W_6 := \{v_1, v_3, v_4, v_6\}$  is a 2-face of  $P$ , as

$$\text{rint}(\text{conv}(\mathcal{G}_a^+(V) \setminus \mathcal{G}_a^+(W_6))) \cap \text{rint}(\text{conv}(\mathcal{G}_a^-(V) \setminus \mathcal{G}_a^-(W_6))) \neq \emptyset.$$

We now give the translation of Theorem 2.14.14 to affine Gale diagrams

**Theorem 2.14.25**<sup>17</sup> *A sequence  $\mathcal{G}_a(V) := (\mathcal{G}_a(v_1), \dots, \mathcal{G}_a(v_n))$  of points in  $\mathbb{R}^{n-d-2}$  is an affine Gale diagram of a  $d$ -polytope (other than a pyramid) with vertex set  $V$  if and only if, for any hyperplane  $H$  spanned by some of the points in  $\mathcal{G}_a(V)$  and for each open halfspace determined by  $H$ , the number of positive points on this halfspace plus the number of negative points on the other open halfspace is at least two.*

Verify this theorem with the affine Gale diagram in Fig. 2.14.4.

Theorems 2.14.23 and 2.14.25 are stated for a polytope  $P$  with no special points. This is not a limitation, since adding  $k$  special points amounts to taking a  $k$ -fold pyramid  $Q$  over  $P$ , and the combinatorics of  $Q$  is determined by that of  $P$  and the number  $k$ .

## 2.15 Problems

**2.15.1** Let  $P$  and  $Q$  be polytopes in  $\mathbb{R}^d$ , let  $\alpha \in \mathbb{R}$ , and let  $K$  be an affine subspace of  $\mathbb{R}^d$ . Prove that  $P + Q$ ,  $P \cap Q$ ,  $P \cap K$ , and  $\alpha P$  are all polytopes in  $\mathbb{R}^d$ .

**2.15.2** Let  $P$  be a polytope and let  $F$  be a facet of it. Suppose there are exactly two vertices outside  $F$ . Prove that these vertices must be adjacent.

**2.15.3** Let  $P$  be a  $d$ -polytope,  $F$  an  $h$ -face of  $P$ , and  $F_0$  a proper  $k$ -face of  $F$  with  $-1 \leq k < h \leq d$ . Prove that there exists a  $(d - h + k)$ -face  $F_1$  of  $P$  such that  $F_0 = F_1 \cap F$  and  $P = \text{conv}(F \cup F_1)$ .

<sup>17</sup> A proof is available in Ziegler (1995, thm. 6.1.9).

**2.15.4** Let  $P$  be a  $d$ -polytope,  $F_j$  a  $j$ -face of  $P$ , and  $F_i$  an  $i$ -face of  $P$  such that  $-1 \leq i < j \leq d$ . Prove that the lattice  $\mathcal{L}(F_j/F_i)$  is a sublattice of the lattice  $\mathcal{L}(P)$ .

**2.15.5** Prove that a  $d$ -polytope is a  $d$ -simplex if and only if it has  $d + 1$  facets.

**2.15.6** (Pyramids) Let  $P$  be a  $d$ -polytope. Prove the following.

- (i) If  $P = F * \mathbf{v}$  is a pyramid, then  $F$  is a pyramid with apex  $\mathbf{w} \neq \mathbf{v}$  if and only if  $P$  is a pyramid with apex  $\mathbf{w}$ .
- (ii) A  $d$ -polytope is a pyramid over  $r$  distinct facets if and only if it is an  $r$ -fold pyramid.

**2.15.7** Let  $P$  and  $P'$  be two  $d$ -polytopes with a facet  $F$  of  $P$  projectively isomorphic to a facet  $F'$  of  $P'$ . Prove that there exists a projective transformation  $\zeta$  such that  $\text{conv}(P \cup \zeta(P'))$  is a realisation of  $P \#_F P'$ .

**2.15.8** Prove that a polytope  $P$  is  $k$ -simplicial if and only if  $P^*$  is  $k$ -simple.

**2.15.9** (McMullen, 1976) Prove that the connected sum of two polytopes along simplex facets is always possible. This amounts to proving that a simplex is projectively isomorphic to any other realisation of a simplex.

**2.15.10** Prove that if we stack over a facet  $F$  of a polytope  $P$ , then the conjugate vertex of  $F$  in the dual polytope  $P^*$  of  $P$  gets truncated, and vice versa.

**2.15.11** Prove that if we perform the wedge of a polytope  $P$  at a facet  $F$  of it, then we are performing the dual wedge of the dual polytope  $P^*$  at the conjugate vertex of  $F$  in  $P^*$ , and vice versa.

**2.15.12** (Ewald and Shephard, 1974) A polytope can be made simple by truncating the vertices, then the original edges, and so on up to the ridges of the polytope.

**2.15.13** Consider the simplicial  $(d - r)$ -polytope  $F_r := T(1) \oplus T(d - r - 1)$ , and the  $r$ -fold pyramids  $\text{pyr}_r(F_r)$ , for  $r \in [0 \dots d - 2]$ . Prove that the  $f$ -vectors of the  $d$ -polytopes  $T(d)$  and  $\text{pyr}_r(F_r)$  (for  $r \in [0 \dots d - 2]$ ) form an affinely independent set in  $\mathbb{R}^d$ .

**2.15.14** Prove that the  $f$ -vectors of the following sets of simplicial  $d$ -polytopes form a set of affinely independent vectors in  $\mathbb{R}^d$ .

- (i) The  $d$ -simplex and the  $\lfloor d/2 \rfloor$  simplicial  $d$ -polytopes  $T(r) \oplus T(s)$  with  $r, s \geq 1$  and  $r + s = d$ .
- (ii) The cyclic  $d$ -polytopes  $C(n, d), C(n + 1, d), \dots, C(n + \lfloor d/2 \rfloor, d)$  with  $n \geq d + 1$ .

**2.15.15** (Cuboids; Grünbaum, 2003, sec. 4.6) The cuboid  $Q(d, 0)$  is combinatorially isomorphic to the  $d$ -cube  $Q(d)$ . For  $r \in [0 \dots d]$ , the cuboid  $Q(d, r)$  is obtained by ‘pasting together’ two cuboids  $Q(d, k - 1)$  along a common cuboid  $Q(d - 1, k - 1)$ . This operation requires that the two cuboids  $Q(d, k - 1)$  are deformed beforehand. Prove the following.

- (i)  $f_k(Q(d, 0)) = 2^{d-1} \binom{d}{k}$ .
- (ii)  $f_k(Q(d, r)) = 2f_k(Q(d, r - 1)) - f_k(Q(d - 1, r - 1))$ , for  $k \in [0 \dots d - 1 - r]$ .
- (iii) For  $k, r \geq 0$  and  $k \in [0 \dots d - 1 - r]$ , it holds that

$$f_k(Q(d, r)) = \sum_{i=0}^r \binom{r}{i} \binom{d-i}{k} 2^{d+r-k-2i}.$$

**2.15.16** Prove that the cubical  $d$ -polytopes  $Q(d, 0), \dots, Q(d, \lfloor d/2 \rfloor)$  defined in Problem 2.15.15 form a set of affinely independent vectors in  $\mathbb{R}^d$ .

**2.15.17** Let  $P$  be a  $d$ -polytope in  $\mathbb{R}^d$  and let  $\mathcal{G}$  be a Gale diagram of  $P$ . Prove that if  $v$  is a vertex of  $P$ , then  $\mathcal{G} \setminus \{\mathcal{G}(v)\}$  is a Gale diagram, but not necessarily the Gale transform, of the vertex figure  $P/v$  of  $P$  at  $v$ .

**2.15.18** Produce realisations of polytopes combinatorially isomorphic to the polytopes whose Gale diagrams appear in Fig. 2.15.1.

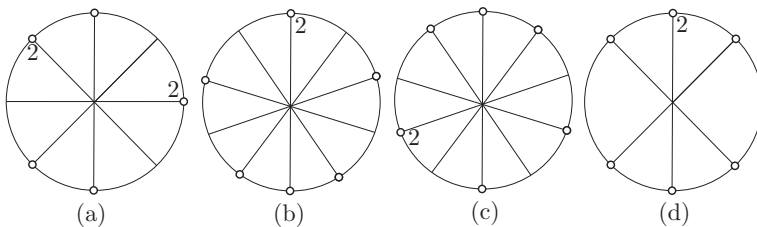

Figure 2.15.1 Gale diagrams of four 4-polytopes with seven vertices; the labels state the number of vectors in the corresponding position.

**2.15.19** (Projectively unique polytopes; McMullen, 1976) A polytope  $P$  is *projectively unique* if every polytope combinatorially isomorphic to  $P$  is projectively isomorphic to  $P$ . Prove the following.

- (i) The  $d$ -simplex is projectively unique.
- (ii) Every  $d$ -polytope with  $d + 2$  vertices is projectively unique.
- (iii) The dual polytope of a projectively unique polytope is also projectively unique.
- (iv) The join of two polytopes  $P_1$  and  $P_2$  is projectively unique if and only if both  $P_1$  and  $P_2$  are projectively unique.

---

**2.15.20\*** (Perfect shellings; Ziegler, 1995, ex. 8.9) Let  $F_1, \dots, F_s$  be a shelling of a polytope. For each  $i \in [1 \dots s]$ , order the  $(d - 2)$ -faces of  $F_i$  as they appear in this list:  $F_1 \cap F_i, F_2 \cap F_i, F_{i-1} \cap F_i, F_{i+1} \cap F_i, \dots, F_s \cap F_i$ . If, for each  $i \in [1 \dots s]$ , this ordering of the  $(d - 2)$ -faces of  $F_i$  is a shelling of  $F_i$ , then we say that the shelling is *perfect*.

- (i) Does every polytope have a perfect shelling?
- (ii) Does every simple polytope have a perfect shelling?
- (iii) Does every cubical polytope have a perfect shelling?

Ziegler attributes the first question to Gil Kalai. It is known that simplicial polytopes, duals of cyclic polytopes,  $d$ -cubes, and 3-polytopes all have perfect shellings.

## 2.16 Postscript

The Representation theorem for cones (2.2.1) resulted from the efforts of Farkas (1898, 1901), Minkowski (1896), and Weyl (1935). It is often proved via Farkas' lemma, as in Schrijver (1986, cor. 7.1a). The representation theorem for polyhedra (2.2.2) is due to Motzkin (1936).

The statements about the facial structure of polyhedra (Theorem 2.3.1) and, more generally, those in Section 2.3, are standard and scattered across many texts on convexity; for instance see Webster (1994, sec. 3.2), Brøndsted (1983, sec. 2.8), and Lauritzen (2013, ch. 4). Our proofs, while standard, were inspired by the presentation in Webster (1994, sec. 3.2) and Brøndsted (1983, sec. 2.8). The proof of Proposition 2.3.2 follows the same ideas as that of the second part of the proof of Lauritzen (2013, prop. 4.3). The proof for the sufficiency part

of the characterisation of faces of polytopes in Theorem 2.3.7 is inspired by ideas from the proof of Webster (1994, thm. 3.1.4).

The section on preprocessing has the spirit of Ziegler (1995, sec. 2.6), while trying to have the appeal and concreteness of Yaglom (1973); consult Ziegler (1995, sec. 2.6) for the formulas that we did not provide. The presentation of the embedding of affine spaces into projective spaces follow that in Berger (2009, ch. 5) and Gallier (2011, sec. 5.6).

Sections 2.7 on face figures and 2.8 on simple and simplicial polytopes are based on the excellent accounts of Brøndsted (1983, sec. 2.11–2.12). The proof by duality of Theorem 2.11.9 is based on the proof by Brøndsted (1983, thm. 2.11.10), while the proof that, for  $d \geq 3$ , a  $d$ -simplex is the only simple and simplicial polytope (Theorem 2.8.8) is inspired by that of Brøndsted (1983, thm. 2.11.19).

The material of Section 2.9 on cyclic and neighbourly polytopes is fairly standard. Our presentation is similar to those in Grünbaum (2003, sec. 4.7,7.1), Webster (1994, sec. 3.4), and Brøndsted (1983, sec. 2.13).

The proof of the inductive construction of polytopes offered in Theorem 2.10.1 is based on the original proof of Grünbaum (1963, thm. 5.2.1). As we stated after the proof of Theorem 2.10.1, the original proof of Grünbaum (1963, thm. 5.2.1) is slightly incorrect. The same mistake is carried over in the proof of McMullen and Shephard (1971, thm. 2.22). This mistake was first noted by M. A. Perles, as acknowledged by Altshuler and Shemer (1984). This inductive construction is often described as the *beneath-beyond* algorithm and plays an important role in the computation of convex hulls in computational geometry; see, for instance, Edelsbrunner (2012, sec. 8.4) and Preparata and Shamos (1985, sec. 3.4.2).

In many settings, the operations of pulling and pushing vertices allow us to focus on simplicial polytopes. This is the case with the upper bound theorem of McMullen (1970), which states that the cyclic  $d$ -polytope on  $n$  vertices has the largest number of faces among the  $d$ -polytopes with that number of vertices. The process of pulling vertices first appeared in Eggleston et al. (1964, sec. 2), while the process of pushing vertices was first announced in Klee (1964b, sec. 2). Our proof of Theorem 2.10.5 is based on that of Matoušek (2002, lem. 5.5.4) and Santos (2012, lem. 2.2).

The presentation of polytopal complexes, subdivisions, and Schlegel diagrams is similar to that of Ziegler (1995, sec. 5.1,5.2). Schlegel diagrams first appeared in Schlegel (1883), but Sommerville (1958) seems to be the first to exploit their use on polytopes. Lee (1991) showed that the regularity of a subdivision of a polytope  $\text{conv } V$  can be tested via the Gale transform of the set  $V$ . We did not go into algorithmic aspects of subdivisions; they are well

covered in De Loera et al. (2010, sec. 8.2). We just remark that checking whether a subdivision is regular is equivalent to the feasibility of a linear program (De Loera et al., 2010, sec. 8.2).

Proposition 2.12.12 states that stars of vertices of shellable complexes are shellable. This is due to Courdurier (2006), and our proof follows his. It is also the case that links of vertices in shellable polytopal complexes are shellable (Courdurier, 2006); this generalises Proposition 2.12.11, which gives that links of vertices in boundary complexes of polytopes are shellable.

Our proof of Euler–Poincaré–Schläfli’s equation (Theorem 2.12.17) is inspired by that of Gruber (2007, thm. 15.5). The proof of Dehn–Sommerville’s equations is somehow standard: it relies on the generalisation of Euler–Poincaré–Schläfli’s equation stated in Theorem 2.13.1; see, for instance, Webster (1994, thm. 3.5.4) or McMullen and Shephard (1971, thm. 2.4.19). The derivation of the  $h$ -vector of simplicial polytopes from shellings is explained in more detail in Ziegler (1995, sec. 8.3); our description aims to summarise his. Dehn–Sommerville’s equations for cubical polytopes seem to have first appeared in Grünbaum (2003, thm. 9.4.1).

The section on Gale transforms (Section 2.14) is based on the presentations in McMullen and Shephard (1971, ch. 3) and Webster (1994, sec. 3.6).