

Antigenic modulation of *Bordetella pertussis*

By B. W. LACEY

The Department of Bacteriology, Westminster Medical School, London, S.W. 1

(Received 4 April 1959)

INTRODUCTION

While developing a selective medium for *Bordetella pertussis* (Lacey, 1954) it was found that a crude rabbit serum against *B. parapertussis*, which agglutinated *B. pertussis* on the slide to a titre of 800, failed, even at a titre of 2, to agglutinate the same strain of *B. pertussis* grown on Bordet–Gengou medium containing magnesium sulphate in place of sodium chloride. This difference was over a hundred times greater than that often observed between growths of the same strain of bacterium from different environments. Preliminary experiments showed that the change was not the result of mutation and selection, for it occurred simultaneously in a whole population, was regularly reproducible, not accompanied by roughness, completely reversible within one subculture and shown by all freshly isolated strains. It thus resembled the lack of capsule formation by virulent strains of *Pasteurella pestis* during growth at 26° C. (Schütze, 1932) and was quite different from the relatively stable, unpredictable, and almost certainly mutational phase variation of *B. pertussis* described by Leslie & Gardner (1931). An investigation of this antigenic change is recorded here. It was prompted in part by its immediate importance for identification and classification of *Haemophilus* and *Bordetella* species and in part by its obvious potential importance for the production of effective vaccines. But it was undertaken chiefly for its intrinsic interest and with a view to clarifying the well known, but hitherto obscure and unpredictable, variability of *B. pertussis*. Some of the results have been briefly reported already (Lacey, 1951, 1953*a, b*).

There is no generally accepted term for a 'change of phenotype occurring in all, or almost all, members of a population as the expression of a reversible and continuously-environmentally-dependent change in metabolism', comparable with the term *mutation* for a 'spontaneous or partially environmentally precipitated more or less irreversible change of potentiality, occurring not more often than once in a hundred cell divisions'. Dobell (1912), Eisenberg (1912), and others, who first clearly distinguished these two kinds of variation in bacteria, favoured the word *modification*. But although this word has been widely used in biology, and much recently for the more or less reversible changes induced in plants by growth substances, its use in microbiology in this sense is somewhat objectionable because of the frequent need to employ it, in the same sentence or paragraph, to mean a physical or chemical change directly produced in (*a*) living cells without participation of microbial metabolism, or (*b*) dead cells, or (*c*) extracellular virus (see Magill & Sugg, 1948; Briody, 1948; le Bouvier, 1955). The lack of precision in *modification*

is well shown by its use at one time for change in heterogeneous populations resulting from selective pressure (Cole & Wright, 1916), and recently (Hilleman, 1954) to cover all observed changes of phenotype of influenza viruses, whether at root these result from mutation, recombination, or change (host induced) of the kind under consideration. The vagueness of *modification* is not removed by qualification. Thus *antigenic modification* could well be used for sensitization of an antigen by an antibody and this expression has been applied to changes in red blood cells (a) produced *in vitro* by viruses or trypsin (Wallace, Dodd & Wright, 1955) or bacterial substances (Neter, Westphal, Lüderitz, Gorzynski & Eichenberger, 1955), (b) found *in vivo* in leukaemia (Calaresu, Spurrier & Schwartz, 1956), and (c) produced *in vivo* by gene interaction (Weiner, Lewis, Moores, Sanger & Race, 1957).

Other expressions are even less precise. *Impressed variation* (Winslow & Walker, 1909), *adaptive modification* (Jordan, 1915; Burnet, 1953), *physiologic variation* (Stanier, 1953) and *physiological adaptation* (Stanier, 1953) do not exclude selection of mutants and may explicitly include variation from heterocariosis. *Fluctuation* (Cole & Wright, 1916; Arkwright, 1930) has been used for rare, stable mutation (Toenniessen, 1915), is now associated with Luria & Delbrück's (1943) test for detecting and estimating spontaneous mutation, and like *temporary variation* (Arkwright, 1930; Jones, 1954; Spiegelman & Landman, 1954) or *temporary modification* (Braun, Kraft, Mead & Goodlow, 1952) might reasonably be taken to include phase change of flagella or the *periodic selection* described by Atwood, Schneider & Ryan (1951). *Fluctuating variation* was used by Winslow & Walker (1909) for variation resulting from inequalities of cell division. *Phenotypic variation* (Wilson & Miles, 1955), *phenotypic modification* (Wilson & Miles, 1955), *phenomic accommodation* (Stanier, 1953), *phenotypic adaptation* (Shepherd, 1957) and *phenotypization* logically include all manifest variation from any cause and Westergaard (1957) nicely uses the first expression with this sense. Even *non-heritable variation* (Cole & Wright, 1916; Ravin, 1953) is too broad because it includes (a) *phenocopies*, i.e. irreversible, non-transmissible, environmentally-induced changes mimicking heritable changes (Goldschmidt, 1938; Landauer, 1948), and (b) changes resulting directly from physical or chemical action (modifications). *Pleomorphism* or *dimorphism*, although much used in mycology and botany, are too limited to visible change and liable to be confused with *polymorphism* or *morphism* which have a restricted meaning in genetics (Huxley, 1955).

In review, the most precise and useful word seems to be *modulation*. It was introduced by Weiss (Bloom, 1937) to denote reversible changes of appearance and behaviour shown by tissue cells under different environmental conditions. It has since been used with much the same sense for changes in metazoon cells by Weiss (1939, 1947, 1949, 1953), Waddington (1948) and Fell (1954), for enzymic adaptation (induced enzyme activity) in bacteria by Monod (1947) and Waddington (1953) and in a somewhat similar sense by Mellon & Hagan (1942) and Hinshelwood (1957). Schmitt (1956) has employed it recently for the effects of specific substances on the reversible interaction of DNA and protein macromolecules, Zuckerman (1957) for environmentally induced changes in pituitary and re-

productive activity, and Brodie & Hogben (1957) for the reversible action of drugs on enzyme systems. It has a great advantage over all the other expressions of allowing the use, without ambiguity, of single words such as *modulate* (in either an active or passive sense), *modulatable*, *modulatability*, *modulator* and *mode*, corresponding to mutate, mutable, mutability, mutagen and mutant. In this paper therefore modulation will be used to mean the change defined in the first sentence of the second paragraph above, and the distinct phenotypes (of the same genotype) will be called *modes*.

In retrospect it seems certain that modulational changes of *B. pertussis* were first observed by Bordet & Sleswyk (1910), even though Bordet (1912) himself later confused them with changes of mutational origin. As differences of agglutinability on different media they have also been noted on several occasions (Povitzky & Worth, 1916; Krumwiede, Mishulow & Oldenbusch, 1923; Cruickshank & Freeman, 1937; Andersen, 1952).

MATERIALS AND METHODS

Glassware and containers

Traces of tellurite, fatty acids and detergents are liable to inhibit growth of *B. pertussis* or produce marked changes in the antigenic structure of the kind under investigation. Therefore stainless steel Petri dishes, or glass dishes kept exclusively for this work, have been used and all containers have been cleaned with the aid only of soda and hydrochloric acid and rinsed for several hours in distilled water.

Experimental medium

As a more reproducible medium than Bordet–Gengou, one which grows *B. pertussis* almost as well, and in which the salts and amino acids could be varied easily, the following was used:

Base. New Zealand agar (Davis Gelatine Co. Ltd.) 14 g.; potato starch (British Drug Houses) 15 g.; glycerol (AR; Hopkin and Williams) 5 ml.; DL-alpha alanine (British Drug Houses) 1 g.; tap water to 1000 ml.; adjusted to pH 7.2; autoclaved in 22 ml. amounts in 60 ml. flat screw-capped bottles at 110° C. for 10 min. At times 7.5 g. Difco proteose peptone/l. were included in the base to increase the amount of growth.

Glutamate solution. L-Glutamic acid (Hopkin and Williams) 40 g.; distilled water to 180 ml.; adjusted to pH 7.2 with 20% (w/v) sodium hydroxide (AR; Hopkin and Williams); distilled water to 300 ml.; autoclaved at 110° C. for 10 min.

Cysteine solution. L- or DL-cysteine hydrochloride (Hopkin and Williams) 5 g.; distilled water to 100 ml.; brought to boil for 3 min.; stored at 5° C. for up to 7 days; neutralized not more than 5 min. before use with one-fifth volume of 10% (w/v) potassium hydroxide (AR; Hopkin and Williams).

Salt solutions. All were made as near as possible 0.72 N in distilled water.

Preparation of plates. To 22 ml. base, melted and cooled to 45° C. were added: 1 ml. glutamate solution, 4 ml. (unless otherwise stated) of a chosen salt solution or mixture of salt solutions (to give a final concentration of about 0.085 N);

0.5 ml. neutralized cysteine solution, and 10 ml. of defibrinated horse blood less than 7 days old, well shaken and left to reach room temperature beforehand. The whole amount (37.5 ml.) was used for one plate.

Abbreviations. The exact composition of any medium is indicated in this paper by adding the anhydrous chemical formulae of the salts included after the letters EM (or EMP if made with the peptone containing base) and a number for the volume in ml. of each salt solution. Thus 'EM MgSO₄ 0.8 NaCl 3.2' denotes a medium made by adding 0.8 ml. of 0.72 N magnesium sulphate and 3.2 ml. of 0.72 N sodium chloride to 33.5 ml. of base, glutamate solution, cysteine solution and blood.

Strains

Most experiments have been made with two normal, fully smooth, undegraded strains of *B. pertussis*. They were chosen for their contrasting agglutinability by a serum (5/50) against a strain (PA1) of *B. parapertussis* grown on Bordet-Gengou. The origin and some of the characters of all the strains used are listed in Table 1. A reference cellar of all strains has been kept dried by Stamp's (1947) method or

Table 1. *Origin and character of strains: all isolated from humans*

Westminster no.	Bacterium	Source	Slide-agglutination titres* with 60 hr. growth on Bordet-Gengou at 35° C.			
			<i>B. para.</i> (PA 1) serum (4/50)	Andersen's factor sera		
				a ₂	a ₃	a ₄
H 5	<i>B. pertussis</i>	Westminster Hospital	1,280	160	0	80
H 15	<i>B. pertussis</i>	Westminster Hospital	160	0	320	0
H 18	<i>B. pertussis</i>	Westminster Hospital	1,280	160	0	40
H 19	<i>B. pertussis</i>	Westminster Hospital	320	0	160	0
H 31	<i>B. pertussis</i>	Westminster Hospital	640	40	80	20
H 35	<i>B. pertussis</i>	Westminster Hospital	1,280	80	0	40
H 36	<i>B. pertussis</i>	Westminster Hospital	160	0	160	0
H 40	<i>B. pertussis</i>	Kendrick's 18,323	1,280	160	40	40
H 5M	<i>B. pertussis</i>	Mutant of H 5	10	0	0	0
H 6	<i>B. pertussis</i>	Presumed mutant of 18,323, from A. F. B. Standfast's E 5, from H. Proom's CN. 16262, from G. Eldering, from P. Kendrick's 18,323	0	0	0	0
H 41	<i>B. pertussis</i>	Kendrick's 25L4	0	0	0	0
PA 1	<i>B. para- pertussis</i>	A. J. H. Tomlinson	20,480	0	0	0
PA 15	<i>B. para- pertussis</i>	Westminster Hospital	20,480	0	0	0
BR 4	<i>B. bronchi- septica</i>	N.C.T.C. 8762	10,240	0	0	0

* 0: < 2

in glucose-serum-broth from the frozen state. Because of the steady production of degraded mutants from freshly isolated strains a single colony isolate of the predominant type has been used for preparing new inocula from the dried cultures.

Incubation

The temperature has been controlled with NPL-tested thermometers and kept within 0.1°C . in water-jacketed incubators. The humidity has been kept high with a tray of water. The incubator has been kept shut for at least 14 hr. before removal of plates and all growths have been harvested within 10 min. of removal.

Sera

Each $3\frac{1}{2}$ in. Petri dish was inoculated with about 5×10^7 colony-producing units in a loopful of digest broth. When about half maximum, the growth was harvested with an angled glass rod into N/400 hydrochloric acid, suspended by shaking by hand for about 2 min. and preserved (unless otherwise stated) by adding fresh 4% formal saline to give a final concentration of 0.2% formalin. Suspensions have been adjusted to pH 7.0 with sodium bicarbonate, allowed to sediment overnight, decanted, diluted to an opacity equal to Brown's tube no. 9 (Burroughs Wellcome) (equivalent to 36 provisional international units) and stored at 5°C . Unless otherwise stated, animals have been given six intravenous injections at 7-day intervals of 0.25, 0.5, 1.0, 1.0, 1.0 and 1.0 ml. vaccine in 5 ml. saline. This short method was chosen in order to get as sharp a reflexion of the antigenic structure as possible with workable titres. When, however, a high titre of heterologous antibody has been wanted (as with *B. parapertussis* PA 1 BG serum 5/50) two further courses have been given. Only six of some 120 animals were rejected for having antibodies before inoculation: all against growth on EM NaCl 4.0 at 35°C . and all from stock known or found to be infected with *B. bronchiseptica*. Animals were bled between the seventh and tenth days after the last inoculation and resulting sera preserved at 5°C . after addition of $\frac{1}{5000}$ thiomersalate. Absorptions have been made with living cells and undiluted serum for 10 min. at room temperature. Unless otherwise stated, only sufficient growth has been used to reduce the slide-agglutinin titre to less than 2.5 against the absorbing organism. In this paper the minus sign has been used for absorption. Thus X-C denotes an X-mode serum absorbed by a C-mode suspension. Sera specific for antigen factors 2, 3 and 4 (Andersen, 1953) were kindly supplied by Dr Else Kragh Andersen.

Agglutinin titrations

Suspensions have been made in the same way as for vaccines but to a final opacity equal to Brown's tube no. 7 (equivalent to 28 provisional international units). They were kept at 5°C . and used within 72 hr. Doubling dilutions of serum were made in $2\frac{1}{2}$ in. \times $\frac{3}{8}$ in. tubes in $\frac{1}{5000}$ thiomersalate in 0.85% (w/v) NaCl. Titrations were made at room temperature on Murray (1944) slides with twelve platforms. A 0.02 ml. drop of suspension was added to the same volume of diluted serum and the slide rocked intermittently for 20 min. Results were read with the naked eye and oblique illumination. The sensitivity of this method is from a half

to one-quarter that of a tube rocked continuously for 2 hr. (Miller & Silverberg, 1939), but it is equally reproducible, quicker and economic enough to allow the use of a final serum dilution of 1 in 5.

Haemagglutinin titrations

Sheep red cells, preserved with 0.25% (v/v) formalin (Burroughs Wellcome) were washed three times in 0.85% (w/v) saline and a 1% (v/v) suspension of loosely packed cells made in thiomersalate saline. Growth was suspended in thiomersalate saline to make an opacity equal to twice that of Brown's tube no. 9 and serial twofold dilutions made in thiomersalate saline in $2\frac{1}{2}$ in. \times $\frac{3}{8}$ in. tubes. Suspensions were titrated, within 20 min. of preparation, at room temperature, on Murray slides, with the same volumes and method used for agglutinin titrations.

Aluminium phosphate precipitability

The original technique of Ungar & Muggleton (1949) was used except that growths were not washed before formalinization.

Heavy metal agglutinability

A loopful of growth was suspended in 0.85% (w/v) saline to make an opacity equal to Brown's tube no. 7 and 4% formal saline (standing over magnesium carbonate) added to give a final concentration of 0.2% formalin. If necessary, the reaction was adjusted to pH 6.5 with dilute hydrochloric acid or sodium hydroxide. After 1–2 hr. at room temperature, the agglutinability by mercuric chloride (HgCl_2 (AR, BDH)) or gold sodium chloride ($\text{NaAuCl}_4 \cdot 2\text{H}_2\text{O}$) was tested on Murray slides, using serial twofold dilutions of the metal salts in distilled water and 0.02 ml. volumes as for agglutinin titrations. Results were read at 10 min.

Conductances

Equivalent conductances of salts, for which no published values could be found, were determined at room temperature with a Mullard conductivity bridge (type E. 7566) and a dip cell with blacked platinum electrodes (type E. 7591B).

ABBREVIATIONS AND TERMINOLOGY

Antigenic mode: the set of antigenic states with the same predominant major antigens.

Antigenic state: one of an infinite number of unique antigenic structures interchangeable by modulation.

C mode: cyanic mode; mode of growth of *Bordetella* species at lower temperatures, etc.

Centre of inertia*: point where second moments balance.

Conductance ratio*: ratio of equivalent conductance under conditions of experiment to equivalent conductance at infinite dilution at the same temperature.

* Usual scientific meaning.

Effective concentration: product of equivalent concentration and conductance ratio.

EM(P): experimental medium (with peptone).

Equilibrium: time when rate of change of antigenic state is negligible.

Equivalent conductance*: conductance of an equivalent weight of salt between plates 1 cm. apart.

Equivalent modulating power (of a salt): ratio of milli-equivalents of sodium chloride to milli-equivalents of salt having an equivalent modulating influence at 34.8° C.

I mode: intermediate mode; mode of growth of *B. pertussis* under conditions intermediate between those leading to X and C modes.

Inflexion state: antigenic state with character of two modes in equal measure.

Major: fully antigenic, agglutinable and absorbing.

Minimal: fully antigenic, but neither agglutinable nor absorbing.

Minor: fully antigenic and absorbing, but not agglutinable.

Mode: one of a repertoire of phenotypes interchangeable by modulation.

Modulation: change of phenotype occurring in all, or almost all, members of a population as the expression of a reversible and continuously-environmentally-dependent change of metabolism.

mS: measure in arbitrary units of the modulating influence of a salt or mixture of salts; position of a salt, or centre of inertia or a mixture, on the centre line of Fig. 1, or mS line of Figs. 9 and 12.

mT: measure of the modulating influence of temperature in mS units.

m(TS): measure of the combined modulating influence of salts and temperature in mS units.

Neutral: tending to induce growth of *B. pertussis* in the inflexion state between X and I modes.

Specific modulating power (of a salt): ratio of the effective concentration of sodium chloride to the effective concentration of the salt that is neutral at 34.8° C.

X mode: xanthic mode: mode of *Bordetella* species at higher temperatures, etc.

RESULTS AND DISCUSSION

Preliminary survey of the two extreme antigenic forms (modes) of Bordetella pertussis

The two extreme antigenic forms of *B. pertussis* H5 are readily reproduced by incubating, at 35° C., an inoculum from any medium on two media: one with sodium chloride as the chief salt present, the other with magnesium sulphate as the chief salt present. Some properties of the two forms of strain H5 are compared in Table 2.

All features of the sodium chloride medium growth (EM NaCl 4.0, 35° C. growth) are shown by growth at 35° C., on medium containing potassium bromide instead of sodium chloride, i.e. EM KBr 4.0, 35° C. growth. Similarly, the character of EM Na₂SO₄ 4.0, 35° C. growth is indistinguishable from EM MgSO₄ 4.0, 35° C.

* Usual scientific meaning.

Table 2. *Comparisons of the two extreme growth forms (modes) of Bordetella pertussis strain H 5 grown at 35° C. for 88 hr.*

Medium of growth	EM NaCl 4.0	EM MgSO ₄ 4.0
Colonies	1.2 mm. diameter, convex, pale ochre, glossy, slightly glutinous, suspend with 30 sec. shaking	1.5 mm. diameter, low convex, off white, glossy, butyrous, suspend with 5 sec. shaking
Zone of haemolysis	0.5 mm.	Nil
Colour of confluent growth	Ochre	Pale greenish blue
Odour	Ammoniacal	More aromatic
Viability of confluent growth at 18° C.	c. 60 days	c. 14 days
Cells	Gram - ve, coccoid, non-motile, non-flagellated	Gram - ve, coccobacillary, non-motile, non-flagellated
Saline suspensions	Show no swirl; stable	Show obvious swirl; stable
Minimal agglutinating concentration (% w/v)		
Gold chloride	0.002	0.1
Mercuric chloride	0.002	2.0
Autolysis in 0.85 % (w/v) sodium chloride at 37° C. and pH 8.0	Hours to days	Minutes to hours
Aluminium phosphate precipitability	100 %	90-100 %
Haemagglutinin titre	64	< 2
Agglutinin titres of sera:		
<i>B. parapertussis</i> grown BG at 35° C.	1280	< 2.5
<i>B. bronchiseptica</i> grown BG at 35° C.	2560	< 2.5
Normal rabbits	6 of 120 > 5	All of 120 < 2.5
LD ₅₀ mice		
Intraperitoneally	c. 2 × 10 ⁸	c. 2 × 10 ⁹
Intranasally	c. 10 ⁷	c. 10 ¹⁰
Suggested name	X mode	C mode

growth. Names are thus necessary for these two forms which are independent of the circumstances of their production. 'X mode' (X for xanthic) and 'C mode' (C for cyanic) are proposed, and will be used in this paper, because on media rich in blood the difference in colour of confluent growths is usually apparent.

There can be no doubt that this modal change does not represent a peculiar variation of phase of the Leslie & Gardner kind for it is reproducible and reversible at will and has been shown by every one of over 2000 strains isolated in this laboratory. Equally well, it is not the result of a modifying effect of the salts on the bacterial suspensions or on the antigen-antibody reaction itself since mere

suspension for 96 hr. or titration in salt solutions (of a strength which would certainly induce a reversal of mode under conditions of growth at 35° C.) has a negligible effect on the agglutination titres.

Table 3. Influence of mode of inoculum and medium of growth on the viable count of *Bordetella pertussis*

Batch no. of medium	Number of colonies from twelve separate drops of suspension (six on each of two half plates of medium) after incubation at 35° C. for 88 hr.					
	Inoculum from EM NaCl 4·0			Inoculum from EM MgSO ₄ 4·0		
	Strain	Count on EM NaCl 4·0	Count on EM MgSO ₄ 4·0	Strain	Count on EM NaCl 4·0	Count on EM MgSO ₄ 4·0
1	H 5	198	188	H 15	131	122
2	H 15	165	165	H 5	128	114
3	H 5	120	118	H 15	127	125
4	H 15	190	190	H 5	151	133
5	H 5	121	119	H 15	161	165
Totals		794	780		698	659
		Total colonies	%			
	On EM NaCl 4·0	1492	100	} <i>t</i> (% difference) = 2·478, <i>P</i> < 0·05		
	On EM MgSO ₄ 4·0	1439	96			

Provided the inoculum is not so dense, or the medium so shallow, that fewer than seven cell-divisions are possible, the change from one mode to another is complete within one subculture. By alternate subculture at 35° C. on EM NaCl 4·0 and EM MgSO₄ 4·0, strains H 5 and H 15 have been taken through seven complete cycles of modulation (from X mode to C mode and back to X mode) without change in behaviour. The same strains, maintained in parallel in one mode only (on the same medium) for fourteen subcultures, still modulated when transferred to the other medium as quickly and as fully as the cultures taken through the seven cycles of modulation. Such a complete reversibility made it improbable that mutation and selection were involved, but the possibility was tested by making viable counts from each medium on each medium. The results (Table 3) virtually exclude selection, even though they show that the viability of *B. pertussis* in either mode was slightly, but significantly, less on the medium containing magnesium sulphate.

Several factors other than ionic composition of the medium have been found to influence the mode of growth. Growth in C mode is favoured by lower temperatures, tellurite, fatty acids and, in comparison with normal, fresh horse blood, by old, heated, icteric or guinea-pig blood. Agar, alanine, glycine, glycerol, CO₂, oxygen, peptone, starch, urea and water appear neutral at 35° C. No evidence has been found of any acting by a basically different mechanism or leading to a different end result. In other words, it seems likely that the same mode may be induced by different environments. Thus, for example, C-mode growths which are indistinguishable can be induced by (a) lowering the temperature of growth, or (b) sub-

stituting magnesium sulphate for sodium chloride, or (c) adding sodium pelargonate to about 0.0004 N (c. 80 $\mu\text{g./ml.}$), or (d) by a combination of two or more such changes when none alone is sufficient. Apart from the influence of salts, only that of temperature is considered in detail in this paper.

Qualitative influence of salts, when predominant, on the antigenic mode of growth of Bordetella pertussis at 35° C.

By replacing the sodium chloride in EM NaCl 4.0 by a chemically equivalent amount of another salt, the influence of over 100 salts at 35° C. has been examined. The mode of growth, and hence influence of the salt, was determined from the slide-agglutination titre of the growth with a *B. parapertussis* serum as shown in

Table 4. *Relation of salt influence and type of growth at 35° C. to agglutinability of Bordetella pertussis H 5*

Slide-agglutination titre of <i>B. parapertussis</i> PA 1 BG 35° C. serum (5/50)	Type of growth	Influence of salt (at 0.8N in EM at 35° C.)
< 10	C mode	Pro-C mode
10 to 160	Intermediate	Near neutral
> 160	X mode	Pro-X mode

Table 5. *Effect of salts included in the medium (EM) on the mode of growth of Bordetella pertussis H 5 at 35° C.*

	Ammonium	Potassium	Sodium	Lithium	Calcium	Magnesium	Strontium
Bromide } Chloride }	X	X	X	X	N	C	C
Iodide	X	X	X	X	—	—	—
Nitrate } Formate }	X	X	X	X	C	C	—
Acetate } Malonate }	X	X	X	N	C	C	—
Succinate } Aconitate }	N	N	N	N	—	C	—
Sulphate } Butyrate } Glutarate }	C	C	C	C	—	C	—

X = X mode; C = C mode; N = near neutral; — = not tested

Table 4. The selected results given in Table 5 clearly showed that both anions and cations played a part. They also provided an indication that the influence of a salt was equal or proportional to the algebraic sum of the influences of its component ions. On this assumption the generalized nomogram shown in Fig. 1 was constructed. This summarized all the results at the time and has since correctly predicted the influence of many other salts.

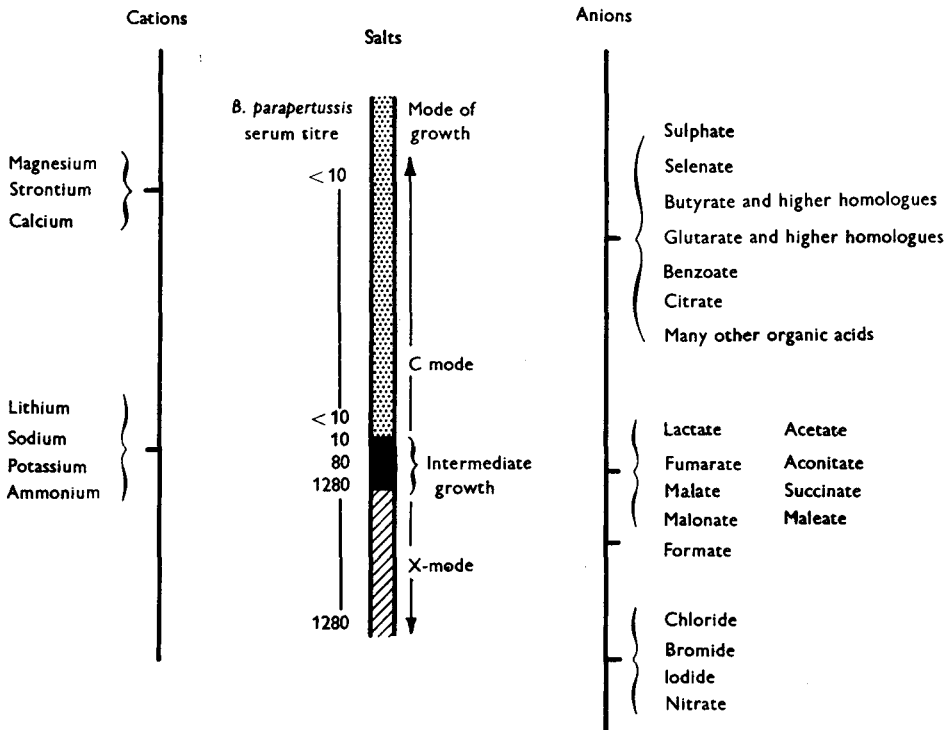

Fig. 1. Relation of antigenic mode of *B. pertussis* H5 when grown at 35° C. for 88 hr. to the salt included in the medium (EM): generalized from the results of Table 7. The mid-point on the line joining two oppositely charged ions represents a salt. The position of this point on the central line indicates the influence of the salt and the mode of growth to be expected.

Effect of mixtures of sodium chloride and magnesium sulphate on agglutinability and haemagglutinating power

Because sodium chloride was clearly pro-X mode and magnesium sulphate clearly pro-C mode it seemed probable that some mixture would be neutral. A series of plates of experimental medium (EM) containing graded mixtures of the two salts was therefore inoculated with a Bordet–Gengou growth of *B. pertussis* H5 and incubated at 35° C. for 88 hr. A suspension from each plate was then examined for haemagglutinating power and agglutinability by (a) unabsorbed *B. parapertussis* PA1 BG serum, (b) unabsorbed *B. pertussis* H5 Em NaCl 4.0, 35° C. serum, and (c) Andersen’s a₂ serum. The results are shown in Fig. 2.

From the parapertussis serum titres and the classification of Table 4 it can be seen that media containing 0.7–0.9 ml. magnesium sulphate were near neutral. The X and C modes were equally well distinguished by the 512-fold difference in their agglutinability by the pertussis serum and, as would be expected, the titre with cells of the mode (X) from which the serum was prepared (homomodal titre) was greater than that with heteromodal (C mode) cells. Fig. 2 also indicates that growth in X mode and development of both haemagglutinin and Andersen’s specific factors are closely associated.

Results strictly comparable with those of Fig. 2 have been observed with all of three other strains tested (H 15, H 35 and H 36).

Comparison of the antibody response to X and C modes

Comparable X- and C-mode growths were made by inoculating 0.1 ml. of a digest broth suspension of an intermediate growth of *B. pertussis* (i.e. from EM MgSO₄ 0.8, NaCl 3.2, at 35° C.) on to plates of EM NaCl 4.0 and EM MgSO₄ 4.0, and harvesting the growths after incubation at 35° C. Apart from the difference in salt content of the two media each serum of a pair (i.e. anti-C mode and anti-X mode) was made and tested in exactly the same way and at the same time. The results obtained in five separate comparisons are given in Table 6. Turkeys were chosen for the fifth comparison because, apart from the rabbit and fowl, no other animal has so far been found to produce useful amounts of antibody to the C mode of *B. pertussis*.

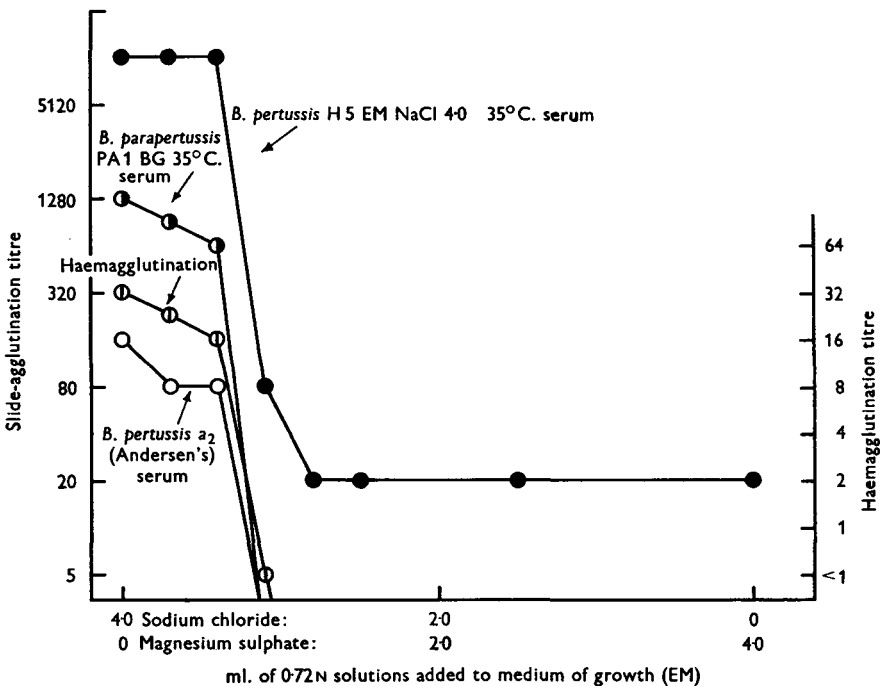

Fig. 2. Influence of salts in the medium of growth (EM) on the agglutinability and haemagglutinating titre of *B. pertussis* H 5 grown at 36° C. for 60 hr.

It can be seen from Table 6 that (i) there is a striking and regularly demonstrable difference in antigenicity between X and C modes, (ii) in all ten sera the homomodal titre exceeded the heteromodal titre, the mean homo:hetero-modal ratios being roughly 16:1 with X-mode sera and 7:1 with C-mode sera, (iii) the ratio of the mean titre induced by X mode against X mode (6124) to the mean titre induced by C mode against X mode (120) is about the same as the ratio of mean titres against *B. parapertussis* (EM NaCl 4.0, 35° C. growth) induced by X mode (460)

Table 6. Comparison of antigenicity of X and C modes of *Bordetella pertussis*

m- son No.	Strain	Animal	Mode of inoculum	Serum no.	Slide-agglutination titres of					
					X-mode sera with suspensions of			C-mode sera with suspensions of		
					<i>B. pertussis</i> *		<i>B. para- pertussis</i> † PA 15 EM NaCl 4.0, 35° C., 48 hr.	<i>B. pertussis</i> *		<i>B. para- pertussis</i> † PA 15 EM NaCl 4.0, 35° C., 48 hr.
					X mode	C mode		X mode	C mode	
1	H 5	Rabbit	X	230/51	10,240	20	160	—	—	—
			C	217/51	—	—	—	80	1,280	10
2	H 15	Rabbit	X	229/51	2,560	160	20	—	—	—
			C	216/51	—	—	—	80	640	< 5
3	H 35	Rabbit	X	44/54	10,240	1,280	1,280	—	—	—
			C	46/54	—	—	—	40	160	< 5
4	H 35	Rabbit	X	161/54	5,120	160	320	—	—	—
			C	163/54	—	—	—	320	640	< 5
5	H 35	Turkey	X	291/54	2,560	320	80	—	—	—
			C	292/54	—	—	—	80	1,280	20
Mean titres:					6,124	388	460‡	120	800	< 10‡

* Same strain and method of preservation as used for serum production.

† Suspension preserved with 0.2% formalin.

‡ Excluding result with strain H 15 because not of Andersen type 2, 4.

and C mode (c. 10) of 2, 4 types of *B. pertussis*. This last suggests that the formation of antigenic substance responsible for inducing agglutinins to *B. parapertussis* is highly associated with, and perhaps inseparable from, the formation of substance inducing agglutinins to the X mode of *B. pertussis*. But it has already been seen (Fig. 2) that the conditions for appearance on the surface of substance agglutinable by *B. parapertussis* serum are the same as those for the appearance of a high-agglutination titre with *B. pertussis* X-mode sera. The agglutinogen on the surface of the X mode may therefore be composed of only one kind of molecule. Both when present on the surface (in X mode) and when, serologically at least, submerged (in C mode) it is referred to in the rest of this paper as the 'X antigen'.

Comparison of the absorbing capacity of X and C modes

The effects of absorbing X-mode, C-mode and intermediate-growth sera of strain H 5 with X- and C-mode cells of the same strain are shown in Fig. 3. Results of absorptions with intermediate growth are not included because growth of this kind removes all antibodies from all sera. Strictly comparable results were obtained with sera and cells of strain H 15. Most unexpectedly, absorptions of intermediate growth sera (and to some extent C-mode sera) with X-mode cells (i.e. EM NaCl 4.0, 35° C., growth) yielded sera specific for intermediate growth. It follows that, under neutral or near neutral conditions, *B. pertussis* develops an agglutinable antigen at the surface (i.e. major antigen or agglutinogen) which is not present in an agglutinable form in either X or C modes. The I minus X serum thus serves as

a reagent for a third mode. For this the name 'Intermediate mode' (or 'I mode') is suggested and used in this paper. Fig. 3 also shows that: (i) C-mode antibodies were removed by both X- and C-mode cells with about the same efficiency, (ii) serum fairly specific for X mode, and closely resembling (as far as *B. pertussis* is concerned) unabsorbed *B. parapertussis* PA1 BG, 35° C., growth serum, resulted

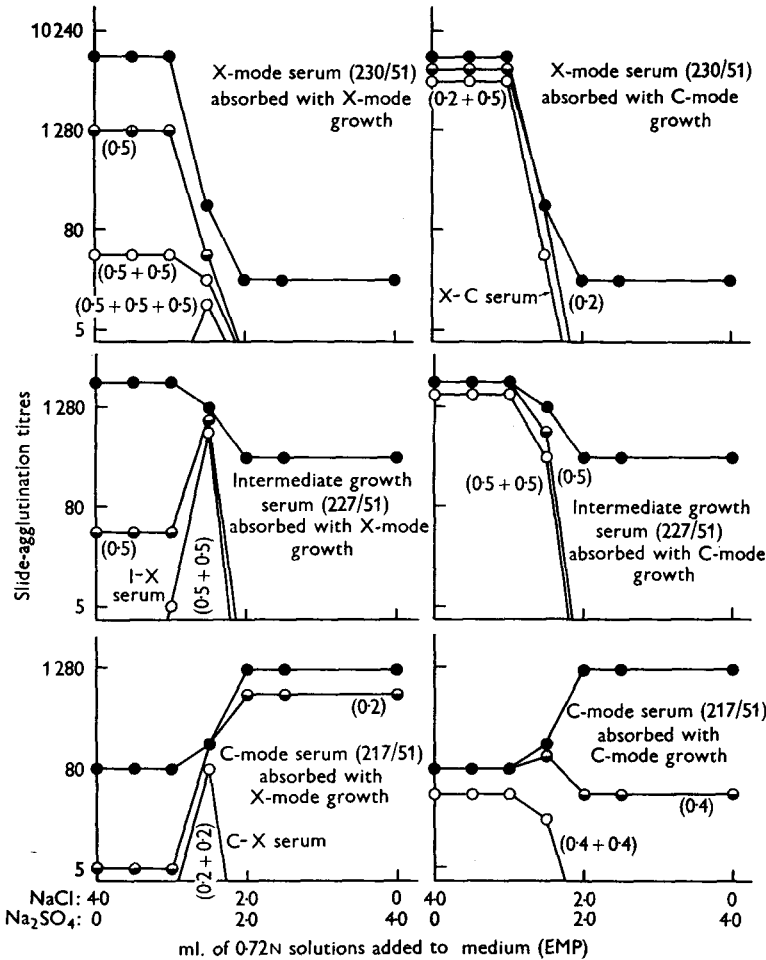

Fig. 3. Comparison of the absorbing capacity of X and C modes of *B. pertussis* with antiserum to each of the three modes. ●, unabsorbed serum; ◐, after first absorption; ○, after second absorption. Figures near lines are approximate volumes of fresh cells added to one volume of serum. All sera, absorptions and titrations were made with strain H 5.

from the absorption of both X- and C-mode sera with C-mode cells, (iii) serum fairly specific for C mode was made by absorbing C-mode serum with a small volume of X-mode cells. The relation of the three modes, and the narrow range of conditions in which the I mode appears, is seen more clearly when the curves of the three absorbed pertussis sera are superimposed as in Figs. 4 and 5. C-mode sera absorbed with X mode (C-X sera) usually agglutinate I mode, have only a low

C-mode agglutinating titre and do not keep well. The three modes are therefore conveniently distinguished on the slide with four sera as shown in Table 7.

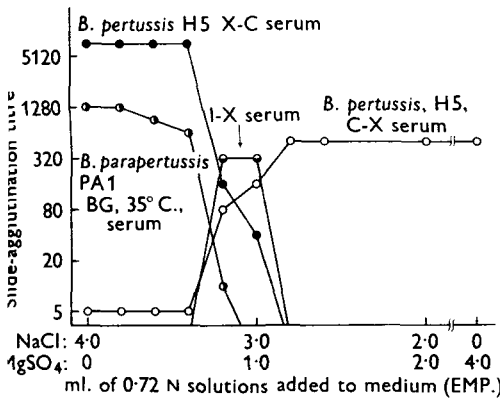

Fig. 4

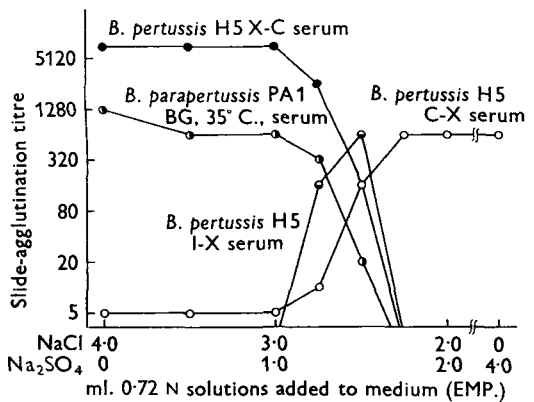

Fig. 5

Fig. 4. Influence of mixtures of magnesium sulphate and sodium chloride in the medium of growth (EMP) on the agglutinability of *B. pertussis* H5 grown at 35° C. for 60 hr.

Fig. 5. Influence of mixtures of sodium sulphate and sodium chloride in the medium of growth (EMP) on the agglutinability of *B. pertussis* H5 grown at 35° C. for 60 hr.

Table 7. Recognition of equilibrium modes of wild-type strains of *Bordetella pertussis* on the slide

Mode	Suspension (<i>B. pertussis</i>) Serotype	Rabbit serum <i>B. paraptussis</i> PA1 grown BG 35° C.	Avian sera		
			<i>B. pertussis</i> I-X (i)	<i>B. pertussis</i> I	<i>B. pertussis</i> I-C
X	With '2' (ii)	+++	0	+++ or ++	+++ or ++
X	Without '2'	+	0	++ or +++	++ or +++
I	Any	0	+++	+ or ++	+ or ++
C	Any	0	0	+ or ++	0

+++ : to titre and with large floccules in 1-2 min.
 ++ : to less than titre but large floccules rapidly.
 + : to much lower titre and with only fine granules at 14 min.
 0 : titre < 5 and no naked eye agglutination at 14 min.
 (i): X suspension of same strain or serotype.
 (ii): Andersen's factor '2'.

From all the results of Fig. 3, and on the assumption that each mode has a specific major antigen (not necessarily the only antigen present at the surface), the agglutinability and absorbing capacities of the three modes have been deduced and are contrasted in Table 8. There are no generally accepted terms to indicate the form or behaviour of antigens in a cell. In this paper *major* is used for an agglutinable antigen and *minor* to denote an antigen which, in a given system,

Table 8. *Agglutinability and absorbing capacities of the three modes of Bordetella pertussis deduced from Fig. 3*

Antibodies	Agglutinability of modes			Absorbing capacity of modes		
	X	I	C	X	I	C
Anti-X antigen	+	0	0	+	+	0
Anti-I antigen	0	+	0	0	+	0
Anti-C antigen	0	?	+	+	+	+

+, present; 0, absent or very slight; ?, uncertain.

Table 9. *Serological behaviour of the three modes of Bordetella pertussis derived from Table 8*

Antigens	Modes		
	X	I	C
X	Major	Minor	Minimal
I	Minimal	Major	Minimal
C	Minor	?	Major

major = agglutinable; minor = absorbing but not agglutinable; minimal = detectable only by antigenicity; ? = not known whether minor or major, certainly not minimal.

absorbs antibody without being agglutinated: i.e. in the sense used by Miles (1939) for antigens of the brucellae. For antigens only demonstrable, in a given system and while in the whole cell, by their antigenicity, the word *minimal* is proposed and will be used here. With this terminology the serological behaviour of the three modes, given in Table 8, has been summarized in Table 9.

Comparison of X, I and C modes as antigens

The X antigen is an unconditionally efficient antigen: X-mode suspensions have induced a homomodal slide-agglutinin titre of 2560 or more by every route and in almost every individual rabbit, guinea pig, rat, mouse, turkey, hen and goose into which they have been injected. The I antigen is moderately effective in both the rabbit and turkey since 6/6 rabbits and 5/5 turkeys inoculated intravenously with thiomersalate- or formalin-preserved I-mode vaccine have produced titres from 320 to 2560. Its antigenicity in other animals has not been tested.

By comparison, the C-mode agglutininogen is a poor antigen. Intraperitoneal inoculation of twenty-four white mice, intracardiac inoculation of six guinea-pigs and three white rats, and intravenous inoculation of one dog, cat, hare and goose (all with five or more doses) has been uniformly unproductive. Of twelve rabbits inoculated intravenously with C mode, four produced homomodal titres of less than 100 and only seven titres over 160; the response appears equally unpredictable in albino, half lop, chinchilla and black. No better route or method than intravenous inoculation has been found: 2/2 rabbits inoculated by Slavin's (1950) alginate method and 1/1 given a subdermal injection of thiomersalate-preserved vaccine 2 weeks before the usual intravenous course, developed titres of 640, but no titre

greater than 100 has been induced by intravenous inoculation of formalin-fixed vaccine given in prolonged courses (3/3 rabbits), massive doses (3/3 rabbits), small daily doses (2/2 rabbits), or of vaccine fixed by alcohol, Susa's, Bouin's or Champy's fluids (1 each), or by formalin-fixed vaccine given intraperitoneally, intramuscularly, subcutaneously or by Freund & Bonanto's (1944) oil and mycobacterium method (one each). Among other animals, only fowls and turkeys have proved responsive to the C-mode antigen: intravenous inoculations have yielded avid titres of 320–2560 in 3/3 hens and 8/8 turkeys. The C-mode antigen thus resembles serum (Hektoen, 1918; Wolfe, 1942), mouse pneumonitis virus (Hilleman & Gordon, 1943) and the meningococcus (Phair, Smith & Root, 1943) in being more consistently and more effectively antigenic for the fowl than the rabbit. In both rabbits and turkeys the C-mode antibodies appear to be maximal about 7 days after a course of five or six inoculations. Thereafter they diminish even if further inoculations are given and when, as a result of the extra inoculations, the X-mode titre is increasing.

Table 10. *Comparison of antigenicity of equilibrium modes of Bordetella pertussis H35 inoculated intravenously in turkeys (1.5×10^{11} organisms in five injections)*

No. of cells inoculated	Cells agglutinated	Serum no.	Agglutinin titres					Means
			260/55	261/55	262/55	263/55	264/55	
X	H 35 X mode		5,120	40,960	10,240	20,480	5,120	16,384
	H 35 I mode		20	2,560	20	320	320	648
	H 35 C mode		10	1,280	10	320	160	356
	PA 15*		40	5,120	20	320	640	828
			Serum no.	256/55	257/55	258/55	259/55	270/55
I	H 35 X mode		2,560	2,560	2,560	2,560	630	2,176
	H 35 I mode		1,280	640	1,280	640	160	800
	H 35 C mode		320	640	1,280	2,560	80	976
	PA 15*		80	320	80	320	20	164
			Serum no.	265/55	266/55	267/55	268/55	269/55
C	H 35 X mode		80	80	1,280	20	10	294
	H 35 I mode		20	160	2,560	320	320	676
	H 35 C mode		320	640	2,560	1,280	320	1,024
	PA 15*		< 10	< 10	10	< 10	< 10	< 10

* *B. parapertussis* PA 15 grown EM NaCl 4.0, 35° C. (i.e. in X mode)

Antigenic structure of the three equilibrium modes

The antigenicity of the three modes has been compared by the intravenous inoculation of groups of five turkeys, each with formalinized suspensions. All three suspensions were prepared at the same time from growths on EMP at 35° C. (with suitable salt additions) derived from a C-mode inoculum grown from a single colony. Each turkey received doses of 1, 2, 4, 4 and 4 ml. of suspension (of opacity equal to Brown's tube no. 9) at intervals of a week. The results (Table 10) agree with the previous X- and C-mode comparison in rabbits (Table 6) in showing both a highest mean titre for a given mode in antisera to that mode and a fairly constant ratio (c. 20:1) of mean X-mode titre to mean *B. parapertussis* titre in each group

As would be expected, the I-mode sera had mean X- and C-mode titres intermediate between those of the X- and C-mode sera.

A priori, the findings in all comparisons (Tables 6 and 10) could be attributed either (i) to changes in position of constant amounts of antigens, or (ii) to changes in position accompanying, or resulting from, changes in amount. In the first case the environment would primarily determine which antigen, solely because of its position, would dominate the antigenicity. In the second case, the environment would primarily determine the rates of synthesis of the various antigens; the most rapidly synthesized would be present in greatest amount and for this reason would both dominate the antigenicity and monopolize the surface. The effect of submersion on antigenicity is almost unknown but even if the fifty- to seventy-fold

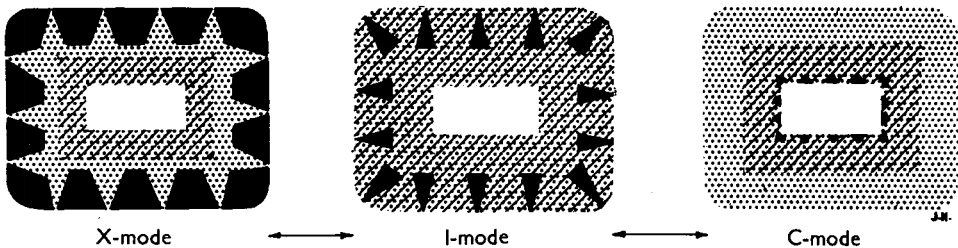

Fig. 6. Hypothetical antigenic constitutions of the three equilibrium modes of *B. pertussis* deduced from Tables 8–10. Major antigens are shown forming part of the surface, minor antigens touching the surface and minimal antigens submerged. ■, X antigen; ▨, I antigen, ▩, C antigen.

difference in X-mode titres induced by X and C modes were, according to hypothesis (i), attributed solely to change in position, there would still remain the difficulty of explaining how temperature, or ionic balance, could determine which antigen grew at the surface. In contrast, the influence of the physico-chemical environment on synthesis of antigens in other organisms, and on enzyme activity, is well known; and on the whole the second explanation (ii) seems much the more probable. On the assumption, therefore, that the amounts of the antigens vary, hypothetical antigenic structures of the three equilibrium modes have been deduced from Tables 9 and 10 and are presented in Fig. 6.

Quantitative influence of salts

Although any of the three absorbed pertussis sera, represented in Figs. 4 and 5, could have served as a constant end-point indicator in measuring the relative influence of different salts, the unabsorbed parapertussis serum has been used, having the advantage over pertussis X–C serum of not agglutinating I mode to a titre greater than 20. Any environment leading to growth with a titre (with the parapertussis serum) equal to the geometric mean of the usable range (40 with this serum) has been taken as neutral. Growth at this point corresponds closely to the mid-point (inflexion) between X and I modes.

A group of results with sodium chloride and sodium sulphate is shown in Fig. 7. From these, and similar results with other salts, the curves of Fig. 8 have been

drawn. Up to a final concentration of 0.25 N the neutral mixtures appear to be on a straight line. Each pair of salts thus has a constant ratio for neutrality. No tests have been made above 0.25 N because the viable count falls off rapidly above 0.3 N especially when neither salt contains magnesium. Fig. 8 is a kind of modal diagram because any mixture of salts above the line will lead to X mode and any below to I or C modes. The intercepts on the abscissa reveal the slightly pro-X balance of the medium (EMP) without added salt. Although this residual balance varies somewhat with the batch of blood, it is usually equivalent at 24.8° C., as here, to about 0.25 m. of 0.72 N sodium sulphate or 0.1 ml. of 0.72 N magnesium sulphate.

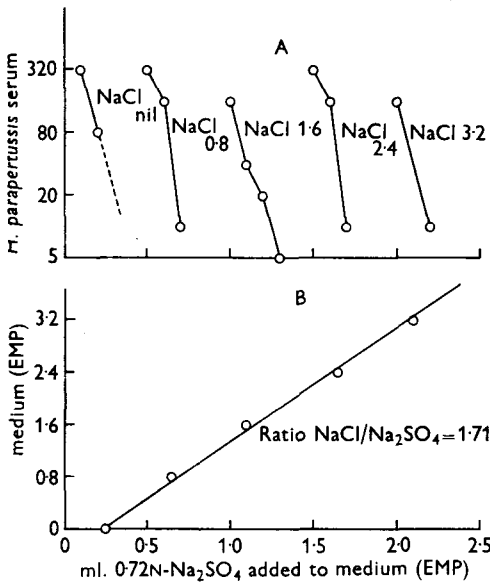

Fig. 7

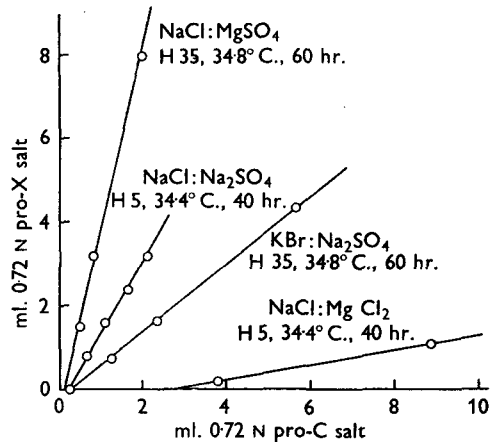

Fig. 8

Fig. 7. (A) Agglutinability of *B. pertussis* H5, grown at 35° C. for 40 hr., by *B. parapertussis* serum, as a function of the sodium chloride and sodium sulphate included in the medium (EMP). (B) Mixtures of sodium chloride and sodium sulphate in the medium (EMP) neutral for *B. pertussis* H5 when grown at 35° C. for 40 hr.

Fig. 8. Mixtures of salts in the medium (EMP) neutral for *B. pertussis*.

When the residual balance is known, the neutral ratio of a pair of salts can be determined from a titration at a single total concentration. Results of seven titrations are given in Table 11. The magnesium sulphate was increased in 0.05 ml. steps, the other pro-C salts in 0.1 ml. steps. With any of the pro-X salts the relative pro-C power (in terms of chemical equivalents) of magnesium sulphate appears to be about 2½ times that of sodium sulphate and 25 times that of magnesium chloride. This order corresponds to the order of their distances, in Fig. 1, from the neutral point and suggested that the pro-C power and distance (Fig. 1) might be simply related. After testing a number of ideas it was indeed found that, if 'effective' concentration (product of conductance ratio and equivalent concentration) was

Table 11. *Mixtures and ratios of 0.72 N salt solutions neutral for Bordetella pertussis H 35 grown on EMP for 60 hr. at 34.8° C.*

pro-C salt	pro-X salt				Volume in ml. (R) of 0.72 N pro-C salt solution needed to neutralize medium with no pro-X salt solution added (from the inter- cepts in Fig. 8)
	NaCl	KCl	NH ₄ Cl	KBr	
(i) Neutral mixtures					
Volume in ml. (V) of 0.72 N pro-C salt solution found to neutralize (4 - V) ml. 0.72 N pro-X salt solution (mean of three experiments)					
MgCl ₂	3.8	—	—	—	2.70
Na ₂ SO ₄	1.62	1.92	2.02	2.32	0.25
MgSO ₄	0.82	1.05	—	1.33	0.10
(ii) Neutral ratios: pro-X/pro-C = $\frac{4 - (V)}{(V) - (R)}$					
MgCl ₂	0.18	—	—	—	
Na ₂ SO ₄	1.74	1.23	1.12	0.80	
MgSO ₄	4.42	3.10	—	2.19	

used, the distance along the mid-line of Fig. 1 became proportional to the square root of the modulating power and that the ions could then be arranged in a way which would allow the influence of any mixture of the salts to be predicted with reasonable accuracy. The formula giving the best fit was as follows:

Quantitative influence of a salt in a given system is equal to the product of equivalent concentration, conductance ratio and square of the distance along the centre line of Fig. 1 from the point of balance.

Thus each salt could be considered as exerting a second-order moment analogous to a moment of inertia in which mass is represented by effective concentration and radius by distance. It follows that the qualitative influence of a mixture of salts is represented by the point on the centre line which is at its centre of inertia.

The derivation of the specific modulating power, and hence position on the centre line (mS), of twelve salts is shown in Table 12. From this a generalized nomogram (Fig. 9) has been constructed as follows: Let two parallel straight lines represent cations and anions and a third, midway between, salts, salt influence and type of growth. Let neutral conditions for *B. pertussis* H 35 at 34.8° C. be represented at N ≡ 7.0 on an arbitrary linear scale common to ions and salts. Put Na⁺ at 7.0 on the cation line and Cl⁻ at 5.0 on the anion line. NaCl is now represented at A at 6.0 on the salt line. AN = 1.0 and represents the square root of the specific pro-X power of sodium chloride (arbitrarily 1). From line 2 column (E) of Table 12 the length of the sodium sulphate balance arm is 1.46 when sodium chloride is 1.0 so that sodium sulphate is represented at B, at 8.46, and hence sulphate at 9.92. From line 1 MgSO₄ is at 9.91 and hence Mg²⁺ is at 9.90. From

line 5 $MgCl_2$ is at 7.415 and hence Cl^- should be at 4.93. But Cl^- has already been placed at 5.0 and there is fair agreement. Five other tests of fit are possible from the results of Table 12. Thus:

- from line 3 acetate is at 6.82, from line 6 at *c.* 6.68,
- from line 4 formate is at 6.20, from line 7 at *c.* 6.14,
- from line 9 potassium is at 6.64, from line 13 at *c.* 6.64,
- from line 10 ammonium is at 6.52, from line 12 at *c.* 6.58,
- from line 11 KBr is at 5.54, from line 14 at *c.* 5.58.

The five ions concerned have been placed in Fig. 9 from the means of these estimates.

Table 12. Derivation of balance arm ratios of neutral mixtures of various salts from observed neutral ratios with *B. pertussis* H 35 growing for 60 hr. at 34.8° C.

o.	Salt mixtures		(A) Observed ratio of equivalents for neutrality, pro-X/pro-C	(B) Conductance ratios of salts		(D) Ratio of effective con- centrations for neutrality. pro-X/pro-C (A) × (C)/(B)	(E) Ratio of balance arms pro-C/pro-X √(D)		(F) pro-X/NaCl
	pro-C	pro-X		pro-C	pro-X		pro-C/pro-X	pro-X/NaCl	
1	MgSO ₄	NaCl	4.42*	0.437‡	0.845‡	8.55	2.92	—	
2	Na ₂ SO ₄	NaCl	1.74*	0.692§	0.844§	2.12	1.46	—	
3	Mg Ac.	NaCl	1.38†	0.64	0.86	1.85	1.36	—	
4	Mg form.	NaCl	0.87†	0.68	0.86	1.10	1.05	—	
5	MgCl ₂	NaCl	0.18*	0.750§	0.844§	0.20	0.41	—	
6	Na ₂ SO ₄	Na Ac.	<i>c.</i> 80†	0.71	0.69	<i>c.</i> 82.5	<i>c.</i> 9.07	<i>c.</i> 0.16	
7	Na ₂ SO ₄	Na form.	10†	0.71	0.82	11.5	3.39	0.43	
8	Na ₂ SO ₄	NaNO ₃	1.56†	0.699‡	0.827‡	1.88	1.37	1.06	
9	Na ₂ SO ₄	KCl	1.23*	0.692§	0.860§	1.53	1.24	1.18	
0	Na ₂ SO ₄	NH ₄ Cl	1.12*	0.692§	0.860§	1.39	1.18	1.24	
1	Na ₂ SO ₄	KBr	0.80*	0.692§	0.866§	1.00	1.00	1.46	
2	(NH ₄) ₂ SO ₄	NH ₄ Cl	0.87†	0.71	0.86	1.05	1.02	1.21	
3	MgSO ₄	KCl	3.10*	0.437‡	0.860‡	6.09	2.47	1.18	
4	MgSO ₄	KBr	2.19*	0.437‡	0.85¶	4.26	2.06	1.42	

* From Table 11.

† From the mean of three titrations at a total concentration of 0.08N only.

‡ At 0.1N and 18° C., from MacDougall (1952).

§ At 0.1N and 25° C., from MacInnes (1939).

|| At 0.09N and 18° C., determined in this laboratory.

¶ At 0.1N and 18° C., extrapolated from 25° C. value from the MacInnes (1939).

For lack of a pure salt, or a satisfactory conductance ratio, or titration, only approximate positions for lithium, calcium, fluoride, thiocyanate, propionate and butyrate are given in Fig. 9. But these positions are probably accurate enough to show that the metal ions and the halides are in order of hydrated radius (Hartley & Raikes, 1927) and that the sequence of ions differs from both the Hofmeister series: Li-K-Na-NH₄-Mg; SCN-I-NO₃-Br-Cl-SO₄ and the order (Eisenberg, 1918) of their generyal toxicit for bacteria: Na < K < NH₄ < Li < Mg; SO₄ < Cl < Br = NO₃ < acetate < citrate < formate < SCN < I < F.

Butyrate and glutarate have about the same pro-C-mode-power as sulphate but, in both the mono and dicarboxylic series, pro-C-mode-power rises steeply with

increase in chain length. Approximate *equivalent-modulating-powers* of the sodium salts of the straight chain mono series are as follows: butyrate (C_4) 2.6; caproate (C_6) 15; heptylate (C_7) 50; caprylate (C_8) 170; pelargonate (C_9) 300; caprate (C_{10}) 240. Sodium pelargonate is thus some seventy times more powerful (equivalent for equivalent) than magnesium sulphate and is the most actively pro-C substance so far discovered.

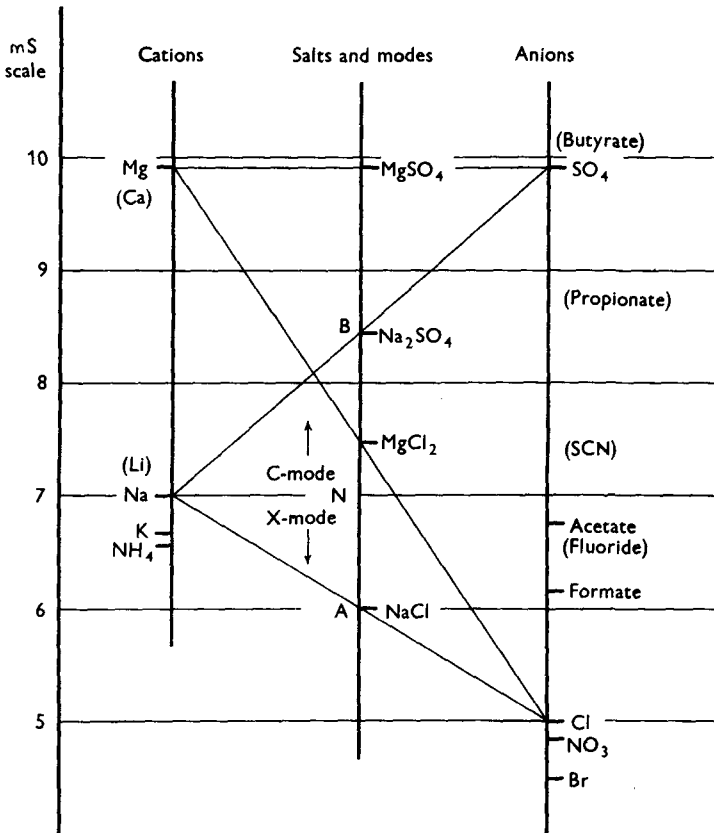

Fig. 9. Diagram relating ions and mode of *B. pertussis* H35 when grown on EMP at 34.8° C. for 60 hr. (Positions of ions in parentheses are approximate.) The mid-point on the line joining two oppositely charged ions represents a salt. The position of this point on the central line gives the modulating influence (mS) of the salt. Mixtures of two salts have an effective mS at their 'centre of inertia', i.e. point where their second moments balance. (Second moment = product of equivalent concentration, conductance ratio and square of distance in mS units.)

The combined influence of temperature and salts

The viable count of freshly isolated strains of *B. pertussis*, on either Bordet-Gengou or EM NaCl 4.0, after 12 days at 25° C. is usually between 10^{-5} and 10^{-7} of that on the same medium at 35° C. With none of some forty strains has it been more than 10^{-4} . Subcultures of colonies which grow at 25° C. yield full viable counts at both temperatures and are clearly selected mutants. Besides their ability to grow at 25° C., these have been found to differ from the wild

type in only one respect: a reduced tolerance of less blood in EM. They are referred to here as '25° C. mutants'. At 25° C. these mutants grow in C mode no matter what salt is included in EM. At 35° C. they behave precisely like the wild-type: the whole population modulates according to the salt content, state of the blood, etc.

To test the influence of temperature on salt modulation, the neutral ratio of sodium chloride to sodium sulphate in EMP (for a 25° C. mutant of strain H 5) was determined at three different temperatures. The method differed from that used for Fig. 7 only in using three levels of total salt concentration, instead of five. Nine or ten plates, differing by 0.1 ml. amounts of the 0.72 N solutions, were used in each of the nine titrations. The results, plotted in Fig. 10, show that at each

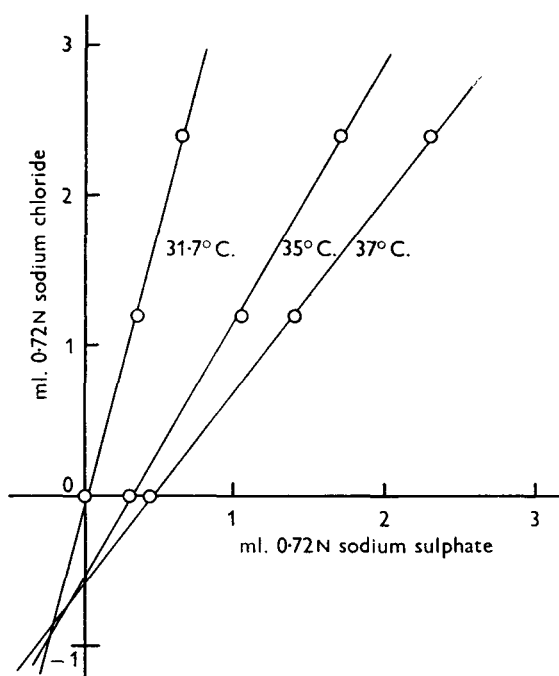

Fig. 10. Mixtures of sodium chloride and sodium sulphate in EMP neutral at three temperatures for 25° C. mutant of *B. pertussis* H 5.

temperature a certain ratio of salts is needed for neutrality and that the ratio, expressed as $\text{NaCl}/\text{Na}_2\text{SO}_4$, increased with fall in temperature. All three curves appear to have the same origin: at a point presumably representing an ideally saltless medium. It thus appears that, in this experiment, the medium (EMP) with no added salt had a basal salt content equivalent, in modulational influence, to a mixture of about 0.15 ml. 0.72 N sodium sulphate and 0.8 ml. 0.72 N sodium chloride.

With the four sera of Table 7, the influence of mixtures of magnesium sulphate and sodium chloride has been explored over a range of temperatures. The results are represented in Fig. 11. This closely resembles a phase diagram. It is of interest

in showing that, at any temperature above 27° C., the mode changes from X through I to C as the proportion of magnesium sulphate is increased. Similarly, at any sodium chloride:magnesium sulphate ratio greater than 2:1 a similar change of mode occurs as the temperature is lowered. Curve *AB* represents the inflexion conditions between X and I modes and *CD* those between I and C modes. No evidence has been found that growths from conditions represented by positions *C* and *D* differ in any way and it seems reasonable to regard *AB* and *CD* as lines of identical antigenic structure or, simply, iso-antigenic lines. In contrast, although growths from conditions represented within the zone *AEB* are always in X mode (i.e. their surface is demonstrably X) it is certain that their antigenic structures are not necessarily the same; for it is possible to remove the X antigen by solution in formamide-urea mixtures (details of which it is hoped to publish shortly) and the cells remaining from growth at, for example, conditions *E*, are then clearly distinguishable from those at *F*. There are thus indications that the diagram should be visualized as being covered by iso-antigenic lines running roughly parallel with *AB* and hence that *intra*-modal differences should be sought by comparison of growths from widely separated conditions along a line, such as *EH*, at right angles to *AB* and *CD*.

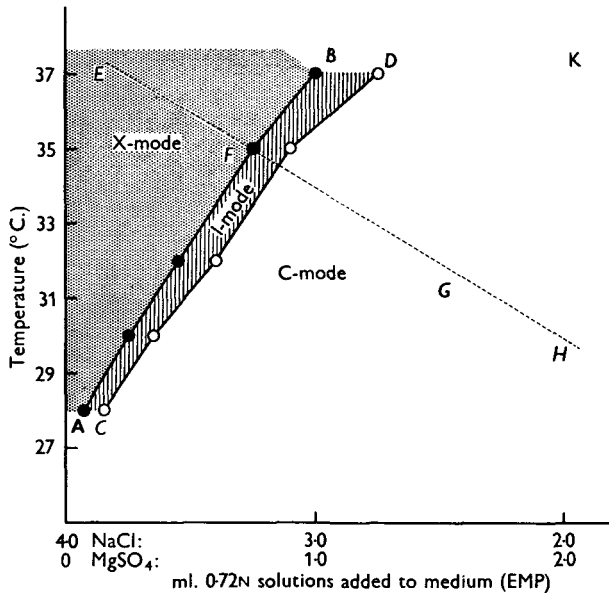

Fig. 11. Antigenic mode of 25° C. mutant of *B. pertussis* H 35 as a function of temperature of incubation and salts included in the medium (EMP).

To explore the relation of temperature and ions more fully, the modulating influence of mixtures of four ions: Na^+ , Mg^{2+} , SO_4^{2-} and Cl^- were examined at four temperatures in the usual way. Only the inflexion between X and I modes was titrated. The results (Table 13) were surprising in showing that the nomogram of salt influence had almost the same shape at each temperature and therefore that the influences of temperature and salt balance could be considered independent.

Table 13. Derivation and comparison of ion nomograms at four temperatures from observed neutral mixtures of three salt combinations with 25° C. mutant of *B. pertussis* H5 grown on EMP

(A) Salts pro-C, pro-X	(B) Temp. (°C)	(C) Observed neutral* 0.72N solutions (pro-C + pro-X) (ml.)	(D) Ratio of equivalents for neutrality† (pro-C:pro-X)	(E) Length of pro-C salt balance arm‡ (mS units)	(F) Position of pro-C salt (balance = 7.0) (mS scale)	(G) Position of ions and salts (mS scale)	(H) Position of neutral point on 34.8° C. scale§ (mS scale)
Na ₂ SO ₄ , NaCl	37	1.8 + 2.2	1.8:2.45	1.29	8.29	(i) SO ₄ ⁻	7.080
	34.8	1.5 + 2.5	1.5:2.7	1.48	8.48	9.58	7.000
	31.6	0.9 + 3.1	0.9:3.1	2.05	9.05	11.10	6.814
	28.3	0.2 + 3.8	0.2:2.8	4.14	11.14	15.28	6.483
MgSO ₄ , NaCl	37	0.9 + 3.1	0.9:3.35	2.68	9.68	(ii) Mg ²⁺	7.080
	34.8	0.75 + 3.25	0.75:3.45	2.98	9.98	9.78	7.000
	31.6	0.45 + 3.55	0.45:3.55	3.90	10.90	10.00	6.813
	28.3	0.1 + 3.9	0.1:2.9	7.49	14.49	13.70	6.469
MgCl ₂ , NaCl	37	4.0 + nil	—	—	—	(iii) MgCl ₂	7.100
	34.8	3.5 + 0.5	3.5:0.7	0.47	7.47	7.35	7.000
	31.6	2.3 + 1.7	2.3:1.7	0.91	7.91	7.49	6.793
	28.3	0.5 + 3.5	0.5:2.5	2.37	9.37	7.84	6.444

* Geometric mean titre (40) with *B. paraptussis* PA1 serum.

† From column (C) and volume of salt solution needed to bring medium to neutrality: 37° C.: +0.2 ml. 0.72N-Na₂SO₄/SO₄ ≡ -0.25 ml. 0.72N-NaCl; 34.8° C.: +0.1 ml. 0.72N-Na₂SO₄ ≡ -0.20 ml. 0.72N-NaCl; 31.6° C.: Nil; 28.3° C.: +1.00 ml. 0.72N-NaCl.

‡ Square root of product of column (D) in this table and appropriate ratio of conductance ratios from columns (B) and (C) of Table 12.

§ $6 + \frac{1 + (E) \text{ at temperature}}{1 + (E) \text{ at } 34.8^\circ \text{ C.}}$

|| From mean of observed (column (F)) and calculated values (column (G)).

It followed that a line representing temperature could be added to Fig. 9 to give the more generalized diagram shown in Fig. 12. In this the influence of temperature (t in °C.) is represented by a function (mT) such that:

$$mT = 6.7234 + \text{antilog}_{10} \left(\frac{27.03 - t}{13.92} \right),$$

and the combined influence $m(TS)$ of any temperature and salt balance, and hence also mode of growth, is represented at the intersection of an index line joining temperature (mT) and salt balance (mS) with the combined temperature-salt line (TS). Fig. 12 shows that any salt or salt mixture with mS greater than 7.2766 can be expected to have a pro-C influence at all temperatures, whereas the influence of salts with mS less than 7.2766 should vary with temperature. Sodium formate (mS about 6.58) certainly behaves as expected for it is pro-X and antagonistic to magnesium sulphate at 35° C., yet pro-C and synergic with magnesium sulphate at 28° C.

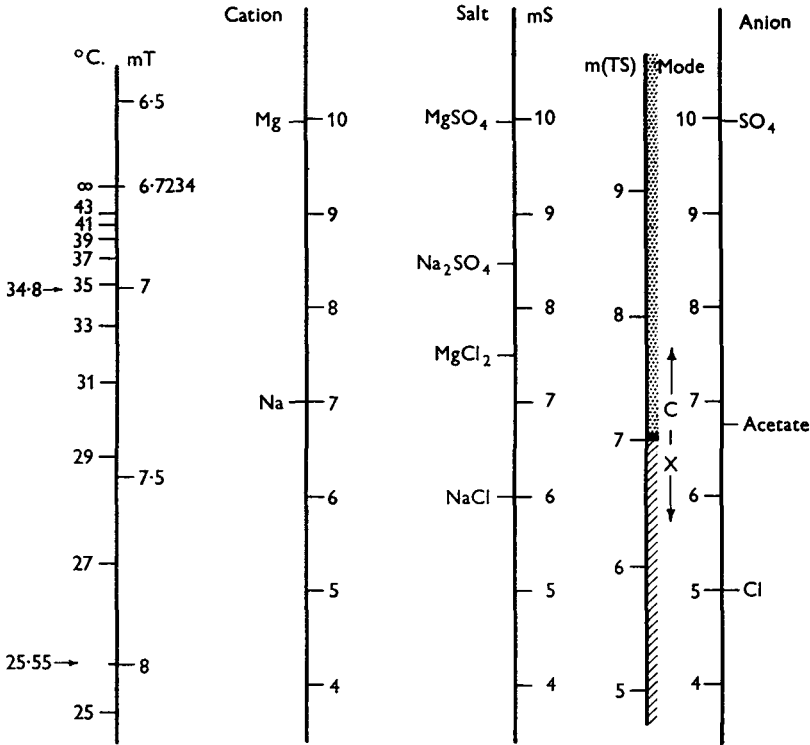

Fig. 12. Generalized nomogram relating antigenic mode of *B. pertussis* (25° C. mutant of H 35) to temperature of incubation and ionic composition of medium. The modulating influence of a salt or salt mixture (mS) is determined as in Fig. 9. The extension of a line from temperature through this mS gives the combined modulating influence of temperature and salts (m(TS)) and the mode of growth of *B. pertussis* H 35 (25° C. mutant) under these conditions.

The process of change from one mode to another

To examine the process of change from X to C mode, strain H 35 was subcultured twice on EMP NaCl 4.0 at 35° C., and a series of six tenfold-dilutions in digest broth, running from 10^{11} colony-producing units/ml., was made from the second culture when 60 hr. old. The whole surface of a separate plate of EMP MgSO₄ 4.0, previously warmed to 35° C., was then inoculated with 0.2 ml. from each dilution. Growth on the six plates at 35° C. was examined at intervals for haemagglutinating power and agglutinability by four sera: *B. pertussis* H 35 X - C, I - X and unabsorbed C-mode sera and *B. parapertussis* PA 1 BG 35° C. serum. The reverse change, from C to X, was followed in the same way. Change from X to I and the reverse was examined with growths from, or on, EMP NaCl 4.0 and EMP MgSO₄ 0.8, NaCl 3.2. Changes from the inflexion state between X and I modes (X, I growth) to C mode and the reverse was followed from, or on, EMP MgSO₄ 4.0 and EMP MgSO₄ 0.75, NaCl 3.25. From the results (Fig. 13) it can be seen that equilibrium was reached in all six changes between the 21st and 36th hour, i.e. after 7 to 12 subdivisions. This is precisely what would be expected on the assumption that (a) no loss of agglutinin occurs during modulation, and (b) the change from old

to new rate of synthesis occurs within an hour of transfer to the new environment. Consider the X antigen as an example. Let MX and MC be the amounts of X antigen in cells at equilibrium at 35° C. on EMP NaCl 4.0 and EMP MgSO₄ 4.0 (i.e. in X and C modes) respectively, and rX and rC be their rates of formation. Let M_n be the amount of X antigen in cells after n subdivisions.

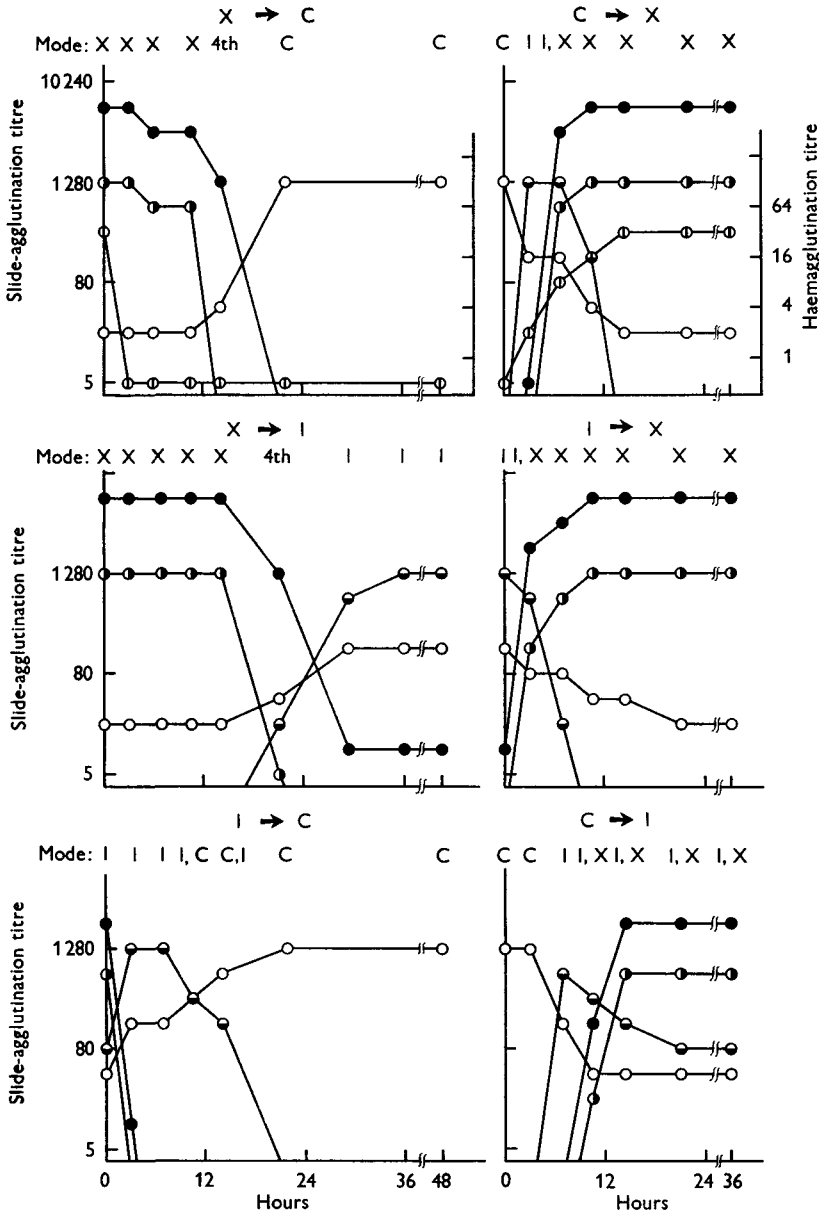

Fig. 13. Process of modulation of *B. pertussis* H 35 at 35° C. ●, X-C serum; ○, *B. parapertussis* PA1 BG serum; ●, I-X serum; ○, C-mode serum; φ, haemagglutination. All suspensions were tested with all four sera but titres less than 5 are not shown.

Clearly

$$MX/MC = rX/rC,$$

so that

$$M_n(X \rightarrow C) = \frac{rX + rC(2^n - 1)}{2^n}, \quad (1)$$

and

$$M_n(C \rightarrow X) = \frac{rC + rX(2^n - 1)}{2^n}. \quad (2)$$

Thus equilibrium would be closely approximated after seven subdivisions quite independently of the values of rC and rX .

In the change from X to C and X to I, the X antigen remained agglutinable for about 12 and 18 hr. respectively, whereas in the C to X and C to I changes it reappeared within 3–6 hr. These findings might also have been expected *a priori*. For from (1) and (2) it follows that

$$M_n(X \rightarrow C) \leq rX/2^n,$$

and

$$M_n(C \rightarrow X) \leq \frac{rX(2^n - 1)}{2^n}.$$

Hence in X to C modulation the X antigen would not be less than 6.125% of its X-mode amount at the 4th division and in C to X it would not be less than 75% of its X-mode amount at the 2nd division. The rate of formation of X antigen in I mode is almost certainly near the critical value for X antigen to appear on the surface; and all observed modulation of X antigen is predictable if the critical rate is assumed to be 5, and rX , rI and rC are assumed to be 100, 4 and 0.2 respectively.

C to X modulation clearly does not retrace the path of X to C change because (i) agglutinability to specific I mode serum (I–X serum) appeared transiently only during change from C to X, and (ii) in X to C, but not in C to X, a new type of agglutinability (4th mode) appeared transiently at about the time the X antigen disappeared. This 4th mode also appeared in the X to I change, but in no other. Antibodies to the 4th mode in X–C serum were found to be specifically removable with the mutant strain of *B. pertussis* H6 (see mutation and modulation p. 87) grown on EMP NaCl 4.0 at 35°C. It seems therefore that the 4th mode represents an X-mode cell without X antigen and direct evidence has been obtained that removal of X antigen by chemical means does leave a 4th mode-like surface.

Under pro-C-mode conditions the haemagglutinating power disappears long before the X antigen agglutinability is lost, just as it does when X-mode cells are suspended in physiological saline at 35°C. Its very rapid return under pro-X-mode conditions suggests that its presence, although obviously highly associated with X antigen, may not be entirely dependent on the presence of X antigen.

Modulation in perspective

It will be seen from Fig. 13 that at the seventeenth hour in the X to C change the growth was equally agglutinable by the C–X and C-mode sera. It might therefore be thought to be a 50:50 mixture of X- and C-mode cells. But each serum agglutinates the whole suspension, usually to less than its full titre, in fine granules and sometimes with prozone, whereas each serum agglutinates only

half the suspension of an artificial 50:50 mixture, to full titre, in coarse floccules and without prozone. Clearly, therefore, growths of this kind are homogeneous populations of cells of intermediate character. It follows that modulation in *B. pertussis* is not a saltative change but a process of continuous change leading at equilibrium to one of an infinite number of antigenic states.

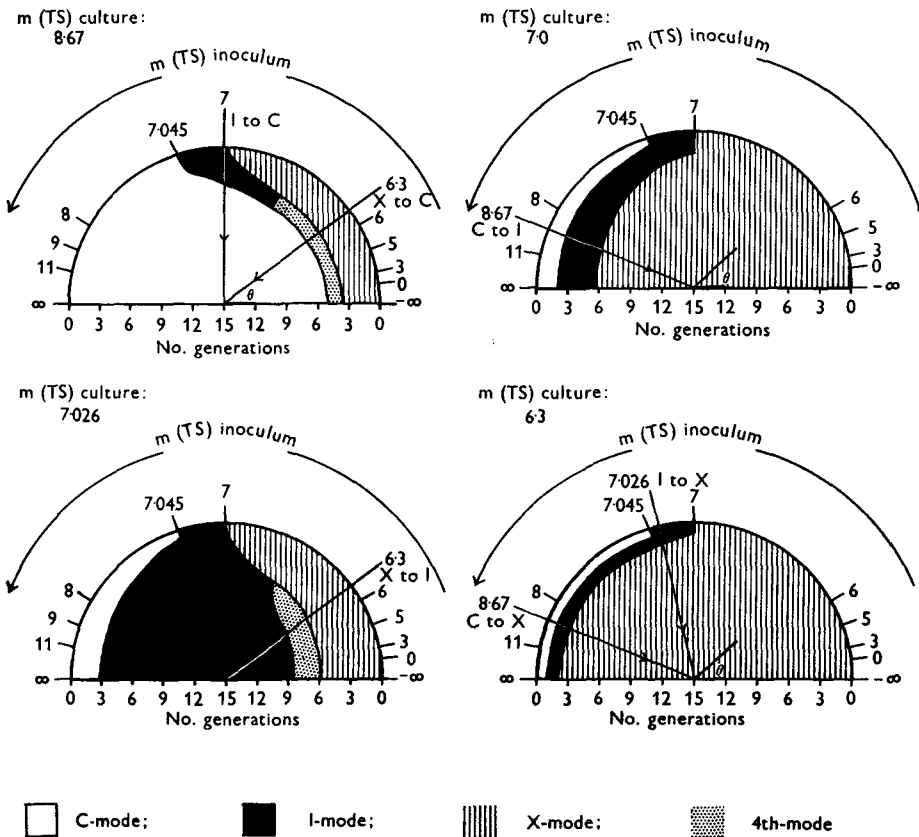

Fig. 14. Generalized views of antigenic modulation of *B. pertussis* H35 in four environments: largely derived from the results represented in Fig. 13. The equilibrium antigenic state of the inoculum is represented at the circumference on a scale such that cosec $\theta = 8 - m(\text{TS})$ or cosec $\theta = m(\text{TS}) - 6$. The six modulations of Fig. 13 are shown as centripetal radii.

Generalized views of modulation of *B. pertussis* H35, constructed largely from the results given in Fig. 13, are shown in Figs. 14 and 15. In these, temperature and salt balance of the inoculum ($m(\text{TS})$ inoculum) is represented horizontally on a circular scale such that cosec $\theta = 8 - m(\text{TS})$ or cosec $\theta = m(\text{TS}) - 6$ and number of generations is shown radially running towards the centre. In Fig. 14 the six modulations of Fig. 13 are represented by appropriate radii. Fig. 15 is a synthesis of Fig. 14 in which the $m(\text{TS})$ of the culture is represented vertically on a linear scale equivalent to the inoculum scale. The $m(\text{TS})$ units were transformed to

degrees in this way in order to include all theoretical values and magnify the transition between X and C modes.

Besides a three-dimensional diagram of this kind, some or all the following information would be needed to predict, even approximately, the antigenic structure of any particular growth:

- (a) Antigenic state of inoculum.
- (b) Number of viable organisms inoculated per unit area of medium.
- (c) Growth-promoting quality and thickness of medium.
- (d) Effective salt balance of medium.
- (e) Temperature of incubation.
- (f) Duration of culture.
- (g) Interval between removal from incubator and preparation of suspension.
- (h) Room temperature during (g).

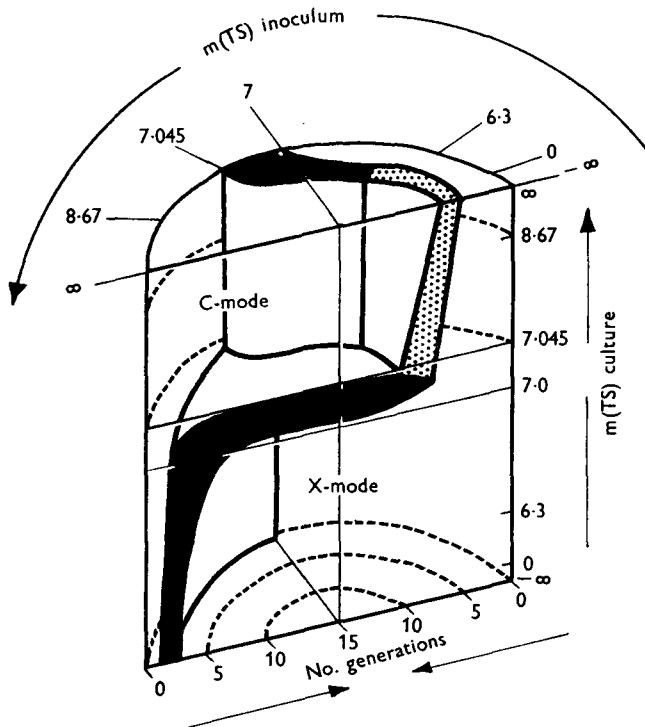

Fig. 15. A generalized three-dimensional perspective of salt- and temperature-induced antigenic modulation of *B. pertussis* H35: largely derived from Fig. 14. Every transient and equilibrium antigenic state and every modulation presumptively inducible by salts and temperature is represented within the hemi-cylinder.

In the absence of direct information about (a), all details (a) to (h) of the culture from which the inoculum was derived would be necessary, and conditions can easily be constructed in which information going back for several subcultures would be needed.

Serotype and modulation

The results of absorptions of X- $\frac{1}{2}$ and C-mode sera of two contrasting strains (the first four sera of Table 6) are shown in Table 14. From this it can be seen that

Table 14. Comparison of X- and C-mode sera of two contrasting serotypes of *Bordetella pertussis*: H5 and H15

Tested with	Slide-agglutination titres of									
	Serum: H5X no. 230/51*					Serum: H5C no. 217/51*				
	Nil	H5X	H15X	H5C	H15C	Nil	H5X	H15X	H5C	H15C
H5X	10,240	0	640	10,240	10,240	80	0	10	40	40
H15X	640	0	10	640	640	40	5	0	5	0
H5C	20	0	0	0	0	1,280	640	640	0	0
H15C	20	0	0	0	0	1,280	640	640	0	0
PA15BG	160	0	40	160	160	10	0	0	5	5

Tested with	Serum: H15X no. 229/51*					Serum: H15C no. 216/51*				
	Nil	H5X	H15X	H5C	H15C	Nil	H5X	H15X	H5C	H15C
H5X	640	0	0	640	640	80	.	10	.	.
H15X	2,560	1,280	0	2,560	2,560	80	.	0	.	.
H5C	160	5	0	0	0	640	.	40	.	.
H15C	160	5	0	0	0	640	.	40	.	.
PA15BG	20	0	0	10	10	0	.	0	.	.

0: < 5.

X: growth on EM NaCl 4.0, 35° C., at 60 hr. (X mode).

C: growth on EM MgSO₄ 4.0, 35° C., at 60 hr. (C mode).

PA15BG: *B. parapertussis* strain PA15 grown BG, 35° C.

..: not tested.

*: see Table 6 for origin.

in X mode, the strains are readily distinguishable and that specific sera can be made by cross-absorption of their X-mode sera by X-mode growths. These results are exactly those to be expected from the reactions of the two strains with Andersen's sera (see Table 1) and serve as a small confirmation, with strains isolated in Westminster, of Andersen's (1953) original findings. In C mode, however, no differences were found: both strains had the same antigenicity, absorbing power and agglutinability. To see if these strains were exceptional, and also compare the I modes of different strains, twenty-five more strains, isolated at Westminster during 1953, were subcultured from their medium of isolation (Lacey, 1954) in parallel at 35° C. on three media: Bordet-Gengou (for X mode), EMP MgSO₄ 0.75, NaCl 3.25 (for I mode) and EMP MgSO₄ 4.0 (for C mode), and then examined for antigenic differences. From the results, summarized in Table 15, it is concluded that serotypic differences are demonstrable only in X mode.

Mutation and modulation

In Fig. 16, the reactions of three fairly stable mutant types to changes in the salt content of the medium are compared with those of a normal (wild) type. The least degraded mutant (H5M), though indistinguishable from the normal under

Table 15. Search for intramodal antigenic differences among twenty-five strains of *Bordetella pertussis* grown at 35° C. for 60 hr.

Mode (and medium)	Method of examination	Results
X (on BG)	Agglutination on slide by Andersen's 2, 3, and 4 sera	17 strains: 2, 3, 4 5 strains: 2, 4 2 strains: 3 1 strain: 2, 3
I (on EMP MgSO ₄ 0.75, NaCl 3.25)	Agglutination on slide by specific I-mode sera (I-X) of strains H 5 and H 15	All agglutinated by both sera to titres from 40 to 320
C (on EMP MgSO ₄ 4.0)	(i) Agglutination on slide by a C-mode serum of each of the four serotypes recognizable in X mode (ii) Absorption of C-mode antibodies from two C-mode sera	All strains indistinguishable All strains indistinguishable

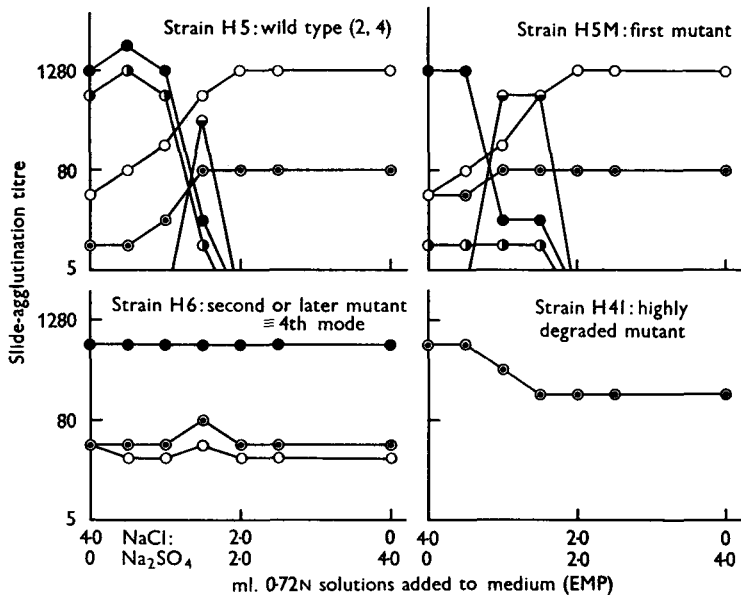

Fig. 16. Comparison of the effects of graded salt mixtures in the medium on the agglutinability by five sera of one wild and three mutant strains of *B. pertussis* when grown at 34.8° C. for 40 hr. ●, X-C serum; ○, *B. parapertussis* PA I BG 35° C. serum; ○, C-mode serum; ⊙, I-X serum; ⊚, strain H41 EMP NaCl 4.0, 35° C. serum. All suspensions were tested with all five sera but titres less than 5 are not shown.

pro-C conditions, was obviously different under pro-X conditions, appearing to have lost the ability of forming most, if not all, the X antigen. Strain H6 showed no modulation at all. Its antigenic state on all media was almost indistinguishable from that of H5M on EM NaCl 4.0. Thus H6 behaved as though it were a mutant of H5M which had lost the ability of forming both I and C antigens. Finally, strain H41 was not agglutinated on the slide by any of the four sera prepared

from undegraded strains and only its history and antigenicity serve to identify it as a highly degraded mutant of *B. pertussis*.

Only cells with X antigen in a serologically agglutinable form are fully sensitive to mercuric or gold chlorides (see Table 2). Insensitivity to heavy metals may therefore reflect either mutation, as Shimojo & Ishii (1954) independently discovered, or modulation.

Relation of modes to convalescent pertussis antibodies

The sera of fifty persons convalescent from whooping cough have been tested on the slide for agglutinins with suspensions of all three modes. Forty-two showed a titre of 4 or more with an X-mode suspension of H31 (a 2, 3, 4 strain), three a titre of 4 or more against a C-mode suspension, six a titre of < 2 against all modes and all a titre of < 2 against the I-mode suspension. Only two of the forty-two sera with X-mode antibodies were from adults, though all three sera with C-mode antibodies were from persons over 19 years old who had had a mild cough and positive nasopharyngeal swabs for 2-5 months. There is thus a slight indication that C-mode antibodies may be associated with a carrier state in which the organism is growing in conditions not occurring in the acute infection. This recalls the association of the carrier state after typhoid fever with Vi antibodies in the serum and the fact that both C-mode antigens and the Vi antigen (Felix, Bhatnagar & Pitt, 1934; Jude & Nicolle, 1952) are better developed at 37° C. than at higher temperatures.

Modulation and whooping cough

In cultural diagnosis a serum containing antibodies to all three modes is essential if the medium used is not strongly pro-X. Even with Bordet-Gengou, a polymodal serum is an insurance against both the accidental inclusion of highly potent pro-C substances, and the modulating effect of some contaminant colonies. Conversely, suspensions of different modes may be of value in antibody estimations. C-mode antibodies occur rarely in convalescence, and it is not surprising that Cashman (1955) found them in only one of seventy-six cord bloods and in none of seventy-eight maternal bloods. But their possible association with the carrier state already mentioned probably justifies further study.

In vaccine production the potential importance of modulation is obvious. At present there is no way either of making or testing a pertussis vaccine which will closely predict its value as an immunizing agent for children. The organism has to be grown according to an empirical rule with the fore-knowledge that each batch must be presumed different and of only doubtful value until proven effective in field trial with children, or presumed useful from the results of mouse protection tests (Pittman, 1952), ability to induce agglutinins (anti-X-mode) in the mouse (Evans & Perkins, 1953, 1954), or perhaps histamine-sensitizing power in the mouse (Pittman, 1951; Maitland, Kohn & Macdonald, 1955). There would therefore seem to be an immediate need to correlate antigenic state of growth with immunizing value in children. With mice, the scanty evidence so far available suggests that EMP MgSO₄ 4·0, 35° C., growth (i.e. m(TS) 9·67 growth) is of slight or negligible protectivity compared with EMP NaCl 4·0, 35° C., growth (i.e. m(TS)

6.3 growth). But between these extremes there are the I mode, the type of growth usually produced by Eldering & Kendrick's (1936) method (see also World Health Organisation, 1953) and an infinitude of other antigenic states. It would clearly be of interest to know which of these is the optimum, or if a mixture of modes is better than any one alone, or if an extracted antigen, of the kind described by Pillemer, Blum & Lepow (1954), is best of all. But a similar question in plague is still unanswered over half a century after Shibayama (1905) first reported the influence of temperature on the growth of *Pasturella pestis*.

SUMMARY

The antigenic structure of *Bordetella pertussis* varies continuously with environmental conditions of growth and, under suitable conditions, any of three forms (or modes) with markedly different antigenic surfaces may be developed. High temperatures and certain ions, such as sodium, potassium, halides, formate and nitrate, favour growth like that on Bordet and Gengou's medium at 35° C. Low temperatures and other ions, such as magnesium, sulphate and mono- and dicarboxylic acids with more than two carbon atoms, favour growth with a markedly different antigenic structure and character. These two extreme forms have been called X mode and C mode respectively. A third mode (called I mode) is induced within a narrow range of intermediate temperatures and ion ratios. Bacterial cells in C mode, unlike those in X mode, do not agglutinate red-blood cells, are not haemolytic or agglutinable by heavy metal salts, have no surface antigen related to *Bordetella parapertussis* or *B. bronchiseptica* and are serotypically homogeneous.

The influence of ions is a function of their species and ratios and not of their absolute concentrations or total ionic strength. A number of ions has been arranged in a pattern. In this the influence of any salt is represented at the centre of a line joining its component ions, and a measure of the influence of any salt mixture is given by the position of its imaginary centre of inertia. (For calculating this, mass is represented by the product of salt concentration and conductance ratio and radius of gyration by distance.) The influences of ions and temperature appear not to interact since their combined influence is proportional to the sum of their separate influences.

The change from one mode to another (modulation) occurs without mutation or selection, is complete within 7–15 cell divisions and appears to stem from altered rates of synthesis of at least three kinds of antigen molecule. During the process of modulation, antigens not detectable by agglutination in any of the three equilibrium modes (X, I and C) may appear transiently at the surface.

Mutants may or may not modulate. Modulatable mutants may be distinguishable from the wild type in only one mode. Almost all convalescent antibodies are directed against X mode, but C-mode antibodies have been found in several adults with persistent cough and infection.

I wish particularly to thank Dr E. K. Andersen for her generous gifts of sera, Drs P. L. Kendrick, H. Proom, A. F. B. Standfast and A. J. H. Tomlinson for gifts of cultures and Mr M. Breach for his invaluable help in the preparation of

media and sera. I am also indebted to the University of London Central Research Fund and the Governors of Westminster Hospital for grants towards the purchase of materials.

REFERENCES

- ANDERSEN, E. K. (1952). Some observations made during experiments on mice inoculated with *H. pertussis*. *Acta path. microbiol. scand.* **31**, 546.
- ANDERSEN, E. K. (1953). Serological studies on *H. pertussis*, *H. parapertussis* and *H. bronchi-septicus*. *Acta path. microbiol. scand.* **33**, 202.
- ARKWRIGHT, J. A. (1930). Variation. In *A System of Bacteriology in Relation to Medicine*, vol. 1, pp. 311-74. Medical Research Council. London: H.M. Stationery Office.
- ATWOOD, K. C., SCHNEIDER, L. K. & RYAN, F. J. (1951). Periodic selection in *Escherichia coli*. *Proc. nat. Acad. Sci., Wash.*, **37**, 146.
- BLOOM, W. (1937). Cellular differentiation and tissue culture. *Physiol. Rev.* **17**, 589.
- BORDET, J. (1912). Note complémentaire sur le microbe de la coqueluche et sa variabilité au point de vue sérodiagnostic et de la toxicité. *Zbl. Bakt. (I. Orig.)*, **66**, 276.
- BORDET, J. & SLEESWYK (1910). Sérodiagnostic et variabilité des microbes suivant le milieu de culture. *Ann. Inst. Pasteur*, **24**, 476.
- BRAUN, W., KRAFT, M., MEAD, D. D. & GOODLOW, R. J. (1952). The effect of penicillin on genetic changes and temporary modifications in populations of *Brucellae*. *J. Bact.* **64**, 41.
- BRIODY, B. A. (1948). Haemagglutination by influenza virus: III. The XO phase of influenza A virus. *J. infect. Dis.* **83**, 293.
- BRODIE, B. B. & HOGBEN, C. A. M. (1957). Some physico-chemical factors in drug action. *J. Pharm., Lond.*, **9**, 345.
- BURNET, F. M. (1953). Virus classification and nomenclature. *Ann. N.Y. Acad. Sci.* **56**, 383.
- CALABRESU, F., SPURRIER, W. & SCHWARTZ, S. O. (1956). Studies in Leukemia. V. Antigenic differences between leukemic and non leukemic red blood cells. *J. Lab. clin. Med.* **48**, 102.
- CASHMAN, A. J. (1955). Early immunization against whooping cough. *Brit. med. J.* **ii**, 589.
- COLE, L. J. & WRIGHT, W. H. (1916). Application of the pure-line concept to bacteria. *J. infect. Dis.* **19**, 209.
- CRUICKSHANK, J. C. & FREEMAN, G. G. (1937). Immunising fractions isolated from *Haemophilus pertussis*. *Lancet*, **ii**, 567.
- DOBELL, C. (1912). Some recent work on mutation in micro-organisms. II. Mutations in bacteria. *J. Genet.* **2**, 325.
- EISENBERG, P. (1912). Untersuchungen über die Variabilität der Bakterien. II. Über sogenannte Mutationsvorgänge bei Cholera-vibrionen. *Zbl. Bakt. (I. Orig.)*, **66**, 1.
- EISENBERG, P. (1918). Untersuchungen über spezifische Desinfektionsvorgänge. II. Mitteilung: Über die Wirkung von Salzen und Ionen auf Bakterien. *Zbl. Bakt. (I. Orig.)*, **82**, 69.
- ELDERING, G. & KENDRICK, P. L. (1936). Some practical considerations in *B. pertussis* vaccine preparation. *Amer. J. publ. Hlth*, **26**, 506.
- EVANS, D. G. & PERKINS, F. T. (1953). An agglutinin-production test in the study of pertussis vaccines. *J. Path. Bact.* **66**, 479.
- EVANS, D. G. & PERKINS, F. T. (1954). An improved method for testing the ability of pertussis vaccines to produce agglutinin. *J. Path. Bact.* **68**, 251.
- FELIX, A., BHATNAGAR, S. S. & PITT, R. M. (1934). Observations on the properties of the Vi antigen of *B. typhosus*. *Brit. J. exp. Path.* **15**, 346.
- FELL, H. B. (1954). The effect of environmental factors on the differentiation of the allantoic endoderm in organ culture. *J. Embryol. exp. Morph.* **2**, 348.
- FREUND, J. & BONANTO, M. V. (1944). The effect of paraffin oil, lanolin-like substances and killed tubercle bacilli on immunization with diphtheric toxoid and *Bact. typhosum*. *J. Immunol.* **48**, 325.
- GOLDSCHMIDT, R. (1938). *Physiological Genetics*. New York: McGraw Hill.
- HARTLEY, H. & RAIKES, H. R. (1927). The mobilities of the elementary ions in methyl alcohol. *Trans. Faraday Soc.* **23**, 393.
- HEKTOEN, L. (1918). The production of precipitins by the fowl. *J. infect. Dis.* **22**, 561.
- HILLEMANN, M. R. (1954). Antigenic variation of influenza viruses. *Annu. Rev. Microbiol.* **8**, 311.

- HILLEMANN, M. R. & GORDON, F. B. (1943). A protective antiserum against mouse pneumonitis virus. *Science*, **98**, 347.
- HINSHELWOOD, C. N. (1957). Ageing in Bacteria. In: *The Biology of Ageing* (eds. W. B. Yapp and G. H. Bourne), pp. 1-7. London: Institute of Biology.
- HUXLEY, J. S. (1955). Morphism and evolution. *Heredity*, **9**, 1.
- JONES, K. L. (1954). Variations in *Streptomyces*. *Ann. N.Y. Acad. Sci.* **60**, 124.
- JORDAN, E. O. (1915). Variation in bacteria. *Proc. nat. Acad. Sci., Wash.*, **1**, 160.
- JUDE, A. & NICOLLE, P. (1952). Persistence, à l'état potentiel, de la capacité d'élaborer l'antigène Vi chez le bacille typhique cultivé en série à basse température. *C.R. Acad. Sci., Paris*, **234**, 1718.
- KRUMWIEDE, C., MISHULOW, L. & OLDENBUSCH, C. (1923). The existence of more than one immunologic type of *B. pertussis*. *J. infect. Dis.* **32**, 22.
- LACEY, B. W. (1951). Antigenic modulation of *Haemophilus pertussis*. *J. gen. Microbiol.* **5**, xxi.
- LACEY, B. W. (1953a). Three dimensional patterns of antigenic modulation of *Haemophilus pertussis*, *H. paraptussis* and *H. bronchisepticus*. *J. gen. Microbiol.* **8**, iii.
- LACEY, B. W. (1953b). The influence of growth conditions on the antigenic structure of *Haemophilus pertussis*, *paraptussis* and *bronchisepticus*. *Atti del Congresso Internazionale di microbiologica*, **2**, sez. vi-vii, 331.
- LACEY, B. W. (1954). A new selective medium for *Haemophilus pertussis*, containing a diamidine, sodium fluoride and penicillin. *J. Hyg., Camb.*, **52**, 273.
- LANDAUER, W. (1948). Hereditary abnormalities and their chemically induced phenocopies. *Growth*, **12** (Suppl), p. 171.
- LE BOUVIER, G. L. (1955). The modification of poliovirus antigens by heat and ultraviolet light. *Lancet*, ii, 1013.
- LESLIE, P. H. & GARDNER, A. D. (1931). The phases of *Haemophilus pertussis*. *J. Hyg., Camb.*, **31**, 423.
- LURIA, S. E. & DELBRÜCK, M. (1943). Mutations of bacteria from virus sensitivity to virus resistance. *Genetics*, **28**, 491.
- MACDOUGALL, F. H. (1952). *Physical Chemistry*, 3rd ed. New York: Macmillan.
- MACINNES, D. A. (1939). *The Principles of Electrochemistry*. New York: Rheinhold Publishing Corporation.
- MAGILL, T. P. & SUGG, J. Y. (1948). The reversibility of the O-D type of influenza virus variation. *J. exp. Med.* **87**, 535.
- MAITLAND, H. B., KOHN, R. & MACDONALD, A. D. (1955). The histamine-sensitizing property of *Haemophilus pertussis*. *J. Hyg., Camb.*, **53**, 196.
- MELLON, R. R. & HAGAN, M. L. (1942). The polyphasic potencies of the bacterial cell; general biologic and chemotherapeutic significance. *J. Bact.* **44**, 1.
- MILES, A. A. (1939). The antigenic surface of smooth *Brucella abortus* and *melitensis*. *Brit. J. exp. Path.* **20**, 63.
- MILLER, J. J., JR. & SILVERBERG, R. J. (1939). The agglutinative reaction in relation to pertussis and to prophylactic vaccination against pertussis with description of a new technic. *J. Immunol.* **37**, 207.
- MONOD, J. (1947). The phenomenon of enzymatic adaptation and its bearing on problems of genetics and cellular differentiation. *Growth*, **11**, 223.
- MURRAY, J. (1944). Rh antenatal testing. A suggested nomenclature. *Lancet*, ii, 594.
- NETER, E., WESTPHAL, O., LÜDERITZ, O., GORZYNSKI, E. A. & EICHENBERGER, E. (1955). Studies of the enterobacterial lipopolysaccharides. Effects of heat and chemicals on erythrocyte-modifying, antigenic, toxic and pyrogenic properties. *J. Immunol.* **76**, 377.
- PHAIR, J. J., SMITH, D. G. & ROOT, C. M. (1943). Use of chicken serum in the species and type identification of *Neisseria*. *Proc. Soc. exp. Biol., N.Y.*, **52**, 72.
- PILLEMER, L., BLUM, L. & LEPOW, I. H. (1954). Protective antigen of *Haemophilus pertussis*. *Lancet*, i, 1257.
- PITTMAN, M. (1951). Comparison of the histamine-sensitizing property with the protective activity of pertussis vaccines for mice. *J. infect. Dis.* **89**, 300.
- PITTMAN, M. (1952). Influence of preservatives, of heat, and of irradiation on mouse protective activity and detoxification of pertussis vaccine. *J. Immunol.* **69**, 201.

- POVITZKY, O. R. & WORTH, E. (1916). Agglutination in pertussis. Its characteristics and its comparative value in clinical diagnosis, and in determination of genus and species. *Arch. int. Med.* **17**, 279.
- RAVIN, A. W. (1953). The nature of variations affecting bacterial adaptability. *Symp. Soc. gen. Microbiol.* **3**, 46.
- SCHMITT, F. O. (1956). Patterns of interaction of biological macromolecules in relation to cell function. *Proc. nat. Acad. Sci., Wash.*, **42**, 806.
- SCHÜTZE, H. (1932). Studies in *B. pestis* antigens. I. The antigens and immunity reactions of *B. pestis*. *Brit. J. exp. Path.* **13**, 284.
- SHEPHERD, C. J. (1957). The genome as a component of the ecosystem. *Symp. Soc. gen. Microbiol.* **7**, 1.
- SHIBAYAMA, G. (1905). Über die Agglutination des Pestbacillus. *Zbl. Bakt.* (I. Orig.), **38**, 482.
- SHIMOJO, H. & ISHII, T. (1954). Studies on the K antigen of *H. pertussis*. Its existence and a method of detection. *Jap. J. exp. Med.* **24**, 51.
- SLAVIN, D. (1950). Production of antisera in rabbits using calcium alginate as an antigen depot. *Nature, Lond.*, **165**, 115.
- SPIEGELMAN, S. & LANDMAN, O. E. (1954). Genetics of micro-organisms. *Annu. Rev. Microbiol.* **8**, 181.
- STAMP, LORD, (1947). The preservation of bacteria by drying. *J. gen. Microbiol.* **1**, 251.
- STANIER, R. Y. (1953). Adaptation, evolutionary and physiological: or Darwinism among the micro-organisms. *Symp. Soc. gen. Microbiol.* **3**, 1.
- TOENNIESSEN, E. (1915). Über Vererbung und Variabilität bei Bakterien. Ein Beitrag zur Entwicklungslehre. *Biol. Zbl.* **35**, 281.
- UNGAR, J. & MUGGLETON, P. W. (1949). The relationship of the aluminium phosphate precipitation of organisms of *Haemophilus pertussis* strains to their other biological properties. *J. gen. Microbiol.* **3**, 353.
- WADDINGTON, C. H. (1948). The genetic control of development. *Symp. Soc. exp. Biol.* **2**, 145.
- WADDINGTON, C. H. (1953). In discussion of: Observations on bacterial adaptation by S. C. R. Dean and C. Hinshelwood. *Symp. Soc. gen. Microbiol.* **3**, 21.
- WALLACE, J. H., DODD, M. C. & WRIGHT, C.-S. (1955). Antigenic studies of virus and trypsin-treated erythrocytes. *J. Immunol.* **74**, 89.
- WEINER, W., LEWIS, H. B. M., MOORES, P., SANGER, R. & RACE, R. R. (1957). A gene, y, modifying the blood group antigen A. *Vox sanguinis*, **2**, 25.
- WEISS, P. (1939). *Principles of Development*. New York: Henry Holt.
- WEISS, P. (1947). The problem of specificity in growth and development. *Yale J. Biol. Med.* **19**, 235.
- WEISS, P. (1949). Growth and differentiation on the cellular and molecular levels. *Exp. Cell Res.* (Suppl. 1), p. 475.
- WEISS, P. (1953). Some introductory remarks on the cellular basis of differentiation. *J. Embryol. exp. Morph.* **1**, 181.
- WESTERGAARD, M. (1957). Chemical mutagenesis in relation to the concept of the gene. *Experientia*, **13**, 224.
- WILSON, G. S. & MILES, A. A. (1955). *Topley and Wilson's Principles of Bacteriology and Immunity*, 4th ed. London: Edward Arnold.
- WINSLOW, C. E. A. & WALKER, L. T. (1909). A case of non-inheritance of fluctuating variations among bacteria. *J. infect. Dis.* **6**, 90.
- WOLFE, H. R. (1942). Precipitin-production in chickens. I. Interfacial titers as affected by quantity of antigen injected and aging of antisera. *J. Immunol.* **44**, 135.
- WORLD HEALTH ORGANISATION (1953). Diphtheria and pertussis vaccination. Report of a conference of heads of laboratories producing diphtheria and pertussis vaccines. *Wld Hlth Org. tech. Rep. Ser.* **61**.
- ZUCKERMAN, S. (1957). The human breeding season. *New Scientist*, no. 20, p. 12.