

# A Digitized Microphotometer and Some Applications\*

L. GRATTON, A. MARTINI, E. MARTINO,

G. NATALI and R. VIOTTI

Frascati, Laboratorio di Astrofisica Spaziale

## 1. INTRODUCTION; GENERAL PRINCIPLES

Despite the great progress which is being continuously made towards direct photoelectric recording, it is almost certain that for many years to come photographic plates will remain the most common means for detecting images of stars and stellar spectra, whether directly or through the intermediary of an image intensifier.

The photographic image of the spectrum of a star contains an enormous wealth of information whose utilization is one of the most important tasks of observational astrophysics. To achieve this task many difficult problems must be solved, the first being to express the information in a form which lends itself to further processing.

This is usually done by means of two different kinds of instruments.

A *measuring machine* permits to measure the wave-length of some spectral features to be later used for identification of spectral lines and qualitative chemical analysis and for the determination of the radial velocity of the star or of its external layers.

A *microphotometer* gives—after due processing—the flux of stellar light per unit wave-length. Thus an ordinary microphotometer tracing of the spectrum contains in analogue form information concerning both intensity and wave-length of spectral features; but usually the wave-length determination is not very accurate. Besides, the analogue form of recording the data requires very lengthy and tiring processing of the results.

The use of digitized machines is therefore by far to be preferred for their high speed and better accuracy; there can be little doubt that digitized instruments will replace in a short time the analogue ones, now that at least medium size computers are easily available to all astronomical institutions.

In developing the technique of digitized machines for the measurements of photographic images of stellar spectra, we followed at the Frascati Laboratory two different philosophies.

The first is to single out the information which one wants to extract from the plate for the investigation in hand through a suitable programme: e.g. wave-lengths and intensities (equivalent widths) of a limited number of lines. Since only useful information is recorded, the operation and successive processing are very fast; but the machine is rather complicated because the operative programme is read and performed by the machine itself. Also there is the need of some human intervention during the operation, which therefore is not fully automatic.

For this reason the machine constructed at Frascati on these principles was called MISA, an acronym from the Italian words “MIsuratore Semi-Automatico” (semiautomatic measuring machine). Although this machine is quite satisfactory in many respects we propose to change considerably its mechanical parts before putting it into routine operation.

In the following we give a fuller description of a machine built on the second principle, which is called MIDI, again an acronym from “MICrofotometro DIGitalizzato” (digitized microphotometer).

The MIDI philosophy is that of recording all the information contained in the plate whether useful or not; the selection is made in the process of reduction by the computer.

The operation, is then, slower than with the MISA, but can be rendered fully automatic, because the computer can be connected “on line” with the MIDI.

The MIDI is essentially a microphotometer of the classical type; the plate transmission recorded by a photomultiplier is read by a digitized voltmeter at regularly spaced points. It must therefore be clear that this is a completely classical instrument, the only difference from ordinary microphotometers being its digitization.

\* The description of the MIDI given by L. Gratton at Edinburgh has been here enlarged to give more constructional and operational details.

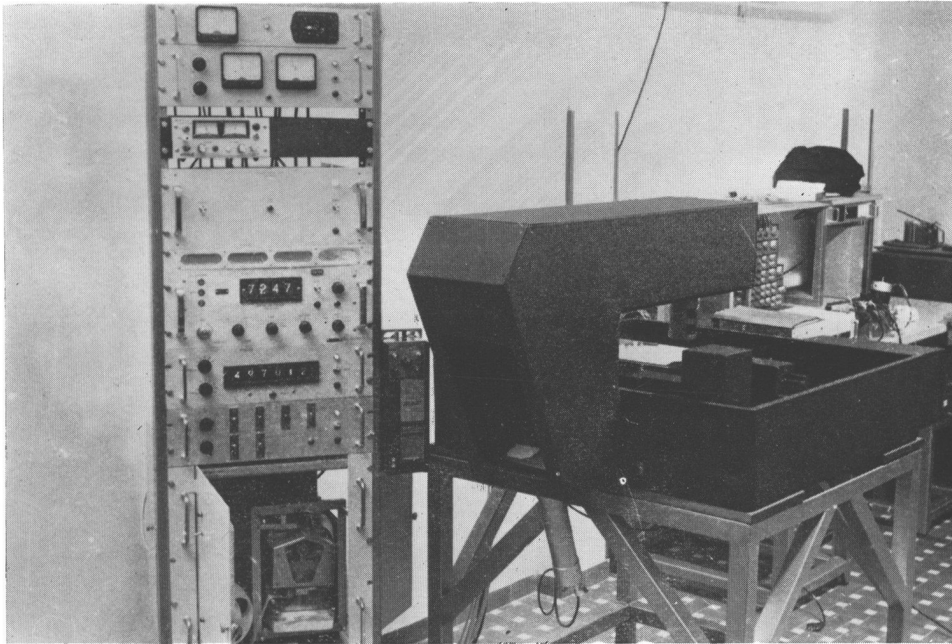

GRATTON *et al.* Fig. 1  
The 25 × 25 cm plate holder.

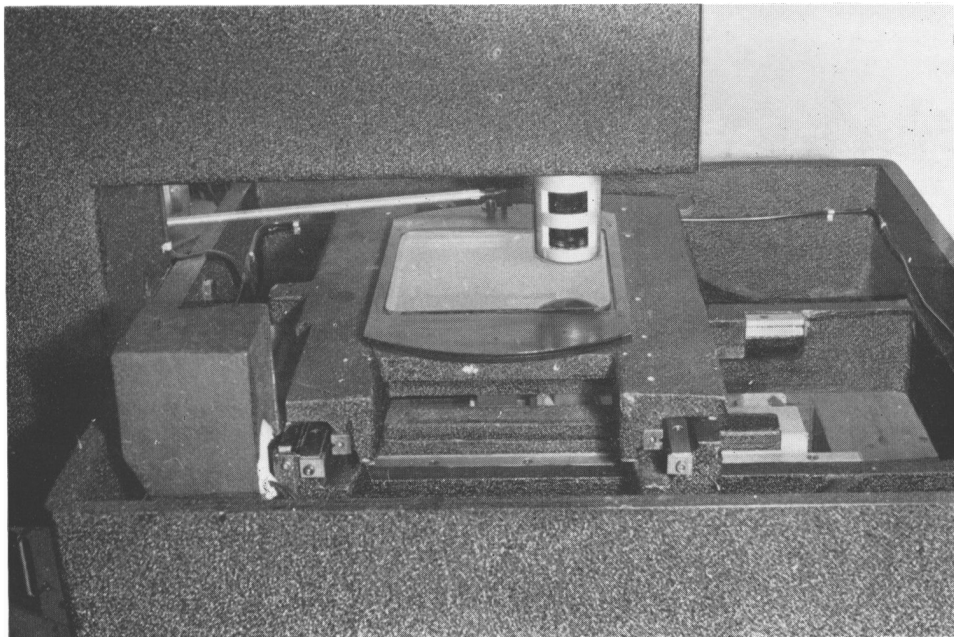

GRATTON *et al.* Fig. 2  
The digitized microphotometer (MIDI) and the electronic equipment.

The response is punched on tape or sent directly to the computer. An IBM 1130 system is used, but of course any kind of medium size computer can be employed.

A more complete description of the instrument is given in the following section; some applications are next shown together with a few tests of its performance.

Although we have not yet made a very extensive use of the instrument, the preliminary tests are exceedingly satisfactory.

The general design and principle of operation are due to L. Gratton; the mechanical parts have been constructed by an Italian firm (Società de Fisica Applicata); all the electronics have been designed

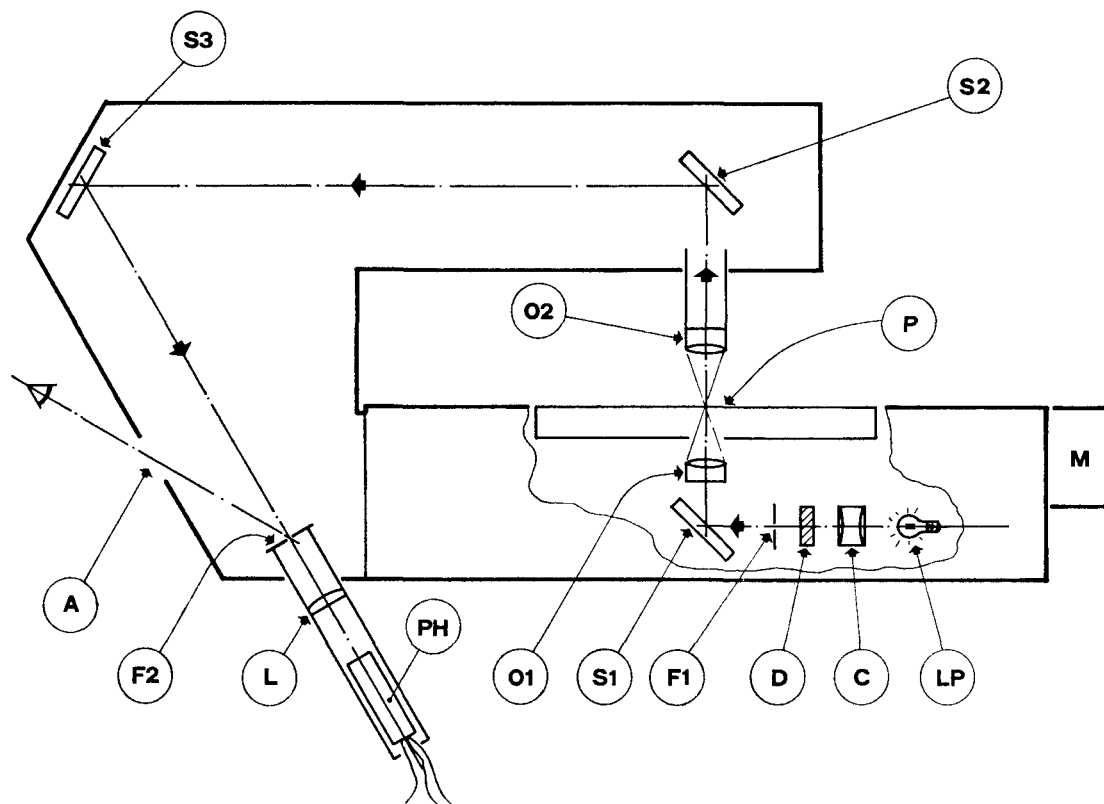

Fig. 3

The optical system of the microphotometer.

and constructed at the Frascati Laboratory by G. Natali; the programs which are described are due essentially to A. Martini, with the help of the chief computer E. Martino. The tests have been performed by R. Viotti.

Its low cost is not the smallest advantage of MIDI.

## II. DESCRIPTION OF THE INSTRUMENT

### (a) Mechanical and optical parts

Figure 3 shows schematically the optical and mechanical parts. The light from an 8V lamp LP goes through a heat filter D, a condenser C, and a mirror S1, and falls on the front lens of a high resolution objective O1. An adjustable slit in the plane F1 is focussed by the latter on the plate P to be scanned; the image of the slit on P is 1/3 its real size. The slit can be opened to show on the screen F2 a larger area of the plate, for setting purposes.

The objective O2 projects the plate onto the screen F2 and a second slit admits the light from the scanned area to the photomultiplier PH through a field lens L. An opening A in the chassis allows the operator to look at the screen.

The carriage admits plates up to  $25 \times 25$  cm and is moved in two coordinates by two screws actuated by d-c motors. The displacement in only one coordinate is measured by means of a device built by the German firm Heidenhain.

This device consists essentially of a glass plate 250 mm long fastened to the carriage, on which a series of lines is ruled on a chromium film (see Fig. 4a); each line is  $4 \mu\text{m}$  wide and 30 mm long and the spacing between the two lines is also  $4 \mu\text{m}$ .

A second plate fixed with the microphotometer frame and parallel to the first carries a pattern of lines, ruled also on chromium film, as shown in Figure 4b.

A beam of light goes through the two plates and falls on four photodiodes, each of them corresponding to one of the four zones of the fixed plate. When the carriage is in motion the signals from the

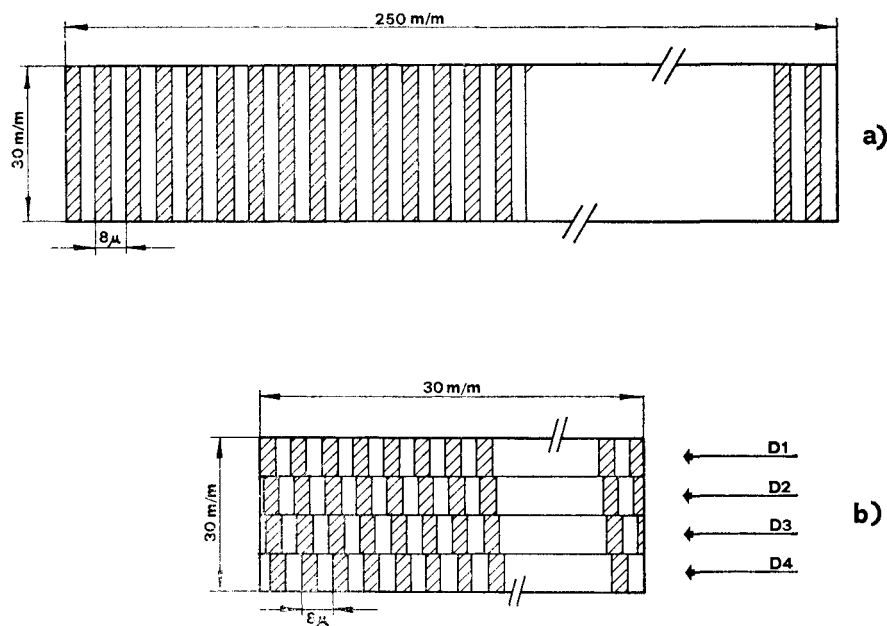

Fig. 4

The plate displacement measuring device: (a) carriage plate, (b) fixed plate.

photodiodes V1, V2, V3, V4, as shown in Figure 5, are sent to the electronics (MIDI-L2) where they are transformed in sequential pulses. The pulses are counted by a reversible counter and displayed as six-figure decimal numbers. The last figure corresponds to a  $1 \mu\text{m}$  displacement.

The plate displacement provides the abscissa on the plate corresponding to a certain feature; the corresponding photographic density is represented by the output of the photomultiplier PH, which is read in flight by a digitized voltmeter.

To avoid punching useless data the reading is made at equally spaced values of the displacement;

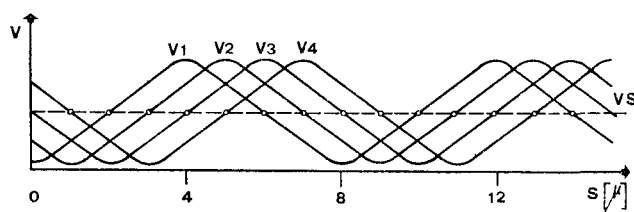

Fig. 5

The output voltage from the photodiodes.

the displacements are not recorded since they are represented by the serial number of the voltmeter readings which, alone, are punched on the recording tape.

It is therefore essential for a processing that the first reading starts at a known point of the spectrum. To this purpose at the beginning the plate is set with great care at the position of a known spectral line at the center of the interval to be measured; this fixes the zero. Then the length of the spectrum to be recorded is chosen and the carriage is moved in the negative direction somewhat more than half this length.

At the order "start" the carriage begins to move in the positive direction, but the actual recording starts only when it reaches the exact point where the interval to be measured begins.

Various spacings, corresponding to different displacement and also different lengths of the spectrum, can be chosen.

The speed of the carriage is determined by the spacings, since the voltmeter can read only a limited number of ordinates per unit.

The whole microphotometer is a very heavy and rigid cast-iron frame.

#### (b) *The electronics*

Figure 6 gives the general scheme of the electronics. MIDI-A2 and MIDI-A3 are respectively the power supplies for the lamp LP and the photomultiplier (Philips 150 AVP).

The MIDI-A2 power supply has been built at the Laboratory; it is able to supply a d-c current up to 10A with an output voltage between 6 and 10 V. The stabilization is of 0.014 per cent for a 10 per cent variation of the main voltage; the drift during continuous operation does not exceed 5 mV per 7.5 V.

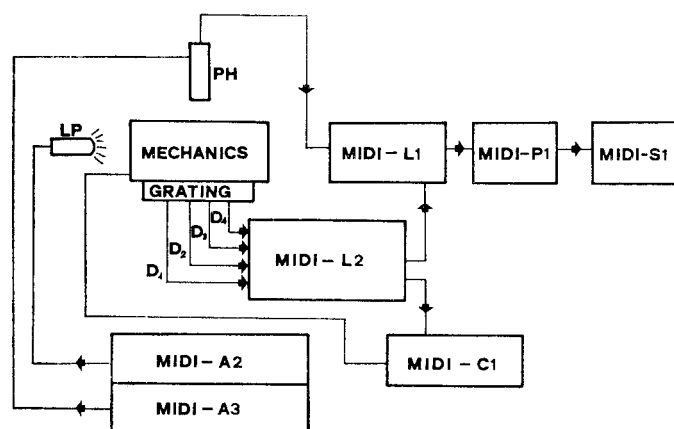

Fig 6

The functional scheme of the electronics of the MIDI.

The MIDI-A3 is a standard power supply (P27D of the ITALELECTRONIC) the output voltage ranging from 400 to 4000 V with currents up to 30 or 40 mA. Its stability is of 0.001 per cent for a 10 per cent variation of the mains voltage and 0.003 per cent for a change of 1°C of the room temperature.

MIDI-L2 receives the signals from the Heidenhain device, transforms them into pulses, counts the pulses, and orders the digitized voltmeter MIDI-L1 to read the output of the photomultiplier PH at the selected plate positions.

The voltmeter readings are encoded by the encoder MIDI-PI and punched by the fast printer MIDI-S1. The voltmeter is a DM 2005 of the firm "Digital Measurement"; it reads voltages from 0 to 2000 V in 5 scales with an accuracy of 0.014 per cent.

The microphotometer has been tested for distortion, reproducibility etc. and its performance found entirely satisfactory.

### III. DATA PROCESSING

Since the scientific programs of our Laboratory include the study of high and intermediate dispersion and objective-prism spectra, a number of data processing programs have been considered. The following is a short description of some of them, but it must be clear that this by no means exhausts the possibilities of MIDI and many more procedures can be considered. All our programs are suited for an IBM-1130 computer.

#### (a) *Reduction of plate noise*

The plate noise is due to graininess. The classical method consists in making the Fourier transform of the curve representing the microphotometer output and filtering out the high frequencies. A standard procedure has been developed and is shown in Figures 7 and 8. Figure 8 gives the frequency filter

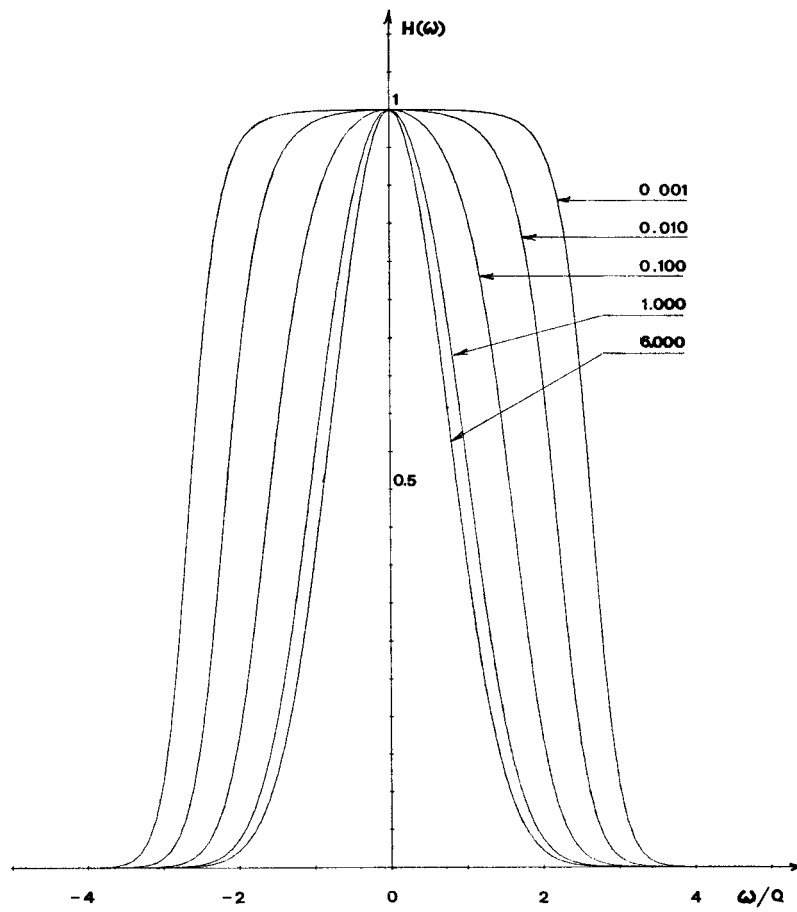

Fig 7

Reduction of the plate noise: frequency filter functions for different values of the parameter  $a$ .

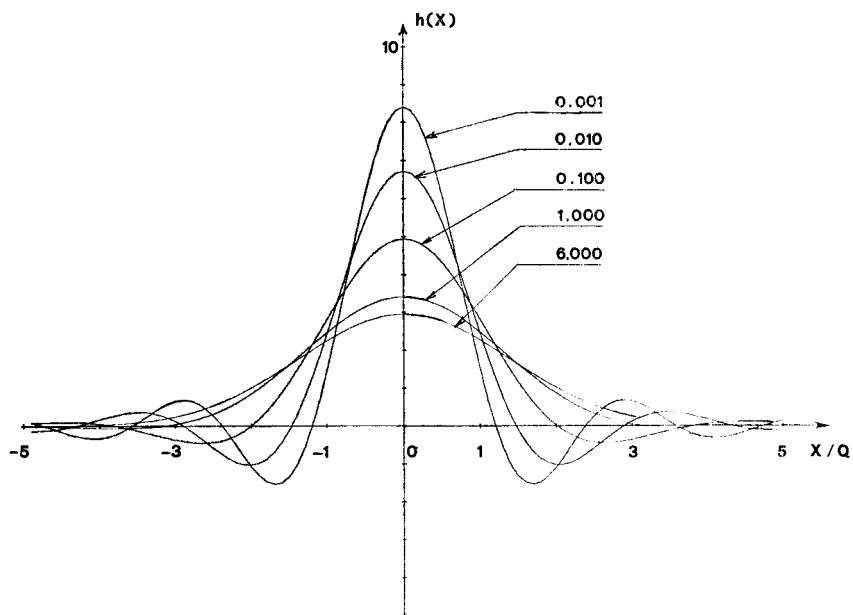

Fig 8

The filter functions corresponding to the frequency functions in Figure 7.

functions for different values of a parameter  $a$  which depends on the ratio of the size of the plate grain to the width  $Q$  of the spectrograph slit (or stellar image in the case of objective-prism spectra). Figure 8 is the corresponding filter function of the spectral curve. Figure 9 gives the result for a star; the faint tracing is the original microphotometer response, the heavy curve is the same after noise reduction.

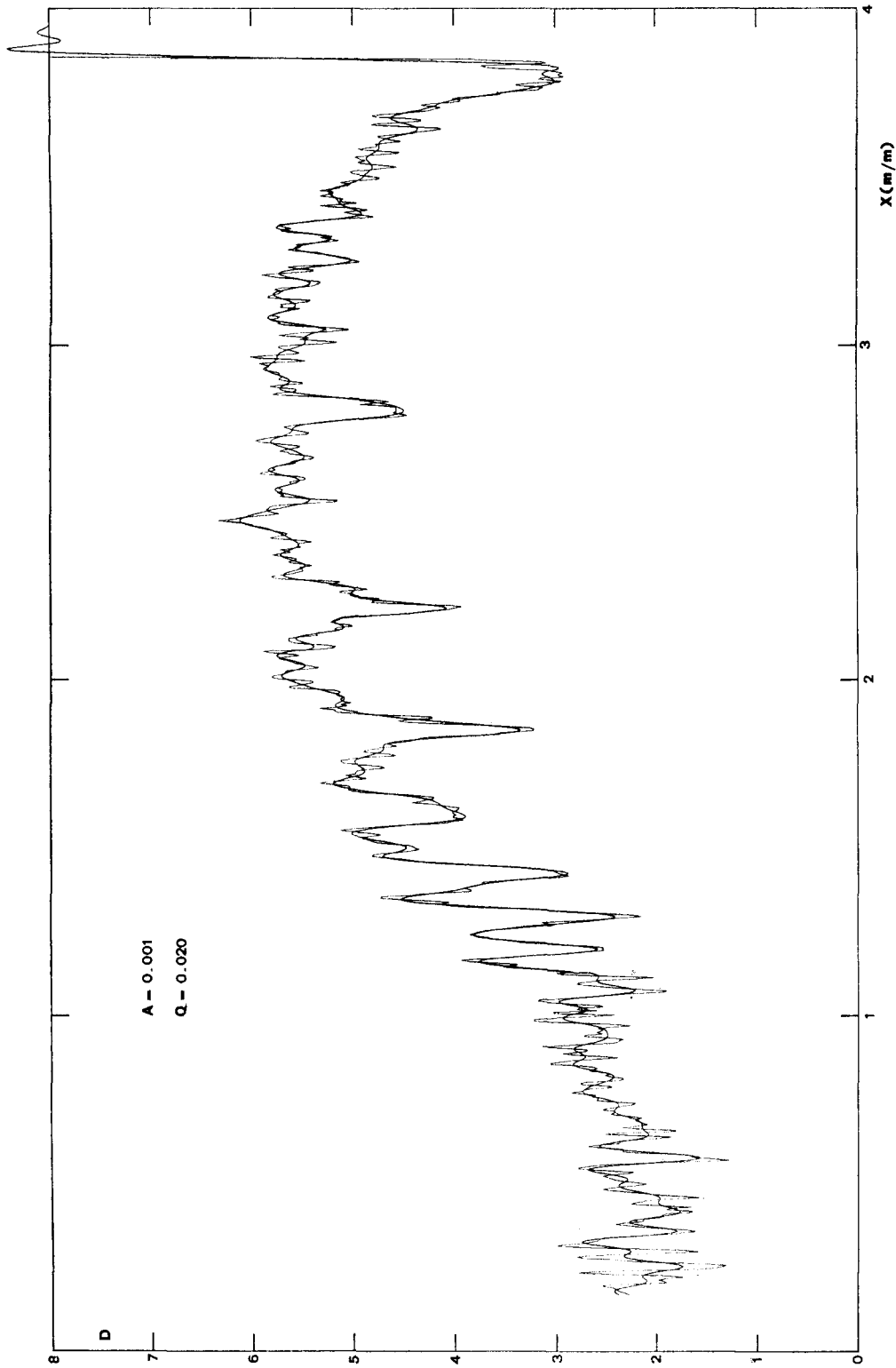

Fig. 9  
The result of the noise smoothing of an objective prism spectrum of BD +21° 560, obtained with the 60/40 cm Schmidt telescope of the Asiago Observatory. Faint curve: original microphotometer response. Heavy curve = the same after noise reduction.

The value of  $a$  is not very critical; it may be estimated from the tracings themselves. The star is BD + 21°560 in the Pleiades; the original dispersion was 450 Å/mm at H $\lambda$  (objective-prism spectra).

When several spectra of the same star are available, the MIDI affords a very convenient way to combine the result in a single curve; for this purpose the original response must be first reduced to intensities (or logarithms of intensities) by means of a calibration curve. Figures 10 and 11 show the result of combining two objective prism spectra of  $\alpha$  Lyr; for comparison we give in Figure 10 the two separate spectra and in Figure 11 the combined result.

(b) *Reduction to intensities*

Since the output of the MIDI is already in digitized form, the calibrations on the plate can be read

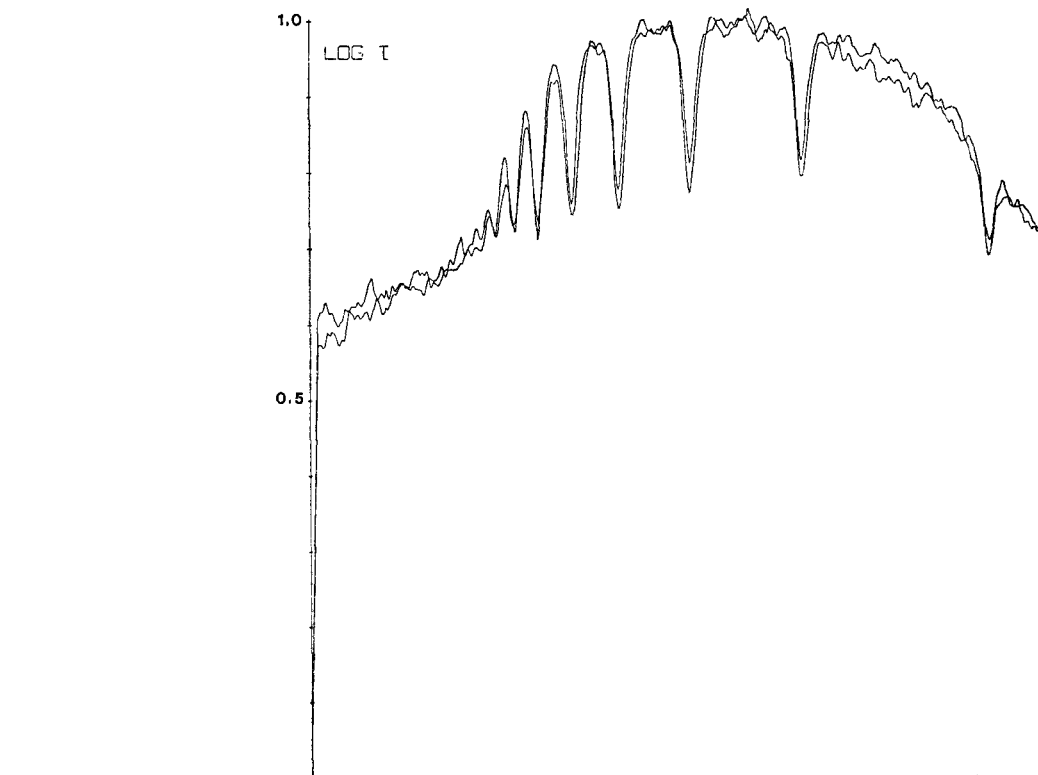

Fig. 10

Two objective-prism spectra of  $\alpha$  Lyrae obtained with the 90/60 cm Schmidt telescope of the Asiago Observatory. Ordinate is on magnitude scale, abscissa is displacement along spectrum.

and averaged and the corresponding characteristic curve interpolated at once. Figure 12 shows the result of combining 16 recordings of the calibration of IIAO plates and fitting with a 7th degree polynomial. Figure 13 shows a portion of the spectrum of a K star reduced to intensity ( $\phi^2$  Ori, region 5200–5300 Å). The continuum is computed with an iterative procedure. The recording of a 20 cm spectrum at steps spaced 10  $\mu$ m requires about one hour, and one hour further is required to reduce it to intensities and make the tracing with our plotter; when the on-line connection is realized the required time will be greatly reduced.

(c) *More elaborate programs*

More elaborate programs are available and cannot be described in detail\*; the block diagrams of Figures 14 to 17 are self-explanatory. Figures 14 and 15 show a program for the reduction of objective prism spectra.

Since the IBM 1130 computer has only 8K storage bits, it was necessary to divide the program into three sections: MM01, MM02, MM03. MM02 and MM03 are linked together.

MM01 can start when the storage on file of the density data has been completed and input data

\* A paper by A. Martini and E. Martino will be published in the near future giving more details.



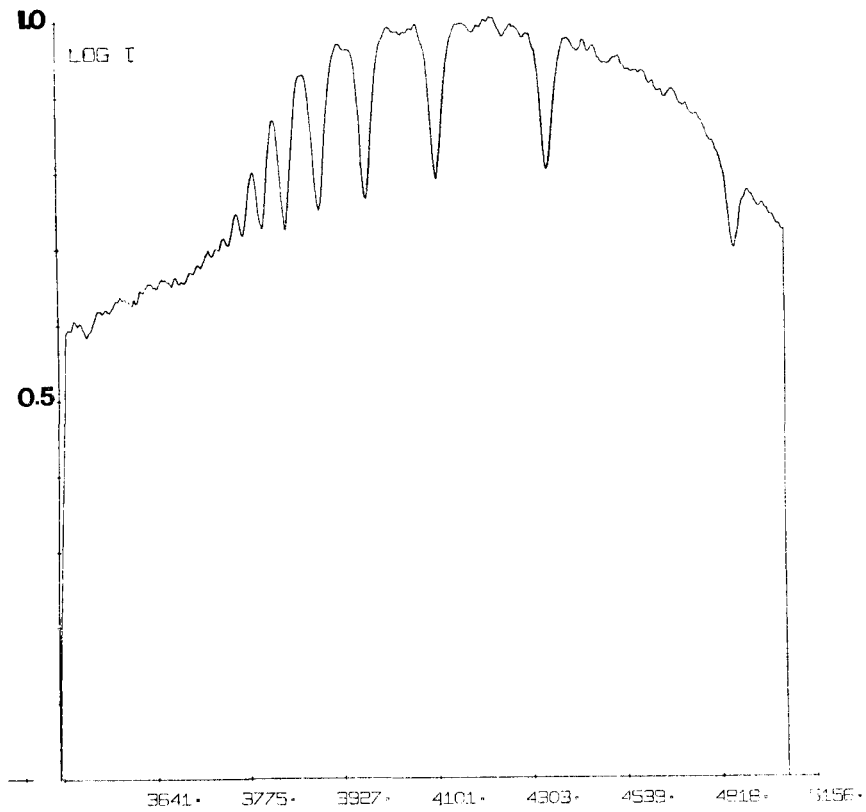

Fig. 11  
The result of combining the two spectra in Figure 10.

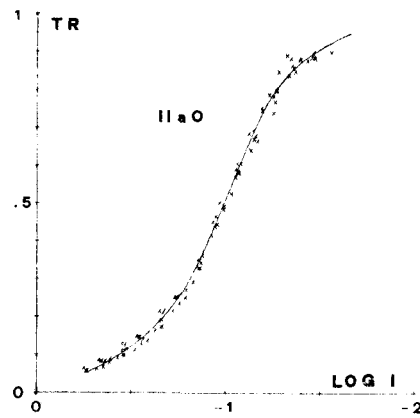
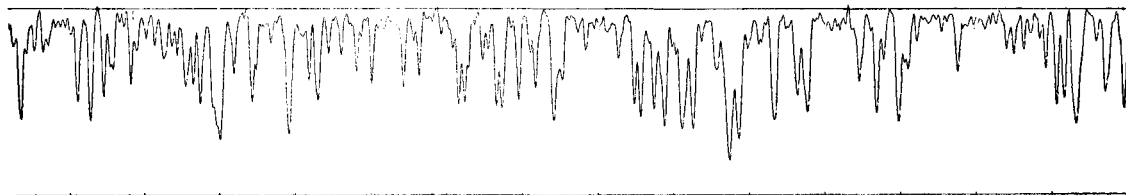

Fig. 12  
The mean characteristic curve for IIaO plates averaged from 16 recordings of the step-wedge calibration of the Dominion Astrophysical Observatory.



**SPECTRUM OF A K-TYPE STAR**

Fig. 13  
The intensity tracing and the computed continuum of a portion of a high dispersion spectrum of a K-type star ( $\phi^2$  Ori, 5200–5300Å) obtained at the D.A.O.

given. The input data consist of "instrumental data" and calibration curve. The instrumental data refer to the various parameters of the microphotometer fixed on scanning the spectrum and necessary to the computer to interpret the density data. They are: (a) the scanning pitch; (b) the starting position of the microphotometer, expressed in mm with an accuracy of  $\pm 1 \mu\text{m}$ ; (c) the wavelength of the line which has been centered on the above mentioned position; (d) the length of the scanned spectrum (which can be pre-fixed on the microphotometer); (e) the wavelength region at which corresponding mean ordinate the spectrum will be normalized; (f) the dispersion formula. The calibration curve is given in form of polynomial coefficients.

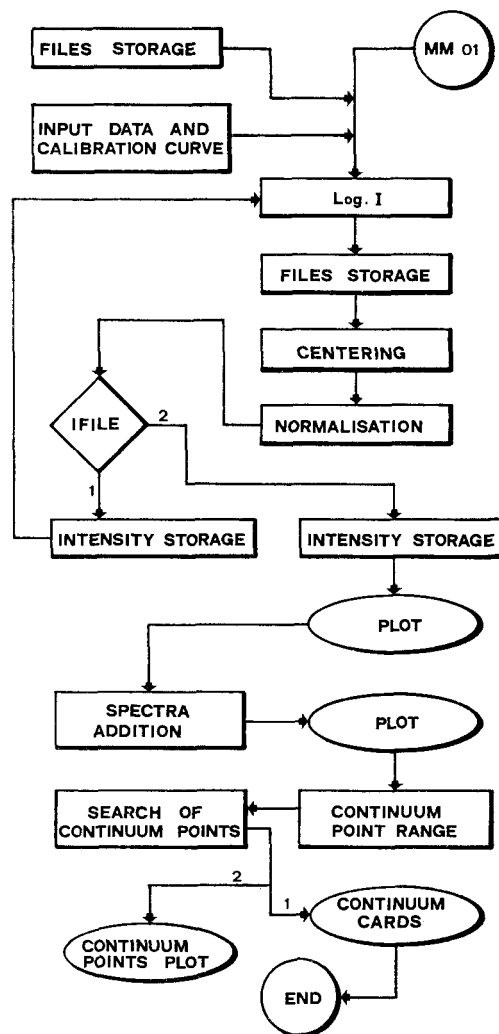

Fig. 14

Block diagram of the program for the reduction of objective-prism plates.

The main characteristic of MM01 is the possibility to treat together two or more spectra of the same star and, if desired, to combine them. For this operation, a centering of the X-scale (plate displacement) and a normalisation of the Y-scale (microphotometer output) are necessary. The centering is carried out by searching for the minimum of the "starting line" of the microphotometer.

The superimposition of five spectra ( $430 \text{ \AA}/\text{mm}$  at  $H\gamma$ ) of  $\alpha$  Lyr is shown in Figure 18. The plot of their mean is shown in Figure 19. It is significant and encouraging to note that by increasing the number of spectra the noise is eliminated and weak lines or blends identified with certainty (see also Figures 10 and 11).

After final plot, the continuum search process begins: the spectrum is divided into a pre-fixed number of wavelength regions and for each of them the highest ordinate is found. These "tops" are plotted upon the spectrum and punched on cards.

At this point the first stage of processing is concluded and a check on the plot can be made: if the spectrum is not overexposed and continuum points are satisfactory, the operator can give the continuum cards as input data for the second section of the program (MM02) which finds the continuum by fitting a Fourier curve through the given points.

The third section, MM03, finally carries out the equivalent width measurements, input data being clearly the wavelengths of the lines selected for measuring. The equivalent width is measured, for each

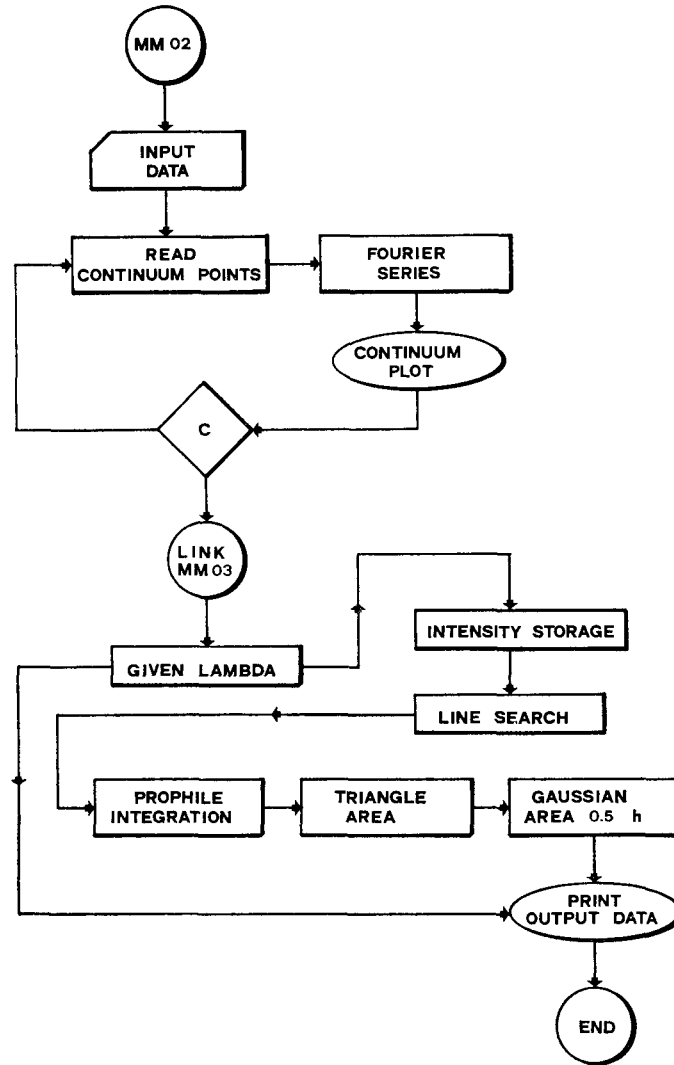

Fig. 15  
Continuation of Figure 14.

line, in a number of ways and printed as final output. Table 1 gives the intensity of the hydrogen lines as derived from the spectra in Figures 18 and 19.

TABLE 1  
EQUIVALENT WIDTHS IN  $\alpha$  LYR ( $\text{\AA}$ )

Line	Spectrum No.					Mean Spectrum
	1	2	3	4	5	
H $\beta$	8.15	8.84	7.95	8.80	8.12	8.17
H $\gamma$	9.36	10.20	9.96	9.60	10.68	10.00
H $\delta$	8.99	10.35	8.80	8.91	11.26	10.16
He	9.93	9.50	9.95	8.75	11.20	9.80
L						

Obviously, equivalent widths measured at such low dispersion cannot be very reliable, but the internal agreement, as can be seen from Table 1, is good, and they may be used, together with continuum points or gradients, as spectrophotometric criteria in statistical work.

Table 2 shows the time required by the various stages of the program. The total reduction time for a single objective-prism spectrum is about 10 minutes including the plot.

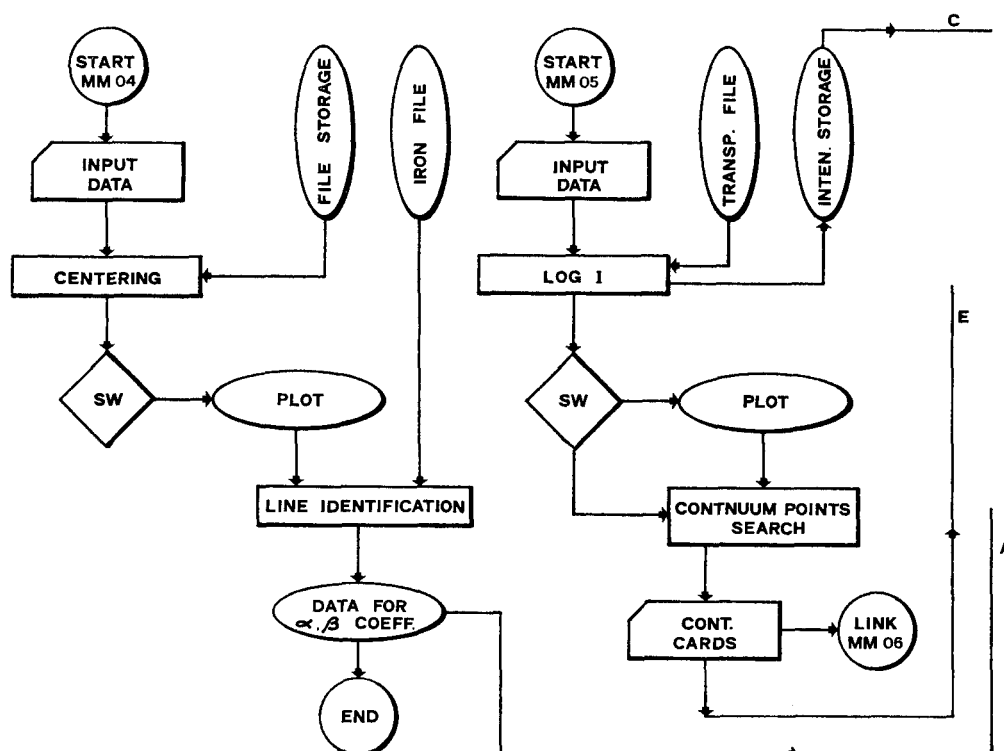

Fig. 16

Block diagram of the program for the reduction of slit spectra.

TABLE 2

Stages of Program	Time (in minutes)
MMO1 (including plot)	about 6
MMO2 (including plot)	about 2
MMO3	about 2

Figures 16 and 17 refer to a program for the reduction of slit spectra.

Due to the very high accuracy of the displacement of the carriage in the MIDI, it is possible to have accurate positions associated with the density measurements. If a line of the comparison spectrum is centered on the "starting position" of the microphotometer, it is possible to obtain the zero point of the X-scale. In this case, if radial velocity measurements are required or if the dispersion formula has a limited range of validity (such as in the case of spectra taken with a prism spectrograph) one can scan first the comparison spectrum by masking the portion of slit covering the stellar spectrum, then the stellar spectrum by masking the two portions of slit covering the two comparison spectra: in such a way two distinct sets of data are obtained, which are referred to the same abscissa. The first set (comparison spectrum) can be reduced for positions only, and given the exact dispersion formula at each wavelength.

Thus, the reduction program has been divided into two sections; the first (MM04) is assigned only to comparison spectra and may be skipped if only intensity measurements are required; the second (MM05 + MM06 + MM07) operates on stellar spectra.

MM04 can start when file storage of the density data of the comparison spectrum has been completed and input data given. The input data consists only of the "instrumental data" already described in the case of MM01. The first step is the centering (as in MM01). Then, by starting from the centering

line (all the wavelengths of the lines of the comparison spectrum are stored once for all) and using the approximate dispersion formula, the second line is found, centered and the residual (obs.-calc.)  $\Delta i$  is stored. The process continues until all the lines have been found. The values of  $\Delta i$  are best fitted against their positions and so the corrections for each position of the stellar spectrum (comparison and stellar spectrum have the same abscissa) are available.

MMO5 can start when file storage of the density of the stellar spectrum has been completed and input data given. The input data consist of "instrumental data", "stellar data" and calibration curve. Stellar data are: (a) right ascension and declination; (b) Universal Time (of observation) in days, months, years; (c) a rough radial velocity of the star.

The various steps of MMO5 proceed as in MMO1 and MMO2. MMO7 (as MMO3) carries out the radial velocity (reduced to the Sun) and equivalent width measurements, input data being the

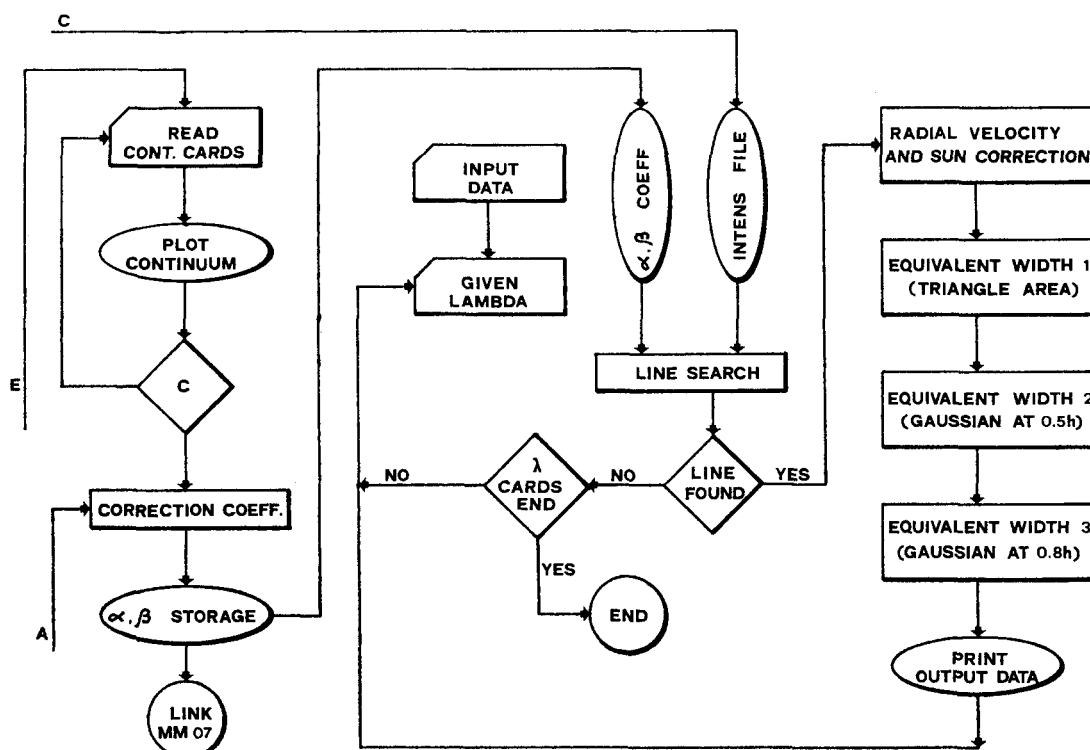

Fig. 17  
Continuation of Figure 16.

wavelength of the lines selected for measuring. The equivalent width is measured in three different ways: (a) triangle area; (b) gaussian area at 0.5h; (c) gaussian area at 0.8h.

At present only two stars ( $\alpha$  Ari and  $\alpha$  Per) have been measured for radial velocities, using spectra taken at the Asiago Observatory with a dispersion of  $40\text{\AA}/\text{mm}$  at  $H\gamma$ . Velocities of  $-15 \pm 1 \text{ kms}^{-1}$  and  $+5 \pm 2 \text{ kms}^{-1}$  have been obtained for  $\alpha$  Ari and  $\alpha$  Per respectively. The result is very encouraging.

The time required by the reduction program obviously varies with the length of the scanned spectrum. For the two above mention stars (K-type), 1 cm of comparison spectrum plus 1 cm of stellar spectrum have been reduced in about 12 min. The plot of a part of the spectrum of  $\alpha$  Ari is shown in Figure 20.

## DISCUSSION

K. NANDY: Do you measure density or intensity?

L. GRATTON: What you actually register is the response of the electrometer. This is a normal microphotometer with converging light, so it is a kind of compromise between density and intensity.

K. NANDY: Then you need calibration?

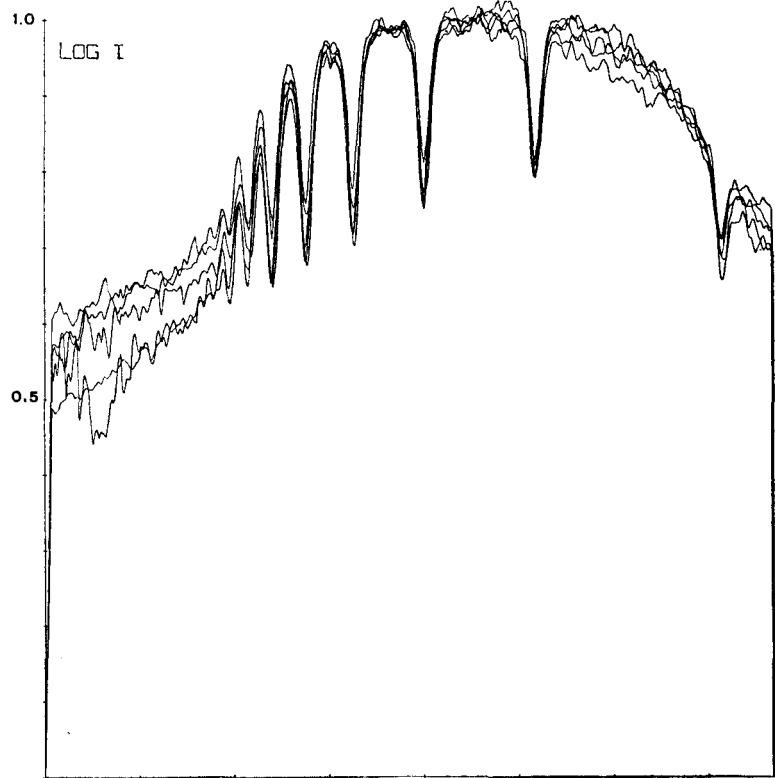

Fig. 18

Five objective-prism spectra of  $\alpha$  Lyrae.

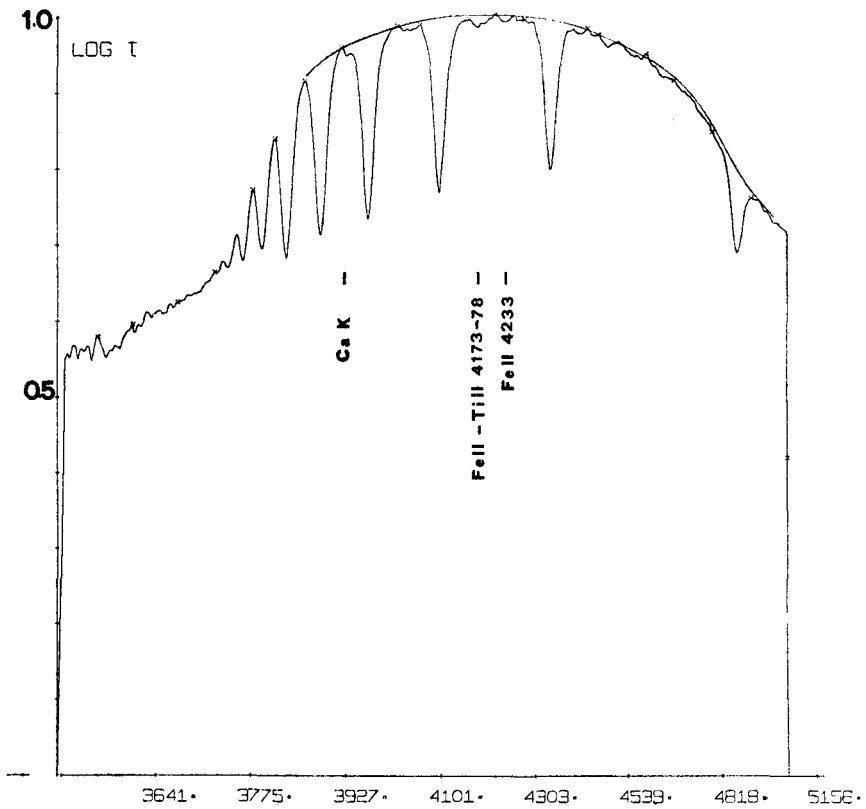

Fig. 19

The averaged spectrum of  $\alpha$  Lyrae and line identification: Log I against wavelength.

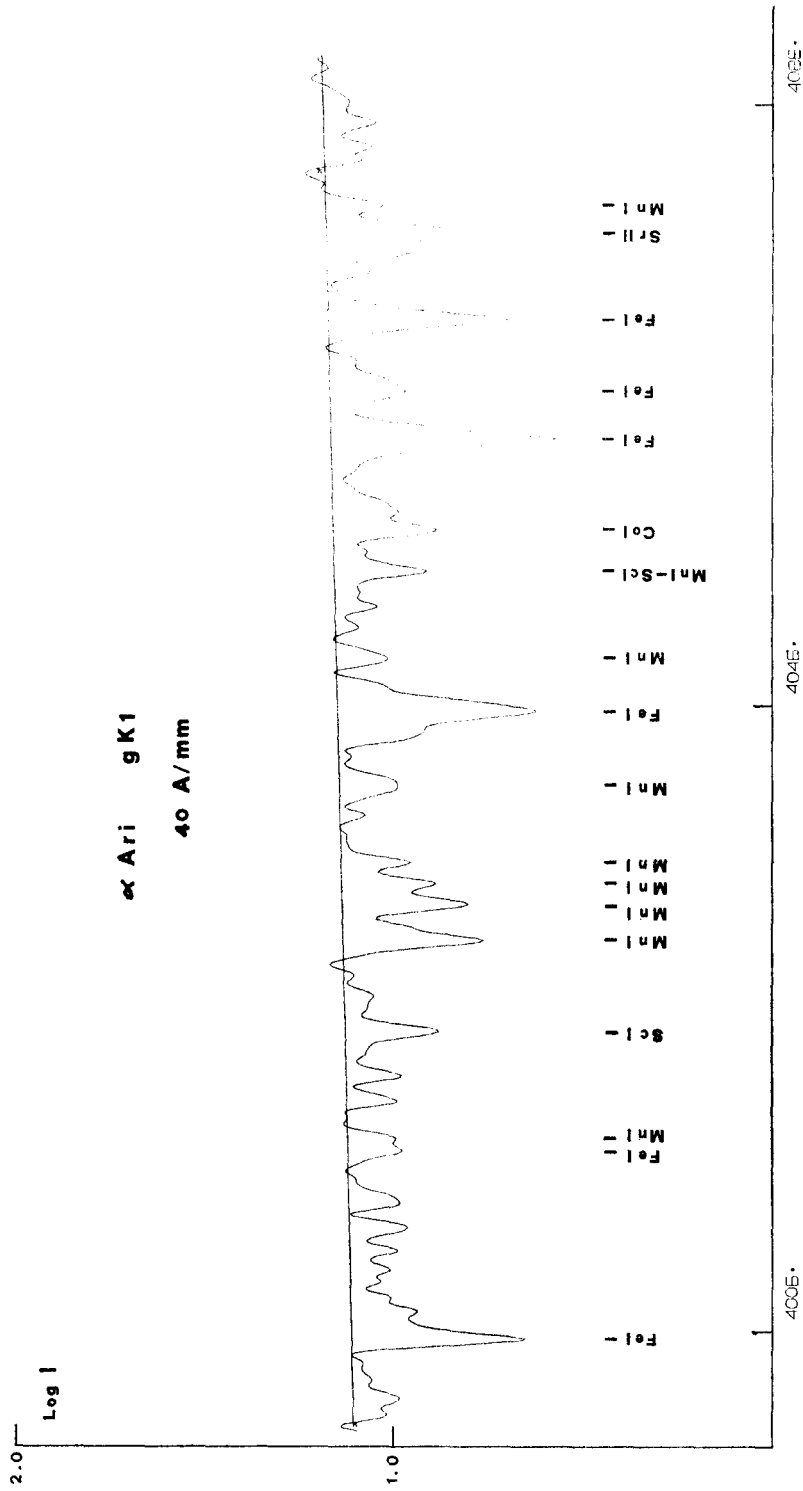

Fig. 20  
Intensity tracing and line identification of a portion of an intermediate dispersion spectrum of a K-type star ( $\alpha$  Ari) obtained with the 120 cm telescope of the Asiago Observatory.

L. GRATTON: We use standard microphotometric techniques. We did not aim to have a different system from the normal one, which has been already used for so many years quite satisfactorily by all astronomers, but simply to speed up all the operations.

P. J. TREANOR: I imagine that the use of combined unbroadened objective-prism spectra will present a difficult problem of intensity calibration; have you given consideration to this point?

L. GRATTON: In all kinds of work you have to compromise between high accuracy and a large amount of information. If you want a very large amount of information, then I don't think that it is possible to aim at the same time for very high accuracy. In this case the idea was to handle a large number of plates, both objective-prism and normal spectrograph; hence one must not be too exigent concerning accuracy.