

Edinburgh Mathematical Society.

LIST OF MEMBERS.

TWENTY-FIFTH SESSION 1906-1907.

- 1 V. RAMASWAMI AIYAR, M.A., Deputy Collector, Arni, India
ROBERT J. ALEY, Professor of Mathematics, Indiana University,
Bloomington, Indiana, U.S.A.
JOHN ALISON, M.A., F.R.S.E., Headmaster, George Watson's
College, Edinburgh
R. E. ALLARDICE, M.A., Professor of Mathematics, Leland-
Stanford Junior University, Palo Alto, California
- 5 WM. ANDERSON, M.A., F.R.S.E., George Watson's College,
Edinburgh
JAMES ARCHIBALD, M.A., F.R.S.E., 52 Polwarth Gardens,
Edinburgh (*President*)
LOUDON ARNEIL, M.A., U.F. Training College, Glasgow
M. V. ARUNACHALAM, M.A., The Nizam College, Hyderabad
PAUL AUBERT, Professeur au Lycée Charlemagne, Paris
- 10 A. J. GUNION BARCLAY, M.A., F.R.S.E., High School, Glasgow
J. C. BEATTIE, D.Sc., F.R.S.E., Professor of Applied Mathe-
matics and Experimental Physics, South African College,
Cape Town
ROBT. J. T. BELL, M.A., B.Sc., 90 Barrington Drive, Glasgow
PETER BENNETT, Glasgow and West of Scotland Technical
College, Glasgow
EDWARD BLADES, M.A., B.Sc., George Watson's Ladies' College,
Edinburgh
- 15 JAMES BOLAM, Leith Nautical College, Leith
Professor T. J. G'A BROMWICH, M.A., Queen's College, Galway
R. R. BRODIE, Scottish Provident Institution, St Andrew
Square, Edinburgh
A. BROWN, M.A., B.Sc., Professor of Applied Mathematics,
South African College, Cape Town
H. H. BROWNING, M.A., 128 Byres' Road, Glasgow
- 20 J. BRUCE-KINGSMILL, R.A., Compton Mount, Compton,
Winchester
JAMES BUCHANAN, M.A., 9 St Andrew Square, Edinburgh

- A. G. BURGESS, M.A., F.R.S.E., Ladies' College, Queen Street,
Edinburgh
- J. W. BUTTERS, M.A., B.Sc., F.R.S.E., Rector, The Academy,
Ardrossan
- JOHN F. CAMERON, M.A., Fellow and Tutor of Caius College,
Cambridge
- 25 JOHN CAMPBELL, B.Sc., Allan Glen's School, Glasgow
- GEORGE A. CARSE, M.A., B.Sc., Lecturer on Natural Philosophy,
The University, Edinburgh
- HORATIO S. CARSLAW, M.A., D.Sc., F.R.S.E., University,
Sydney, Australia
- CHARLES CHREE, M.A., D.Sc., F.R.S., 25 Mount Ararat Road,
Richmond, Surrey
- GEORGE CHRYSAL, M.A., LL.D., Sec. R.S.E., Professor of
Mathematics, University, Edinburgh (*Hon. Member*)
- 30 J. B. CLARK, M.A., F.R.S.E., George Heriot's School, Edinburgh
- PETER COMRIE, M.A., B.Sc., Boroughmuir School, Edinburgh
- G. E. CRAWFORD, M.A., Manor House, Clifton, Bristol
- LAWRENCE CRAWFORD, M.A., D.Sc., Professor of Mathematics,
South African College, Cape Town
- R. F. DAVIS, M.A., Burlington Avenue, Kew Gardens,
London, W.
- 35 J. MACALISTER DODDS, M.A., Peterhouse, Cambridge
- A. C. DIXON, M.A., F.R.S., Professor of Mathematics, Queen's
College, Belfast
- JAMES M. DOGGART, B.A., Kirkcaldy High School
- J. A. DOIG, George Watson's College, Edinburgh
- A. GRAHAM DONALD, M.A., F.F.A., Scottish Provident
Institution, Edinburgh
- 40 CHAS. S. DOUGALL, M.A., Rector, The Institution, Dollar
- JOHN DOUGALL, M.A., Kippen, Stirlingshire
- ALBERT DRIVER, George Watson's College, Edinburgh
- DAVID DRYSDALE, M.A., Royal Academy, Irvine
- JOHN DUNBAR, M.A., B.Sc., The Academy, Ardrossan
- 45 GEORGE DUTHIE, M.A., B.A., F.R.S.E., Superintending
Inspector of Schools and Statist, Salisbury, Rhodesia
- Professor JAMSHEDJI EDALJI, 30 Tani Machi, Ushigome Ku,
Tokyo, Japan
- GEORGE EDNIE, M.A., B.Sc., The Academy, Dumfries
- JAMES M. EDWARD, M.A., Headmaster, Wigtown
- JOHN EDWARDS, M.A., The Academy, Ardrossan
- 50 JAS. ERSKINE-MURRAY, D.Sc., 2 Crown Gardens, Glasgow
- R. M. FERGUSON, Ph.D., LL.D., F.R.S.E., 5 Douglas Gardens,
Edinburgh
- JAMES FINDLAY, 11 Morningside Gardens, Edinburgh
- WM. FINLAYSON, 84 Pilrig Street, Edinburgh
- Rev. NORMAN FRASER, B.D., 84 Craiglea Drive, Edinburgh

- 55 W. G. FRASER, M.A., H.M.I.S., 22 Duke Street, Edinburgh
 JAMES M. FREW, M.A., B.Sc., 17 Highburgh Road, Dowanhill,
 Glasgow
 J. D. FULTON, M.A., B.Sc., Physical Laboratory, The Uni-
 versity, Edinburgh
 ALEXANDER H. GARDNER, M.A., B.Sc., Headmaster, Lochgilphead
 WM. GENTLE, B.Sc., George Heriot's School, Edinburgh
- 60 H. T. GERRANS, M.A., Fellow and Tutor of Worcester College,
 Oxford
 GEORGE A. GIBSON, M.A., LL.D., Professor of Mathematics,
 West of Scotland Technical College, Glasgow (*Hon. Member*)
 JAMES GOODWILLIE, M.A., B.Sc., Lecturer on Mathematics,
 King's College, Aberdeen
 GEORGE GREEN, M.A., 3 Edgefauld Terrace, Springburn,
 Glasgow
 W. J. GREENSTREET, M.A., Headmaster, Marling School, Stroud
- 65 P. S. HARDIE, M.A., B.Sc., Ras-el-tin, Government School,
 Alexandria, Egypt
 R. P. HARDIE, M.A., Assistant to the Professor of Logic,
 University, Edinburgh
 J. HARKESS, M.A., B.Sc., Physical Laboratory, The University,
 Edinburgh
 E. W. HERBERT, M.A., The Academy, Edinburgh
 WM. HISLOP, M.A., The Academy, Rothesay
- 70 ALEX. HOLM, M.A., Girls' High School, Glasgow
 JAMES HORNE, George Watson's College, Edinburgh
 E. M. HORSBURGH, M.A., B.Sc., A.M.I.C.E., Lecturer in
 Mathematics, The University, Edinburgh
 W. R. HUGHES, B.A., Fellow of Jesus College, Cambridge
 PETER D. INNES, M.A., B.Sc., 9 Park Street, Cambridge
- 75 JOHN JACK, M.A., Professor of Mathematics, Wilson College,
 Bombay
 W. JACK, M.A., LL.D., Professor of Mathematics, University,
 Glasgow (*Hon. Member*)
 Rev. FRANK H. JACKSON, M.A., R.N., Chaplain and Naval
 Instructor, H.M.S. "Acheron," Chatham
 H. A. JAMIESON, M.A., The Academy, Ayr
 JOHN JEFFREY, M.A., B.Sc., Rector, High School, Selkirk
- 80 WM. JEFFREY, M.A., Academy, Banff
 GEORGE JOHNSTON, M.A., Spier's School, Beith
 D. M. JOHNSTONE, M.A., B.Sc., George Heriot's School,
 Edinburgh
 ARCHIBALD KING, M.A., B.Sc., Rector, The Academy, Castle-
 Douglas
 LORD KELVIN, LL.D., D.C.L., F.R.S., P.R.S.E., etc., Netherhall,
 Largs (*Hon. Member*)
- 85 JOHN W. KIPPEN, Headmaster, St Andrew's School, Dundee

- CARGILL G. KNOTT, D.Sc., F.R.S.E., Lecturer on Applied Mathematics, University, Edinburgh
- ARCHIBALD LANG, M.A., B.Sc., H.M.I.S., 21 Cartha Street, Langside, Glasgow
- P. R. SCOTT LANG, M.A., B.Sc., F.R.S.E., Professor of Mathematics, University, St Andrews
- W. S. LAURIE, M.A., 7 Marine Terrace, Waterloo, Blyth, Northumberland
- 90 GEORGE LAWSON, M.A., Rector, Waid Academy, Anstruther
- R. LEES, M.A., B.Sc., Headmaster, The Academy, Fraserburgh
- G. M. K. LEGGETT, Sir John Cass Technical Institute, Aldgate, E.C.
- ALEXANDER LEIGHTON, M.A., B.Sc., Morgan Academy, Dundee
- WM. A. LINDSAY, M.A., B.Sc., U.F. Church Training College, Glasgow (*Vice-President*)
- 95 JAMES LITTLEJOHN, M.A., 11 Kinnaird Street, Arbroath
- ALEX. V. LOTHIAN, M.A., B.Sc., F.R.S.E., Mathematical and Science Lecturer, E.C. Training College, Glasgow
- J. BARRIE-LOW, M.A., Wrenschtown House, Observatory Road, Cape Town
- WM. H. LOVE, M.A., U.F. Training College, Glasgow
- JOHN H. M'ALPINE M.I.N.A., 615 Walnut Street, Philadelphia
- 100 NEIL M'ARTHUR, M.A., B.Sc., The University, Glasgow
- JAMES A. M'BRIDE, B.A., B.Sc., Allan Glen's School, Glasgow
- JAS. M'CUBBIN, B.A., F.R.S.E., Rector, The Academy, Kilsyth
- JAMES A. MACDONALD, M.A., B.Sc., F.R.S.E., H.M.I.S., Dingwall, N.B.
- W. J. MACDONALD, M.A., F.R.S.E., Daniel Stewart's College, The Dean, Edinburgh
- 105 D. C. M'INTOSH, M.A., B.Sc., F.R.S.E., Ladies' College, Queen Street, Edinburgh
- J. S. MACKAY, M.A., LL.D., F.R.S.E., 69 Northumberland Street, Edinburgh (*Hon. Member*)
- ANGUS M'LEAN, B.Sc., C.E., Principal, Technical College, Paisley
- CHARLES M'LEOD, M.A., D.Sc., Aberdeen Grammar School
- PETER M'LEOD, M.A., B.Sc., Hillhead High School, Glasgow
- 110 JESSIE CHRYSTAL MACMILLAN, M.A., B.Sc., Corstorphine Hill, House, Edinburgh
- D. S. M'Nair, B.Sc., Ph.D., H.M.I.S., 67 Braid Avenue, Edinburgh
- ARTEMAS MARTIN, M.A., Ph.D., LL.D., U.S. Coast Survey Office, Washington, D.C., U.S.A.
- JEAN MATTHEW, M.A., c/o Mrs Lilico, 130 Marchmont Road, Edinburgh
- J. B. MEIKLEJOHN, M.A., High School, Dundee

- 115 JOAQUIN DE MENDIZABAL Y TAMBORREL, Professor de Mathématique, Palma, 13 Mexico
 ALEX. J. MERRILEES, M.A., B.Sc., 12 Marchmont Street, Edinburgh
 W. J. MILLAR, C.E., late Secretary, Instit. Engineers and Shipbuilders in Scotland, 31 Marine Place, Rothesay
 JOHN MILLER, M.A., West of Scotland Technical College, Glasgow
 T. HUGH MILLER, M.A., D.Sc., Training College, Isleworth, near London
- 120 WILLIAM MILLER, M.A., 48 Windsor Terrace, St George's Road, Glasgow
 ARCH. MILNE, M.A., B.Sc., F.R.S.E., E.C. Training College, Edinburgh
 HUGH MITCHELL, High Losset Farm, Machrihanish
 JAMES MITCHELL, M.A., B.Sc., F.R.S.E., The Academy, Kilmarnock
 GEORGE L. MOFFAT, M.A., B.Sc., The Academy, Glasgow
- 125 ALEXANDER MORGAN, M.A., D.Sc., F.R.S.E., Principal, Church of Scotland Training College, Edinburgh
 ELIZABETH MORRISON, M.A., 23 Brisbane Street, Greenock
 J. T. MORRISON, M.A., B.Sc., F.R.S.E., Professor of Physics, Stellenbosch, Cape Colony
 THOMAS MUIR, M.A., LL.D., F.R.S., F.R.S.E., C.M.G., Superintendent-General of Education, Mowbray Hall, Rosebank, Cape Colony
 R. FRANKLIN MUIRHEAD, M.A., D.Sc., 64 Great George Street, Hillhead, Glasgow
- 130 ASUTOSH MUKHOPADHYĀY, M.A., LL.D., F.R.A.S., F.R.S.E., Professor of Mathematices, Bhowanipore, Calcutta
 DAVID MURRAY, M.A., B.Sc., Rector, The Academy, Kilmarnock
 A. M. C. MUTCH, M.A., B.Sc., Royal Academical Institution, Belfast
 M. T. NARANIENGAR, M.A., Professor of Mathematics, Central College, Bangalore, South India
 R. J. NICHOLSON, M.A., B.Sc., Boroughmuir H.G. School, Edinburgh
- 135 CHARLES NIVEN, M.A., D.Sc., F.R.S., Professor of Natural Philosophy, University, Aberdeen (*Hon. Member*)
 THOMAS NISBET, M.A., 4 Nisbet Street, Parkhead, Glasgow
 A. S. OGILVIE, M.A., B.Sc., E.C. Training College, Edinburgh
 R. T. OMOND, F.R.S.E., 3 Church Hill, Edinburgh
 W. M'F. ORR, M.A., Professor of Mathematics, Royal College of Science, Dublin
- 140 L. F. OTTO, M.A., Headmaster, Railway School, Thansi, U.P., India
 FRANK R. PEARSON, M.A., George Watson's College, Edinburgh

- WILLIAM PEDDIE, D.Sc., F.R.S.E., Professor of Physics, University College, Dundee
- GEORGE PHILIP, M.A., B.Sc., George Watson's College, Edinburgh
- WM. EDWARD PHILIP, M.A., H.M.I.S., Aberdeen
- 145 ROBERT PHILP, M.A., Hutcheson's Grammar School, Glasgow
- D. K. PICKEN, M.A., Lecturer and Assistant Professor, University, Glasgow (*Co-Editor*)
- P. PINKERTON, M.A., F.R.S.E., George Watson's College, Edinburgh (*Hon. Secretary*)
- R. H. PINKERTON, M.A., Professor of Mathematics, University College, Cardiff
- A. J. PRESSLAND, M.A., F.R.S.E., The Academy, Edinburgh
- 150 HARRY RAINY, M.A., M.D., F.R.S.E., 16 Great Stuart Street, Edinburgh
- PETER RAMSAY, M.A., B.Sc., Allan Glen's School, Glasgow
- THOS. T. RANKINE, C.E., B.Sc., Principal, Wigan and District Mining and Technical College, Wigan
- DAVID RENNETT, LL.D., 32 Fountainhall Road, Aberdeen
- JOHN ROBERTSON, B.Sc., Physical Laboratory, The University, Edinburgh
- 155 RICHARD D. ROBERTSON, M.A., Allan Glen's School, Glasgow
- A. J. ROSS, M.A., B.Sc., Gillespie's School, Edinburgh
- EDWARD B. ROSS, M.A., 3 Polwarth Gardens, Edinburgh
- PETER ROSS, M.A., B.Sc., Broughton H.G. School, Edinburgh
- ANDREW RUTLEDGE, B.A., 32 Clonmore Road, N. Strand, Dublin
- 160 ALEX. D. RUSSELL, B.Sc., High School, Falkirk
- K. T. SANGANA, Professor of Mathematics, Bhaonagar, Bombay
- CHARLOTTE ANGAS SCOTT, D.Sc., Professor of Mathematics, Bryn Mawr College, Pennsylvania, U.S.A.
- R. F. SCOTT, M.A., St John's College, Cambridge
- W. SCRIMGEOUR, M.A., B.Sc., 8 Bath Place, Ayr
- 165 RODERICK M. SHEARER, M.A., B.Sc., 28 Strathearn Road, Edinburgh
- EDWARD SMART, B.A., B.Sc., The Academy, Perth
- DUNCAN M. Y. SOMMERVILLE, M.A., D.Sc., Lecturer in Applied Mathematics, University of St Andrews
- FRANK SPENCE, M.A., B.Sc., F.R.S.E., U.F. Church Training College, Edinburgh
- T. B. SPRAGUE, M.A., LL.D., F.R.S.E., 29 Buckingham Terrace, Edinburgh
- 170 J. E. A. STEGGALL, M.A., Professor of Mathematics, University College, Dundee
- ALEX. STEVENSON, M.A., B.Sc., Whitehill School, Glasgow
- ADAM B. STEWART, M.A., The Ministry of Education, Darb-El-Gamamiz, Cairo, Egypt

- WALTER STEWART, M.A., D.Sc., H.M.I.S., 3 Coates Crescent,
Edinburgh
- LOUISA STORY, George Watson's Ladies' College, Edinburgh
- 175 WALTER STOTT, Hon. Sec. Liverpool Mathematical Society,
4 Grasmere Drive, Liscard
- DAVID G. TAYLOR, M.A., University College, Cardiff
- JAMES TAYLOR, M.A., F.R.S.E., The Academy, Edinburgh
- JOHN M. TAYLOR, B.A., Headmaster, E.C. Practising School,
Edinburgh
- W. S. TEMPLETON, M.A., B.Sc., Professor of Physics, Medical
and Technical Colleges, Colombo, Ceylon
- 180 J. A. THIRD, M.A., D.Sc., Spier's School, Beith
- H. F. THOMPSON, B.A., Academy, Edinburgh
- W. L. THOMPSON, M.A., B.Sc., Allan Glen's School, Glasgow
- JOHN GRAHAM THOMSON, 34 London Street, Edinburgh
- WM. THOMSON, M.A., B.Sc., LL.D., F.R.S.E., Registrar to the
Cape University, Cape Colony
- 185 W. L. THOMSON, M.A., George Heriot's School, Edinburgh
- JOHN TURNER, M.A., B.Sc., Royal High School, Edinburgh
(*Hon. Treasurer*)
- CHARLES TWEEDIE, M.A., B.Sc., F.R.S.E., Lecturer on Mathe-
matics, University, Edinburgh
- DAVID TWEEDIE, M.A., B.Sc., Ministry of Public Instruction,
Cairo, Egypt
- GEORGE D. VALENTINE, M.A., Advocate, 13 Pitt Street,
Edinburgh
- 190 ROBERT WALKER, M.A., U.F.C. Training College, Glasgow
- SAMUEL WALKER, M.A., D.Sc., George Heriot's School,
Edinburgh
- A. G. WALLACE, M.A., F.R.S.E., Headmaster, Central Public
School, Aberdeen
- W. WALLACE, M.A., F.R.S.E., Principal, Cockburn Science
School, Leeds
- W. G. WALTON, F.F.A., Scottish Provident Office, 6 St Andrew
Square, Edinburgh
- 195 JOHN C. WATT, M.A., Jesus College, Cambridge
- JAMES MACPHERSON WATTIE, M.A., B.A., H.M.I.S., Linton,
Strathern Road, Broughty-Ferry
- J. H. MACLAGAN-WEDDERBURN, M.A., 6 Succoth Gardens,
Edinburgh
- JOHN WEIR, M.A., Professor of Mathematics, Mysore, India
- WILLIAM WELSH, M.A., Jesus College, Cambridge
- 200 JOHN W. WHITE, B.A., Trinity Academy, Leith
- WM. WYPER, C.E., 10 Highbury Terrace, Downhill, Glasgow
- Rev. JOHN YOUNG, M.A., Whithorn, Wigtownshire
- W. YOUNG, F.F.A., Fidelity Mutual Insurance Company,
112-116 North Broad Street, Philadelphia, Pa, U.S.A.

*The following Presents to the Library have been received,
for which the Society tenders its grateful thanks.*

1. American Journal of Mathematics.
2. Bulletin of the American Mathematical Society.
3. Proceedings of the American Philosophical Society.
4. Annals of Mathematics.
5. Proceedings of the Cambridge Philosophical Society.
6. Proceedings of the Royal Society of Edinburgh.
7. Bulletin de la Société Mathématique de France.
8. Journal de Mathématique Élémentaire.
Publié par M. H. VUIBERT.
9. Bulletin de la Société Physico-Mathématique de Kasan.
10. Mémoires de la Société Royale des Sciences de Liège.
11. Proceedings of the London Mathematical Society.
12. Revista de la Real Academia de Ciencias exactas, físicas y naturales
de Madrid.
13. Memoirs and Proceedings of the Manchester Literary and Philo-
sophical Society.
14. Annales de la Faculté des Sciences de Marseilles.
15. Mathematical Gazette.
16. Nieuw Archief voor Wiskunde.
17. Rendiconti del Circolo Matematico di Palermo.
18. Annaes Scientificos da Academia Polytechnica do Porto.
19. Revue Semestrielle des Publications Mathématiques.
20. Proceedings of the Tôkyô Mathematico-Physical Society.
21. Nova Acta regiae Societatis Scientiarum Upsaliensis.
22. Bulletin of the Philosophical Society of Washington.
23. Wiskundige Opgaven met de Oplossingen.
24. Théorie des Probabilités continues, par M. L. BACHELIER.
25. Franklin Bicentennial Celebration. Philadelphia, 1906.

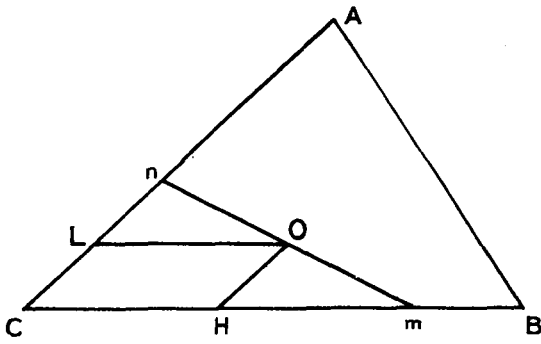

Fig. 1.

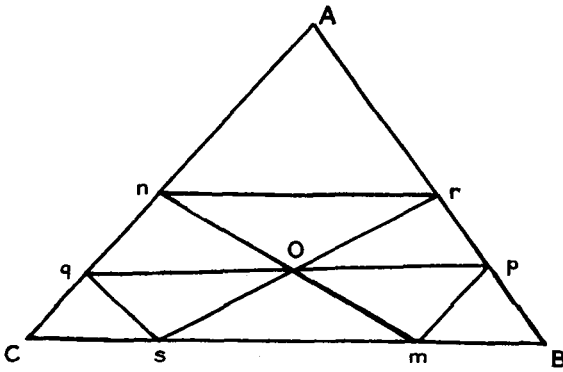

Fig. 2.

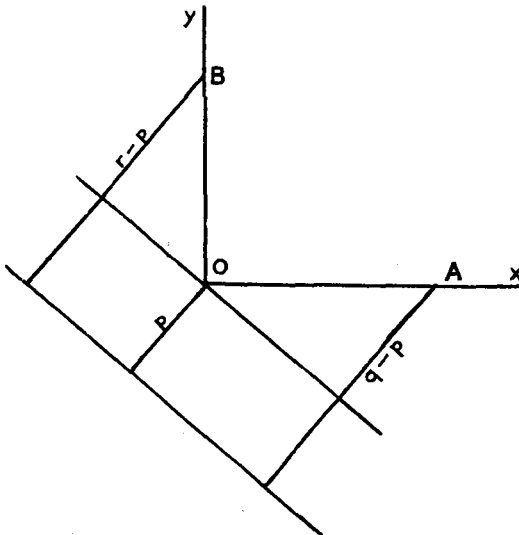

Fig. 3.

Fig. 4.

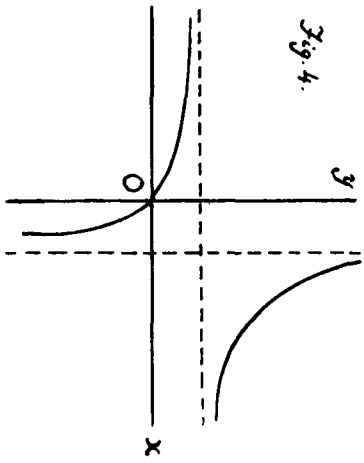

Fig. 5.

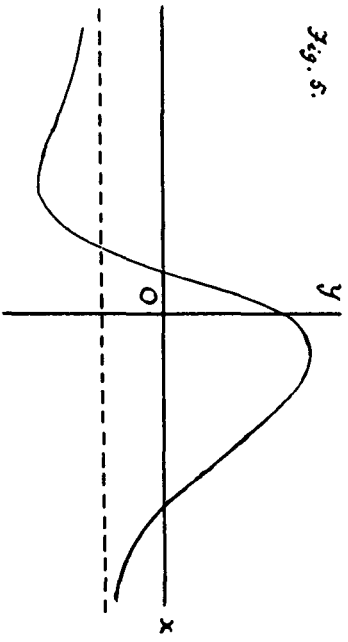

Fig. 6.

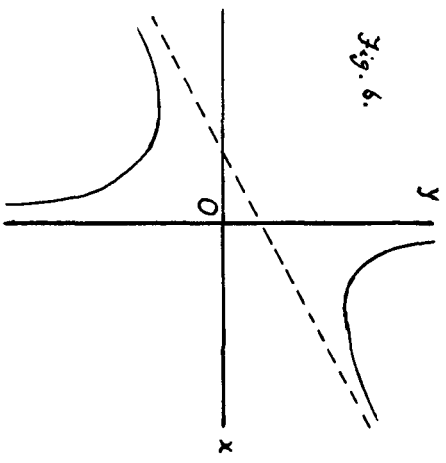

Fig. 7.

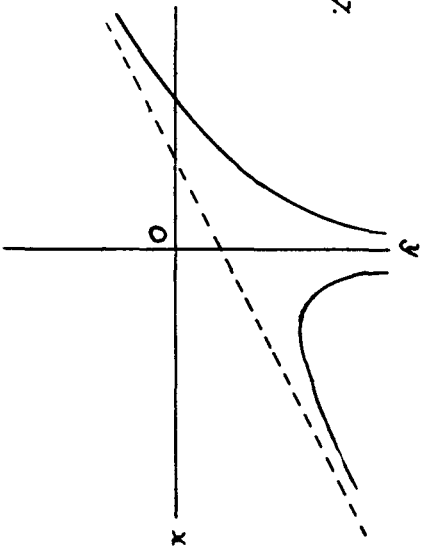

Fig. 8.

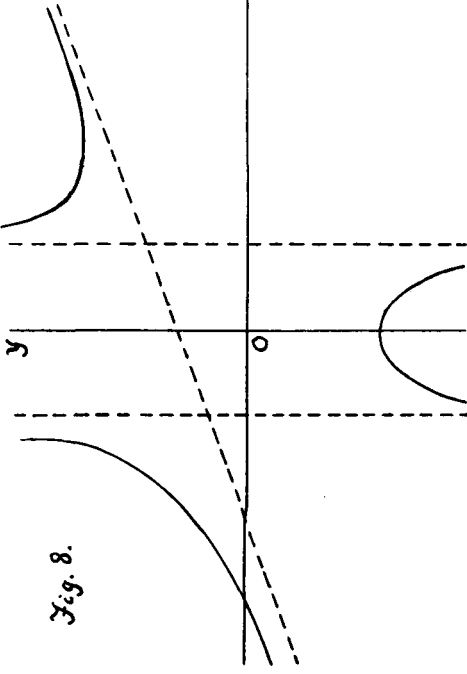

Fig. 10.

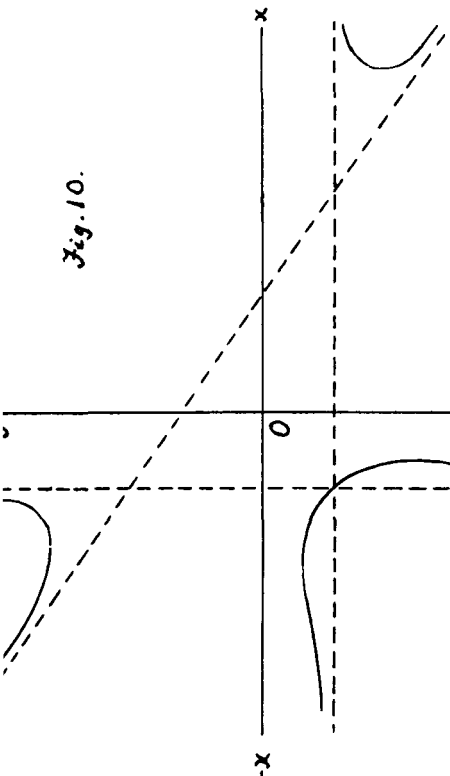

Fig. 9.

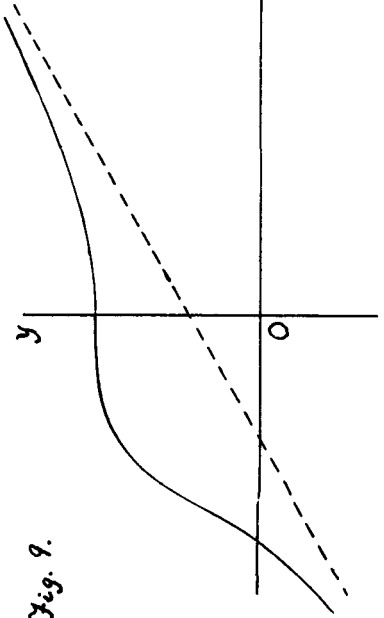
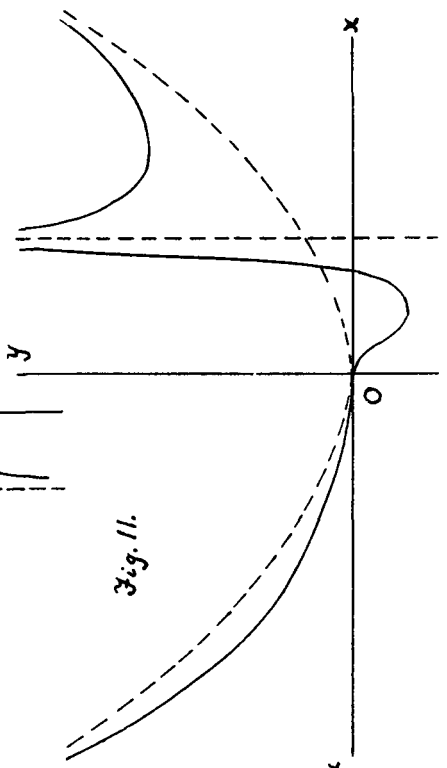

Fig. 11.



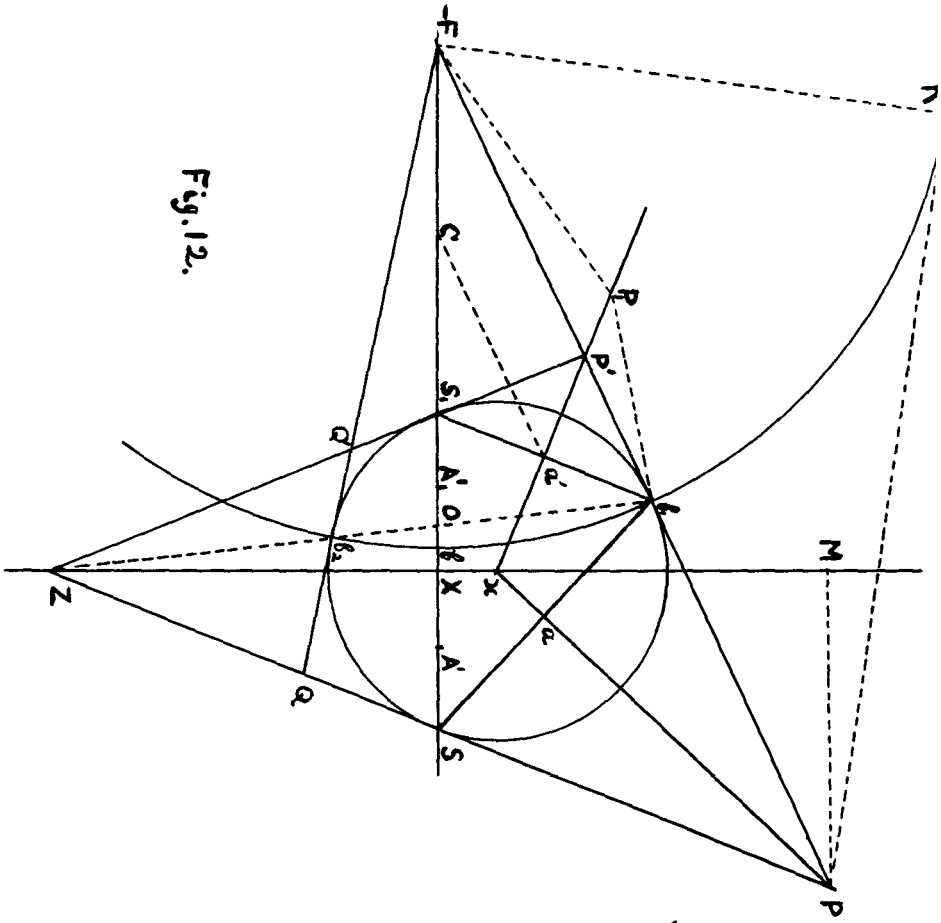

Fig. 12.

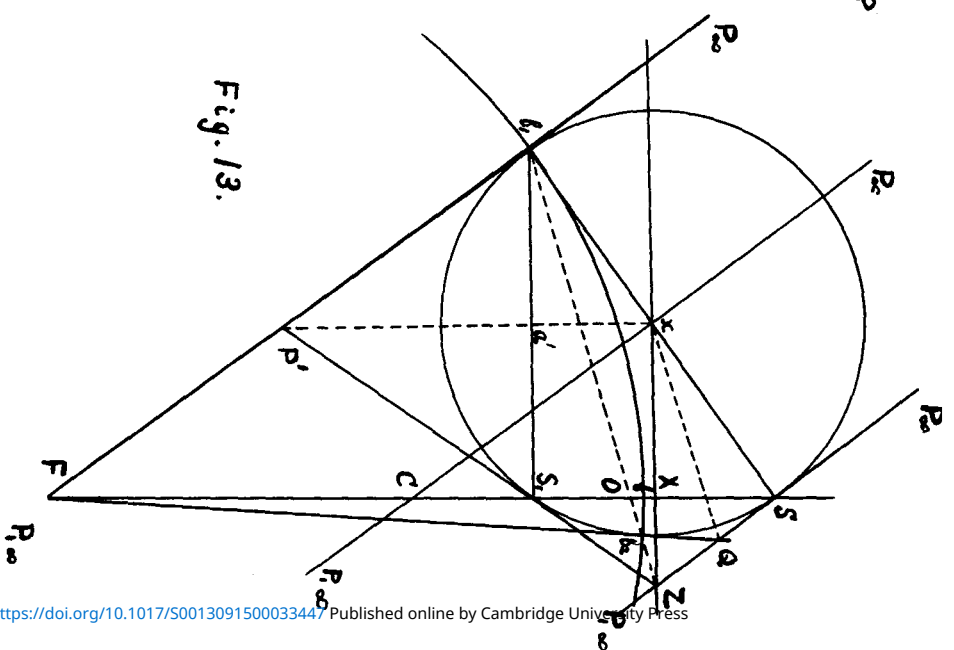
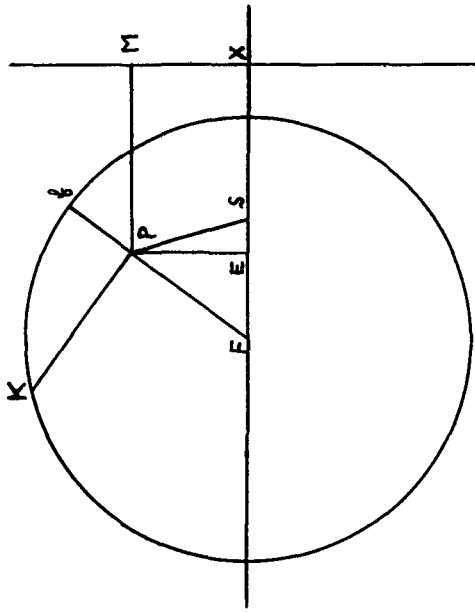
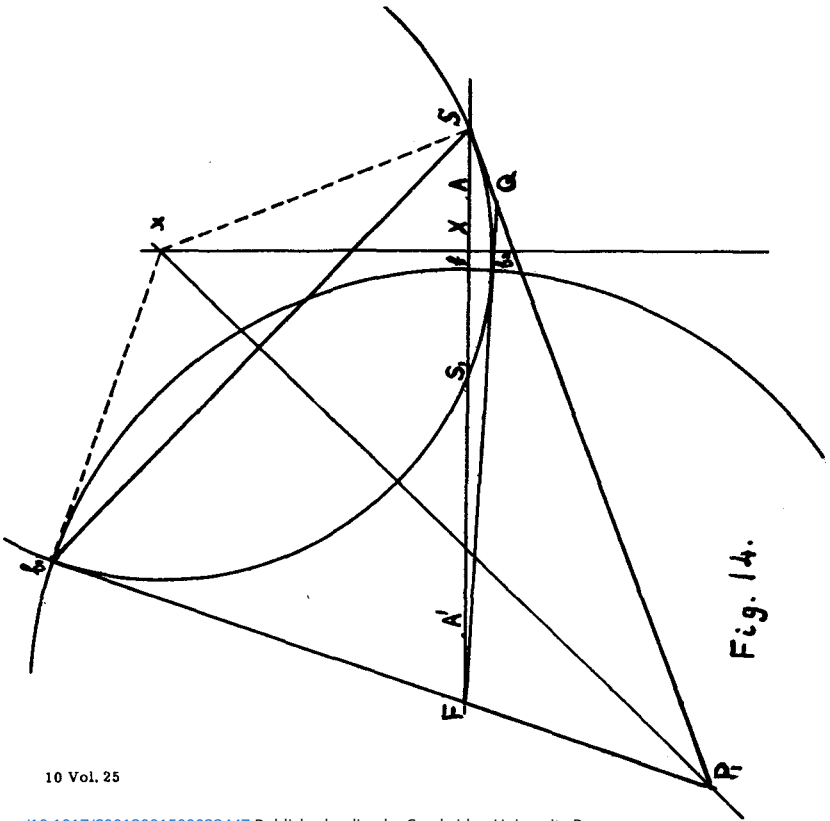

Fig. 13.



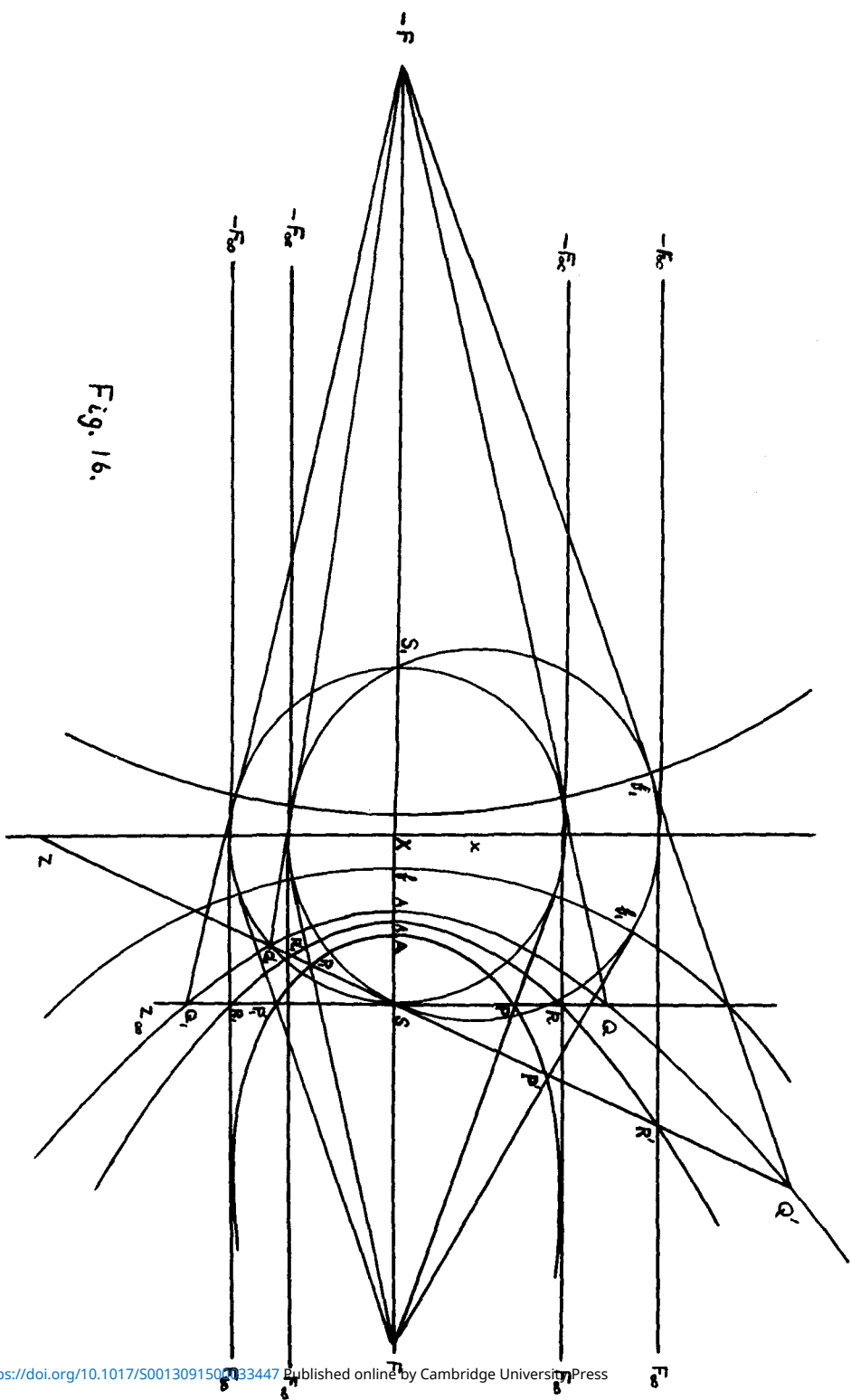

Fig. 16.

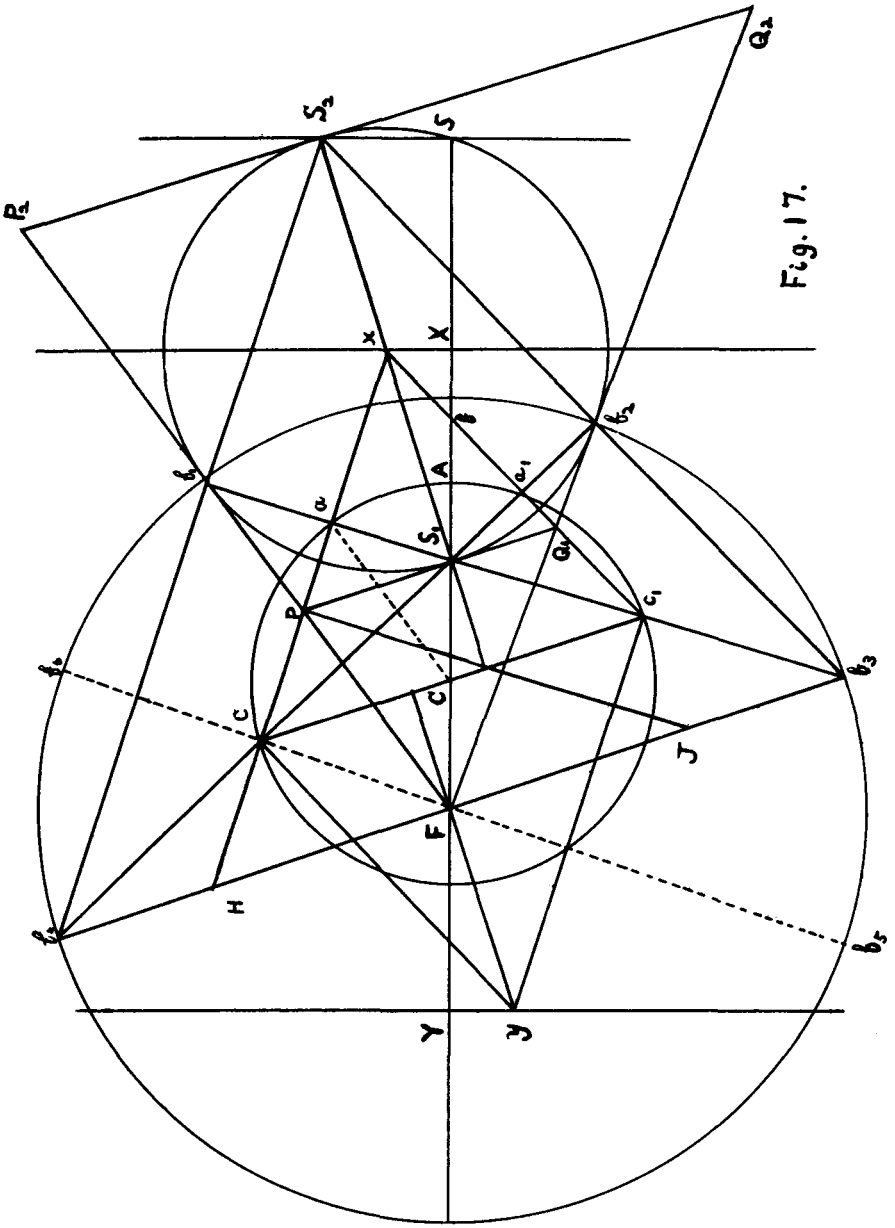

Fig. 17.

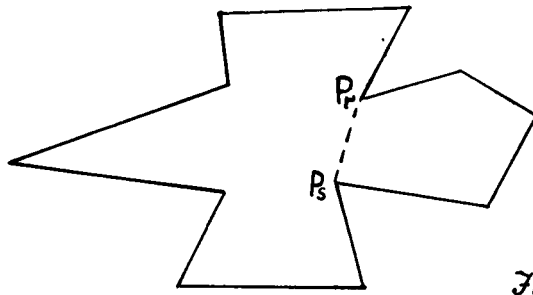

Fig. 18.

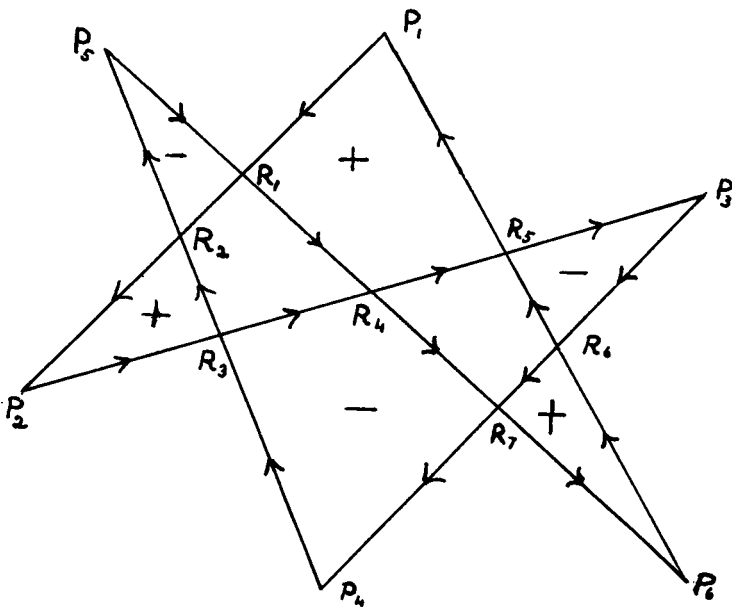

Fig. 19.

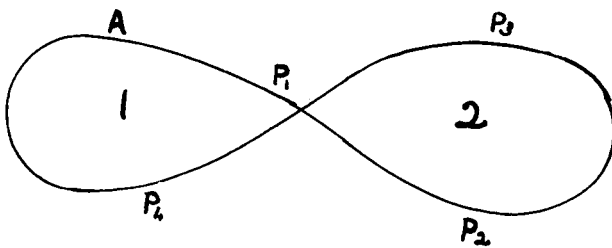

Fig. 20.

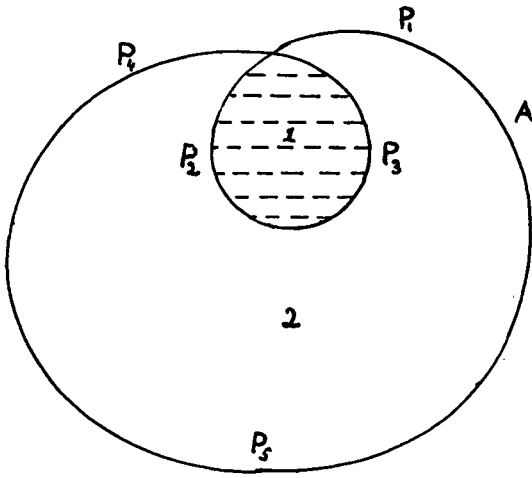

Fig. 21.

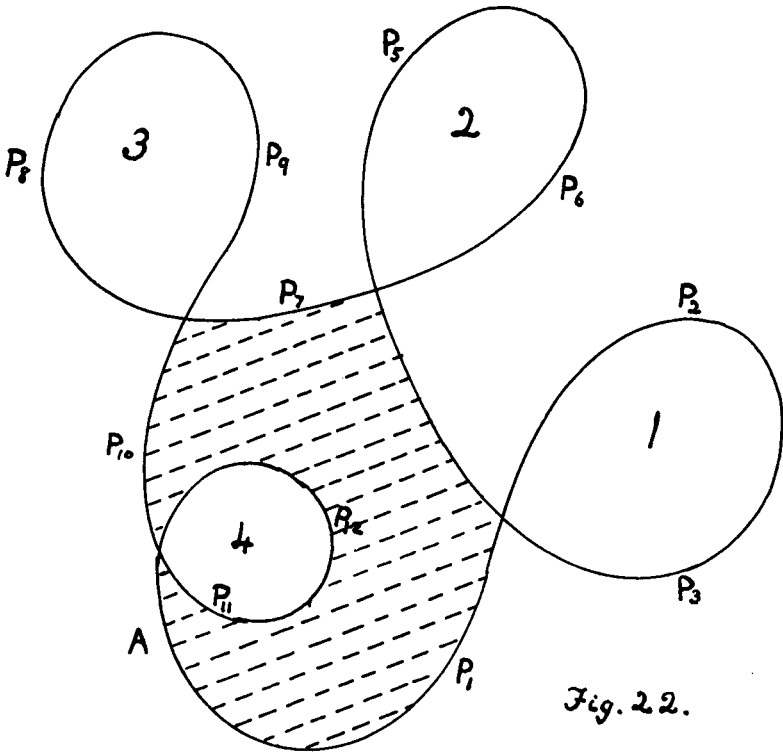

Fig. 22.

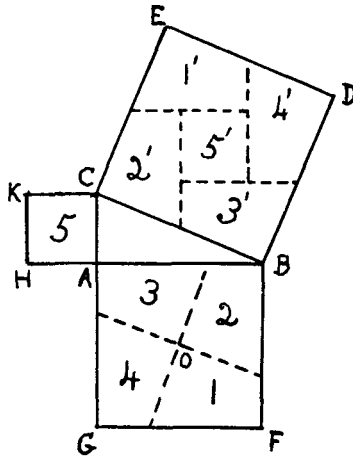

Fig. 23.

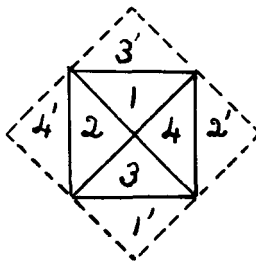

Fig. 24.

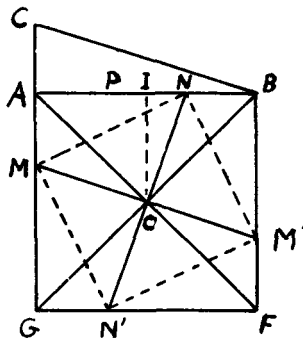

Fig. 25.