

THE DISINFECTION OF CLOSED ATMOSPHERES WITH GERMICIDAL AEROSOLS

BY C. C. TWORT, M.D., A. H. BAKER, S. R. FINN, B.Sc., A.I.C.
AND E. O. POWELL, B.A., B.Sc.

From Portslade Laboratories, Ltd., Portslade, Sussex

(With Plates VI-VIII and Fifty-four Text-figures)

CONTENTS

	PAGE
Introduction	253
1. Physical and chemical aspects. By S. R. FINN and E. O. POWELL	254
2. Bacteriological aspects. By A. H. BAKER	292
3. Tolerance tests. By C. C. TWORT	324
General discussion	337
Summary	340
General conclusions	341
References	343

INTRODUCTION

IT is now some seventy odd years since Lister (1868) introduced his carbolic spray into the operating theatre. It was gradually abandoned as surgeons became convinced that most surgical infections were due to bacteria introduced by the hands and instruments. In recent years the necessity for augmenting aseptic methods with precautions against air-borne infection has become recognized.

Trillat in France, Bechhold in Germany, and Wells and his colleagues in America have been interested in this problem, but no work had been published in this country until 1939 when Pulvertaft and his co-workers published two papers.

In March 1937 the opportunity was presented to us of commencing investigations on the prevention of air-borne infection. The outbreak of war has so disintegrated our team that we have been compelled to relinquish the research before full investigation of some important aspects could be undertaken. We feel, however, that it is desirable our results be published at the present stage in the hope that they may be of assistance to others interested in this subject.

The number of bacteria in the air may be reduced by several methods, but we decided to confine ourselves to the sterilization method employing germicidal mists or aerosols, so as to prevent the infection of any persons or objects which may happen to be present in a contaminated atmosphere.

So far we have been especially interested in direct bacterial infection through the nasal and oral cavities, but the methods we have employed should be

efficacious in combating other modes of infection, such as contact with contaminated objects. These methods should prove equally effective in veterinary and horticultural practice.

At an early stage of the enquiry it became evident that to obtain satisfactory results, co-ordinated animal, bacteriological, chemical, physical and mechanical investigations would be necessary, and these have been conducted simultaneously. In describing our work, we have, however, separated the animal, bacteriological, and physical and chemical sections, partly to simplify the descriptions and partly because in their practical applications they are likely to be of special interest to different persons.

In the presence of individuals suffering from certain contagious diseases the distribution of infective material in rooms is likely to be continuous. Consequently, we have attempted to find a germicide which is capable of being distributed as a very fine, persistent mist and which is very lethal to bacteria in particles of saliva suspended in the air, whilst it is not injurious, in the concentrations required to kill bacteria, to objects upon which it settles or to persons or animals exposed to it for long periods.

Up to the present we have not experimented with organisms pathogenic to man, but we have selected closely allied bacteria as test organisms, and we have succeeded in killing them with germicidal mists when suspended in the air, the mist concentrations required being apparently quite harmless to man. We believe that forms pathogenic to man would be killed with equal ease; the saprophytic bacteria normally present in the air are not, in general, so easily killed, but we are not primarily interested in these.

We have succeeded in overcoming most of the difficulties so far encountered, and feel that those arising in the practical application of this method to occupied rooms should not prove insurmountable.

1. PHYSICAL AND CHEMICAL ASPECTS

BY S. R. FINN AND E. O. POWELL

OBJECT OF THE WORK

In order to establish relations between their physical behaviour and their bactericidal potency, mists of various phenolic germicides in several solvents were studied by means of the ultramicroscope.

DESCRIPTION OF APPARATUS

The ultramicroscope was of similar pattern to that used by Siedentopf & Zsigmondy (1903) and Whytlaw-Gray, Speakman & Campbell (1922), but with certain modifications to make possible the continuous observation of a selected aerosol particle. The instrument, of which Fig. 1 shows a plan view, was made for us by Messrs R. and J. Beck, London. The final arrangement of the modifications referred to is shown diagrammatically in Figs. 2 and 3. The new cell (Fig. 3, *C*) was made from $\frac{1}{4}$ in. copper tubing with three cover-slip windows about 3×1 mm. This form of cell was adopted since it resulted in the contained particles being displaced exactly parallel to the axis of the cell when the air was moved. (With the

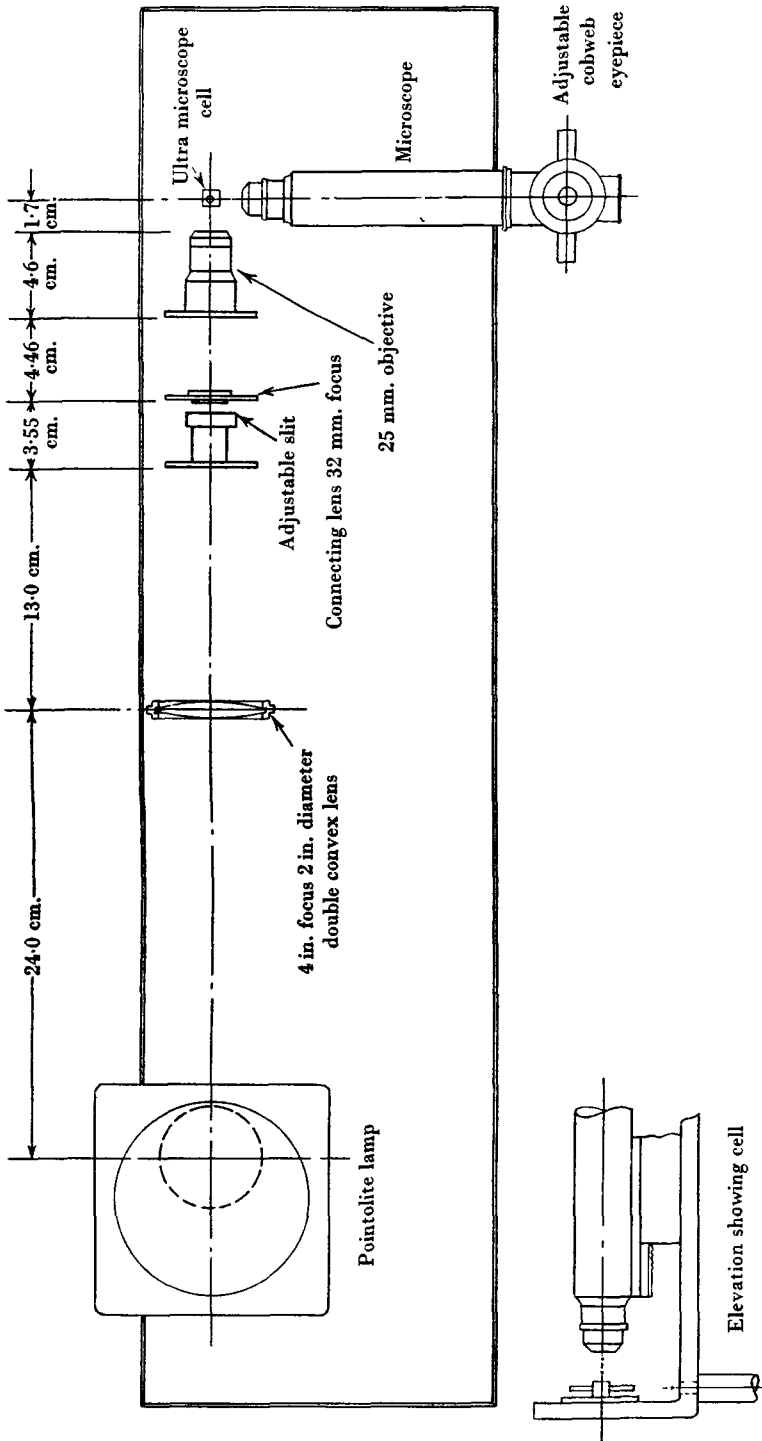

Fig. 1. Plan of ultramicroscope.

original cubic cell, which had very narrow leads, the stream lines were not rectilinear and particles did not remain in focus.) The bottom of the cell was connected by way of a three-way tap *A* to an aspirator for sampling, and to a displacing screw, *B*, with fine and coarse adjustment. To prevent the cell contents being disturbed by pressure transients, a loose-fitting cap *H* covered the upper end after a sample had been taken.

It was found necessary to adjust the cell accurately so that its axis lay in the plane perpendicular to the microscope's axis, in order that particles should not wander rapidly

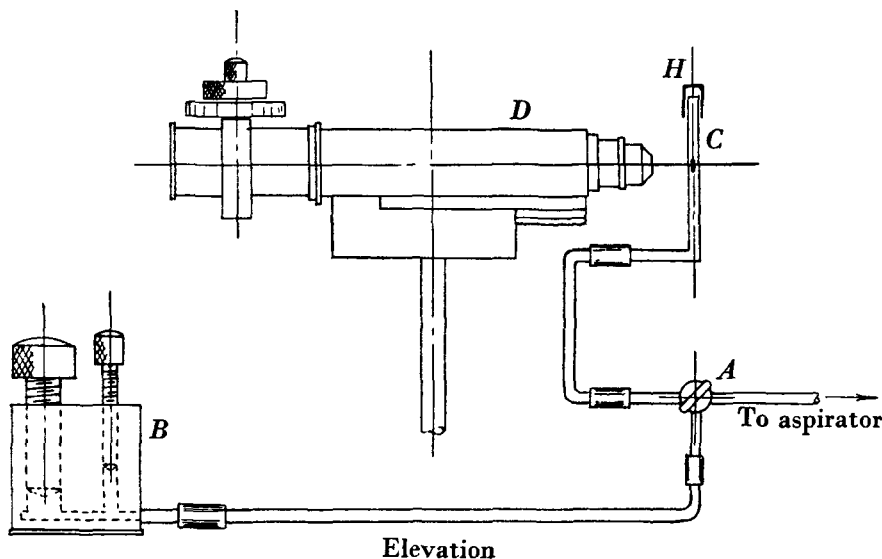

Fig. 2. Elevation of cell and displacing screw.

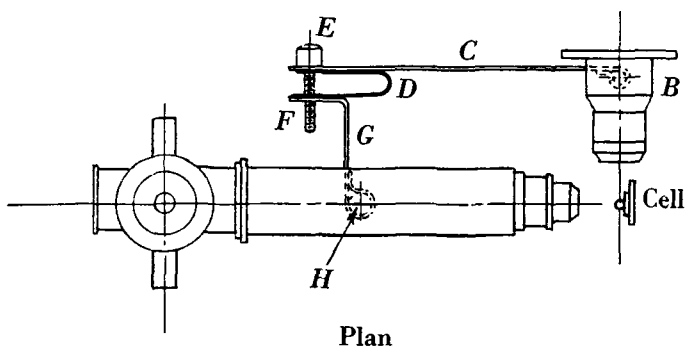

Fig. 3. Plan of light beam adjuster.

out of the light beam and out of focus. (The particle always falls vertically and is always restored to its former level along a line parallel to the cell's axis: if these two paths do not coincide a progressive horizontal displacement is produced by repetition of the process.) Sometimes, on account of photophoresis it was necessary to tilt the cell about the microscope axis, for a similar reason. The device shown in Fig. 3 was used to direct the light beam on to the particle under observation throughout its random Brownian motion. Since the amplitude of movement required was small, it was found sufficient to rotate the illuminating objective *B* about a vertical axis. The adjustment was made by means of a lever, screw and spring

(*C, E, D*). In general particles did not wander sideways out of the field by Brownian motion, once a correct adjustment of tilt had been made; when they did so a temporary readjustment brought them gradually back again.

A range of objectives from $2\frac{1}{2}$ to $\frac{1}{2}$ in. focal length was found sufficient to cover all requirements; the $\frac{1}{2}$ in. lens (Beck) was of specially long working distance. A quadruple nosepiece (not shown in figure) was fitted to the microscope barrel, both for convenience and to enable a high-power lens to be substituted for a lower as the size of a particle under observation diminished. (The change-over could only be made when there were very few particles in the field.) The micrometer eyepiece consisted of a fixed cross-wire and a movable one parallel to it, the distance between the two being measured on the graduated drum attached to the adjusting screw. The scale on the drum was calibrated for each of the objectives used by comparison with a stage micrometer. Usually the cross-wires were set 200 divisions of the scale apart; this represents a distance in the plane of the object ranging from 6.89×10^{-2} to 0.888×10^{-2} cm. with the objectives and nosepiece used, and about a quarter of a diameter of the observed field; thus there was ample space for observing the approach of particles about to be timed in their transit between the cross-wires.

THE EVAPORATION OF PARTICLES: TECHNIQUE

A sample of the mist under examination is drawn into the ultramicroscope cell by the aspirator; the cell is then connected to the displacing screws (Fig. 2, *B*) by the tap *A*, and the cap *H* put on, and as soon as the motion in the field has become steady as a whole, a particle is selected and its transit between the cross-wires timed. The particle is then kept in view by screwing down one or other of the displacing screws so that the air in the cell is moved gently upwards against the direction of fall of the particle. After a convenient time, usually 1 min. for a long-lived particle, the transit is retimed, the process being repeated until either the particle is too small to be seen or has wandered too far in a horizontal direction to be visible through the cell window. In the case of rapidly moving and slowly evaporating particles the amplitude of motion of the displacing screws is not great enough to give a sufficient movement of air in the cell for the whole determination. With practice, however, the particle can still be kept under observation by isolating the cell by means of a tap (Fig. 2, *A*) for a few seconds while the screws are turned back.

In order to prevent saturation of the air in the cell, and to minimize coagulation, only a very sparse mist is sampled. Nevertheless, the walls of the cell gradually become contaminated with the substances in use; then the air is always nearly saturated, and evaporation is suppressed. It is found necessary to wash out the cell and associated circuits with acetone or other pure volatile solvent after every few runs. When the solvent has been removed by a rapid current of air, the temperature in the cell is noticeably lowered, and must be allowed to rise to normal again before the cell is used, if convection currents are to be avoided.

The heat of the operator's hand near the displacing screw tends to introduce another error, due to slow expansion of the enclosed air. By keeping the hand in a fixed position during a series of determinations, little difficulty is encountered. When a drift in the field is actually present it can be detected by the reversal in the motion of the smallest particles present, and a correction deduced by timing their transits, since the correction is only required for particles travelling at higher speeds, i.e. at the beginning of a determination.

Timing is carried out on a single stop-watch. The watch is started at the instant of isolating a sample of mist, the atomizer being worked across the cell inlet; the sample is thus never more than 2 sec. old. The observer marks the transits of a selected particle by tapping, and the corresponding times are recorded by an assistant holding the stop-watch. The mean of initial and final times of a transit is taken as the particle's age corresponding to the velocity and hence radius calculated from the difference in these times.

Calculation

From the experimental figures for a given aerosol a set of tables and curves is prepared showing the variation of velocity with age for particles of different initial sizes. Table 1 is an example of one of such a set of tables. Fig. 4 shows a more complete set of curves for the evaporation of "Aéryl" (p. 271) droplets. Curve 1 in the upper graph corresponds to Table 1.

Table 1. *Evaporation of droplets—"Aéryl"*

Distance of fall of particle: 6.89×10^{-2} cm.

Age of particle sec.	Time of transit sec.	Velocity of fall cm./sec. $\times 10^3$
17	1.0	68.9
37	1.2	57.4
63	1.3	53.0
136	1.6	43.0
189	1.6	43.0
242	1.8	38.2
303	1.8	38.2
362	2.0	34.4
427	2.1	32.8
485	2.2	31.3
554	2.4	28.7
610	2.6	26.5
709	3.3	20.8
738	3.4	20.3
812	4.0	17.2
847	4.3	16.0
916	4.9	14.1
968	5.3	13.0
1029	6.8	10.1
1100	7.4	9.31
1160	9.3	7.40
1216	13.7	5.03
1282	18.2	3.78
1354	39.8	1.93
1425	90.0	0.765

The radius-age relation is calculated from the velocity-age curves so formed by the use of the Stokes-Cunningham relation (Cunningham, 1910):

$$V = \frac{2g}{9\eta} r^2 (\rho - \sigma) \left(1 + A \frac{L}{r} \right),$$

V = terminal velocity of fall, g = gravitational acceleration, η = viscosity of medium, r = radius of droplet, ρ = density of droplet, σ = density of medium (neglected), A = constant = 0.9, L = m.f.p. of medium molecules, whence

$$r = \frac{1}{2} \left\{ -AL + \sqrt{\left(A^2 L^2 + 18 \frac{\eta V}{\rho g} \right)} \right\}.$$

In this A , L , η and g are constant and we have

$$r = \frac{1}{2} \left\{ -9 \times 10^{-6} + \sqrt{\left(81 \times 10^{-12} + 3.16 \times 10^{-6} \frac{v}{\rho} \right)} \right\}.$$

A nomogram was therefore constructed from which could be read off the value of r corresponding to any value of v/ρ ; it was found convenient to use logarithmic scales on both axes.

From the set of velocity-age curves a number of abscissae (ages) were read off corresponding to a number of convenient ordinates (velocities) and from the chosen ordinates the radii were calculated. Table 2 gives the results of this operation on the values of Table 1 and Fig. 4 (upper graph, curve 1).

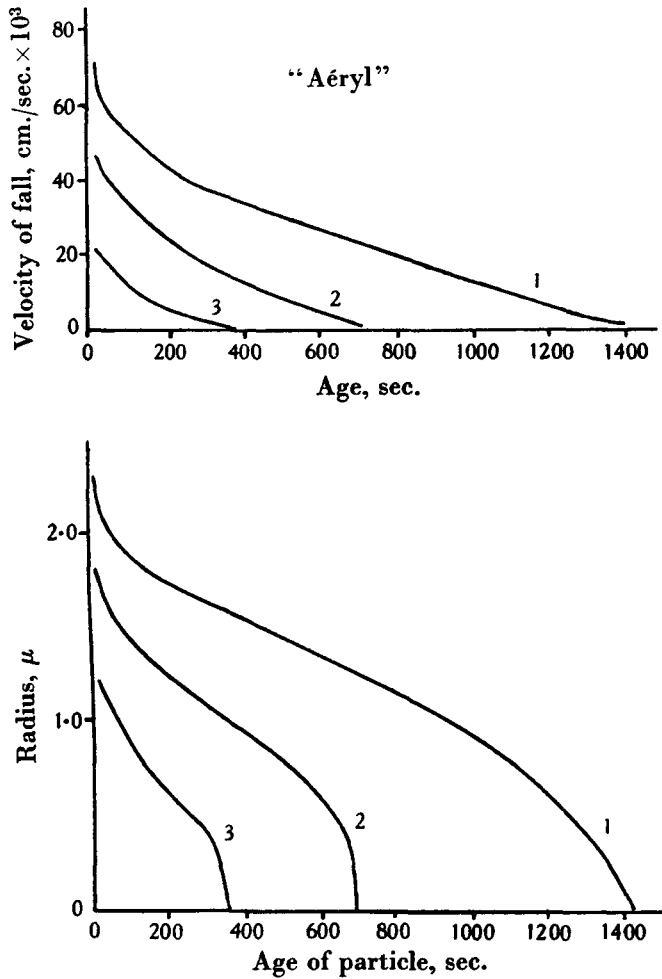

Fig. 4. Evaporation rate of "Aéryl".

(The lower set of curves in Fig. 4 gives the radius-age relations for "Aéryl" droplets and corresponds to the upper set of the same figure.)

Table 2. *Evaporation of droplets—“Aéryl”* ($\rho = 1.122$)

Age of particle sec.	Velocity of fall cm./sec. $\times 10^3$	$v/\rho \times 10^3$	$\text{Log}_{10} V/\rho$	$\text{Log}_{10} r$	r in μ
11	70	6.24	2.785	4.355	2.26
30	60	5.35	2.728	4.320	2.09
78	50	4.46	2.649	4.285	1.93
128	45	4.015	2.603	4.260	1.82
236	40	3.565	2.552	4.235	1.72
495	30	2.67	2.426	4.165	1.46
632	25	2.225	2.347	4.125	1.33
755	20	1.783	2.257	4.080	1.20
905	15	1.337	2.126	4.010	1.02
1050	10	0.892	3.950	5.920	0.83
1220	5	0.446	3.649	5.760	0.57
1335	2	0.178	3.251	5.540	0.35

EXPERIMENTAL RESULTS

During the determination of distribution curves in mists produced by the same atomizer with different working fluids (germicides), it was found possible to estimate qualitatively the relative volatility of different droplets by their persistence in the field of the ultramicroscope. As will be seen later (p. 306) a rough parallelism was noticed between droplet persistence and germicidal activity in air. These relations are expressed in Table 3.

Table 3

Solution	1	2	3	4
Volatility of solute	1 (max.)	2	3	4 (min.)
Persistence in field	4	3	2	1
Activity as aerosol	4	3	2	1
Rideal-Walker value	(low)	250	105	50

Solutions: 1 = propylene-glycol (alone).

2 = 4-*n*-amyl-3-hydroxy-toluene* (Coulthard, Marshall & Pyman, 1929).
10% W/W in propylene-glycol.

3 = 4-benzyl-3-hydroxy-toluene. 10% W/W in propylene-glycol.

4 = 4-*n*-hexyl-1:3-resorcinol. 10% W/W in propylene-glycol.

* The sample of amyl-*m*-cresol was kindly supplied by Messrs Boot's Pure Drug Company.

It was obvious that the physical behaviour of the aerosols was playing a much greater part than had previously been appreciated and that the Rideal-Walker value was probably of secondary importance.

In the more detailed investigation the evaporation of droplets of germicide solutions was followed. Benzyl-benzoate was chosen as a convenient standard solvent since it is itself reasonably persistent and is non-hygroscopic; the germicide solutions of practical application usually contained one or more substances which introduced complicating factors.

(Henceforth the *decrease* of velocity or radius with time ($-dv/dt$ or $-dr/dt$) will be called the slope or gradient of an evaporation curve.)

A number of pure substances was studied; these were benzyl-benzoate, glycerol, and four glycols, which were used by us as solvents for the germicidal phenols.

Benzyl-benzoate was found to follow the straight-line law of evaporation fairly closely (decrease of surface area with time = constant (Morse, 1910; Langmuir, 1918; Whytlaw-Gray & Patterson, 1932, p. 168)); there was no appreciable increase in curvature at the smallest radii, and the time of complete evaporation of a 1μ radius drop was estimated to be 1 min. 21 sec., in good agreement with Speakman & Sever's (Whytlaw-Gray & Patterson, 1932, p. 173) value of 1 min. 26 sec. (Fig. 5).

The behaviour of the polyhydroxy compounds was much more complex, and a thorough investigation could not be undertaken at this stage, especially as new experimental difficulties were encountered. The present remarks will therefore be of a semi-quantitative nature only.

Droplets of glycerol brought under observation within 1 sec. of their production by an atomizer, in the presence of fresh undried air, were seen to increase rapidly in size at first, presumably by absorption of water, and then remained comparatively stable. Only the smallest particles showed definite evidence of evaporation, and it was not possible to construct curves owing to the rapid fluctuation in velocity of fall, probably as a result of local humidity variation. The behaviour of aqueous solutions of glycerol is described below.

The following glycols were examined: ethylene, propylene (propan-1:2-diol), butylene (butan-2:3-diol), and pinacol (2:3-dimethyl-butan-2:3-diol). These all evaporated at a speed so surprisingly high considering their hygroscopicity that accurate timing was quite impossible. The stability followed the order of boiling points; a rough estimate of the time of evaporation of 2μ radius droplets was made:

Table 4

Substance	B.P.	Life
$C_2H_4(OH)_2$	197°	ca. 7 sec.
$C_3H_6(OH)_2$	188°	ca. 4 sec.
$C_4H_8(OH)_2$	ca. 181°	ca. 1 sec.
$C_6H_{12}(OH)_2$	171°	≤ 1 sec.

This gradation of persistence was very plainly demonstrated by a corresponding gradation in the length of the visible stream of mist issuing from the atomizer jet.

In the case of ethylene-glycol the very large droplets ($> ca. 3\mu$ radius) do not evaporate completely, but reach a minimum size, and after a subsequent small increase reach an equilibrium, in which condition they show no tendency to change during at least 20 min. (Fig. 6). This effect is to be ascribed to the absorption of water by the glycol, the tendency to increase in size due to absorption finally overtaking the decrease due to evaporation. De Forcrand (1901) showed that glycol on exposure to moist air (humidity not stated) took up water until the composition of the mixture corresponded to $C_2H_4(OH)_2 \cdot 2H_2O$, and it is possible that the stable droplets in glycol mists have this composition. But experiments of a similar kind to de Forcrand's with propylene-glycol, butylene-glycol and glycerol, show that they take up approximately $1\frac{1}{2}$, $1\frac{1}{3}$, and 2 molecules of water respectively, in air at 75% humidity, and the compositions of the liquids formed vary with changes in humidity. On the other hand, pinacol is known to form a stable hydrate, $6H_2O$.

Smaller droplets of ethylene-glycol and all observable droplets of the other three liquids evaporate to a size below the limits of visibility (approx. 0.06μ), but apparently nuclei remain, for after a short time, particles reappear, and remain stable, except in the case of pinacol where these secondary particles re-evaporate in 2-3 min.

In view of the very small limiting sizes reached these effects might be ascribed to coagulation, were it not that they were observed in mists so dilute that only a few particles were visible in the microscope field, and that a similar effect has not been observed in dilute fields with other substances. Neither do they seem to depend upon the mist concentration.

When the relative humidity of the air was low and the atmosphere in the ultramicroscope cell already partially saturated, it was found just possible to make a few observations on large droplets of propylene-glycol during their initial phase (Fig. 7). They evaporate and pick up water in the same way as does ethylene-glycol. The secondary particles are less persistent, however.

Fig. 8 is an interesting example of the effect of coagulation in a very dense mist containing a large number of fine droplets. By repeated collision with much smaller ones, each of the observed droplets appeared to increase in size gradually, the differences in velocity produced at each collision being generally, but not always, too small to be distinguished from possible experimental error. Occasionally larger changes in velocity were found (Fig. 8, curve 2) and a few collisions which took place in the focal plane between the observed particles and others of comparable size were actually noticed (Fig. 8, inset). It will be seen that the increase in size of the different droplets follows no regular law, the shape of the curve being different for each. The effect is therefore not entirely due to distillation from particle to particle (Tauzin, 1939).

Solutions of phenols in benzyl-benzoate

Three germicides, representative of three classes of biological behaviour were examined in 10% W/W solution in benzyl-benzoate. These were: 4-*n*-amyl-3-hydroxy-toluene (R.W. 250) (Coulthard *et al.* 1929), benzyl-3-hydroxy-toluene (R.W. 105), and 4-*n*-hexyl-1:3-resorcinol (R.W. 50). These solutions were found to behave in a regular manner as expected, the mist persistence increasing in the order given. The respective evaporation curves are given in Figs. 9–11. The amyl-cresol solution evaporated, if anything a little faster than the pure solvent, the benzyl-cresol somewhat more slowly and the hexyl-resorcinol very much more slowly.

In the case of the amyl-cresol solutions the slope of the velocity-age curves I and II (Fig. 9) is a little greater at the beginning (not evident in the figure), and then becomes nearly equal to that for pure benzyl-benzoate, afterwards tailing off somewhat. With benzyl-cresol, this increased initial slope was not noticed and, according with the lower volatility, the tailing off is more prolonged. The initial slope of the curves for the hexyl-resorcinol solution is certainly a little greater than for the pure solvent, but it is not possible to say whether the long flat portion corresponds to the middle or end period of amyl-cresol droplets.

Since these solutions were atomized extremely readily, forming dense mists containing a high proportion of very small particles, it was difficult to take sufficiently dilute samples which were also fresh. Frequent cleaning of the microscope cell and repetition of determinations were necessary. (Fig. 11, curve I, is an example of the saturation often encountered.)

Benzyl-benzoate solutions are of no practical interest since the solvent appears to inhibit the bactericidal action of much more potent substances, and is relatively toxic to higher animals.

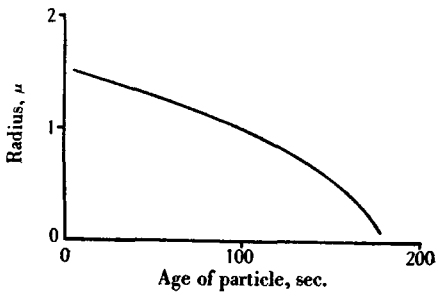
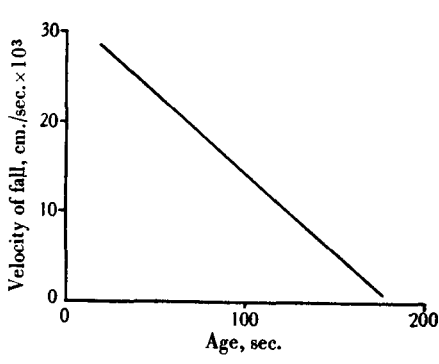

Fig. 5. Evaporation rate of benzylbenzoate.

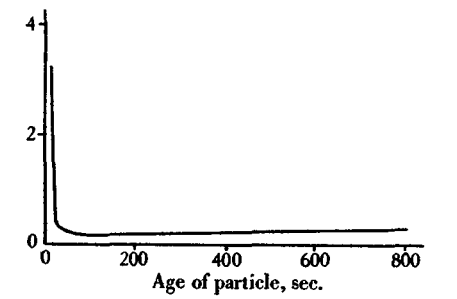
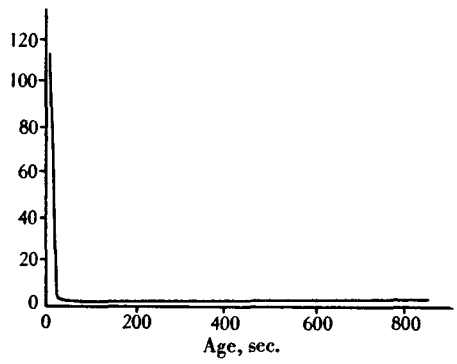

Fig. 6. Evaporation rate of ethylene-glycol.

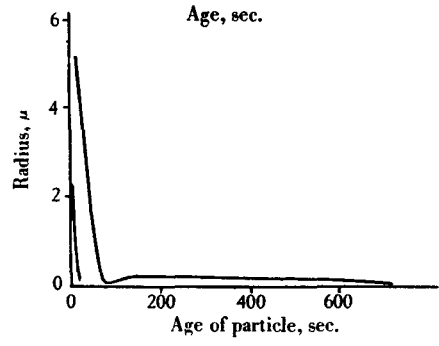
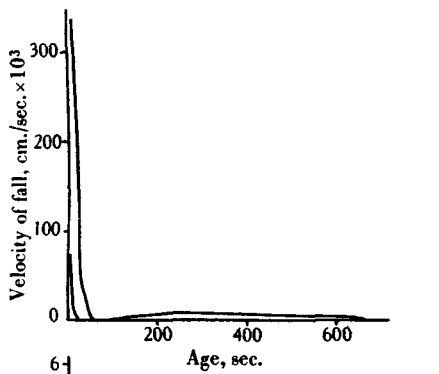

Fig. 7. Evaporation rate of propylene-glycol (saturated atmosphere).

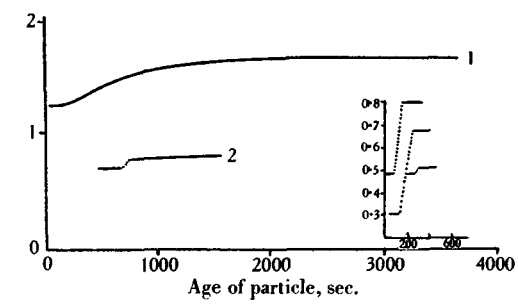
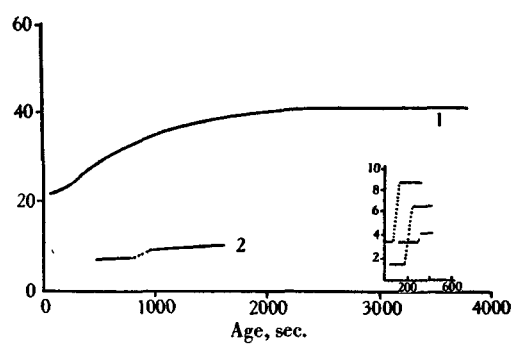

Fig. 8. Evaporation rate of 10 % W/W hexylresorcinol in propylene-glycol (saturated atmosphere).

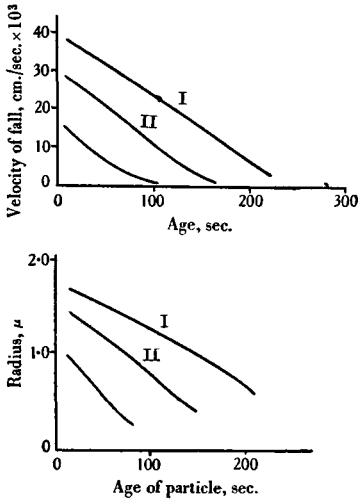

Fig. 9. Evaporation rate of 10% W/W amyl-meta-cresol in benzyl-benzoate.

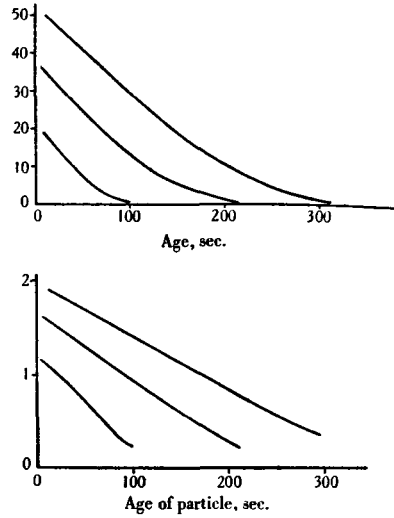

Fig. 10. Evaporation rate of 10% W/W benzyl-cresol in benzyl-benzoate.

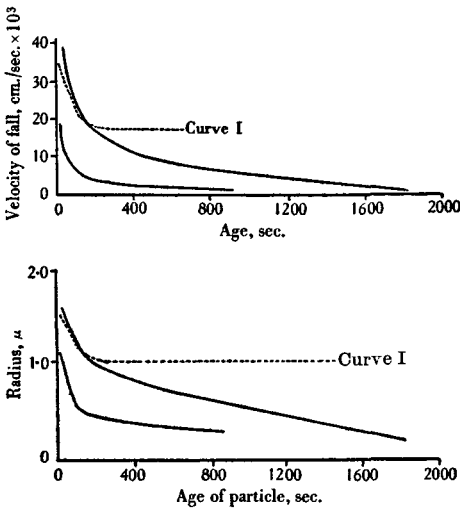

Fig. 11. Evaporation rate of 10% W/W hexyl-resorcinol in benzyl-benzoate.

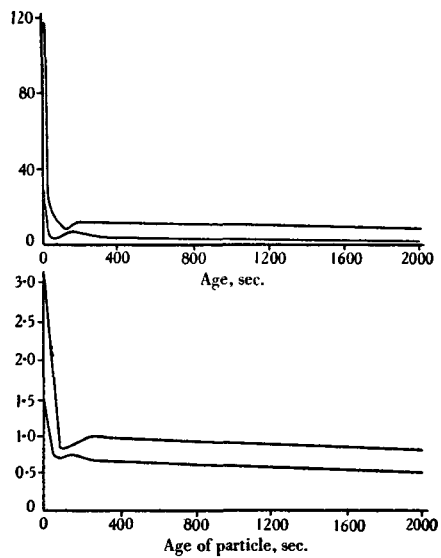

Fig. 12. Evaporation rate of 10% W/W amyl-meta-cresol in propylene-glycol.

Solutions of phenols in glycols

In agreement with what has been stated regarding the polyhydroxy compounds themselves, the behaviour of their solutions was complex. The same three germicides as for benzyl-benzoate (p. 262) were chosen as representative, in 10% W/W solution in propylene-glycol.

The behaviour of the amyl-cresol solution was similar to that of the pure solvent, and observations of the initial rapid evaporation (this will subsequently be called the "first phase") which was, if possible, even faster than with glycol itself, could only be made in an atmosphere already partially saturated with respect to the latter (Fig. 12). The same minimum then appears, and the secondary particles are persistent. Naturally the very high rate of evaporation in free air makes this solution useless for purposes of air disinfection, in spite of the high Rideal-Walker value of amyl-cresol (cf. Table 3).

The solution of benzyl-cresol in propylene-glycol is of some interest in being a fairly powerful germicide when dispersed in air. Accordingly it is found that its particles have quite a different life history from those of amyl-cresol (Fig. 13). The first phase appears quite definitely; there is then a transition period, followed by the second phase, when the slopes (dv/dt) of the velocity of fall-time curves are nearly constant, and during which the bactericidal action is probably exerted. The largest particles persist for some time after the second phase is over, but, as in any mist which would be used in practice, few such particles would be present, they would make but little contribution to the total activity of the mist. Actually, bacteriological experiments show that the effectiveness of such a mist is practically confined to the first 5 min. of its life, in agreement with the present measurements.

The hexyl-resorcinol solution (Fig. 14) shows still further deviation from the behaviour of the pure glycol. Here the first phase must be extraordinarily short (it cannot be shown on the scale of Fig. 14). Only by blowing the mist from the atomizer directly into the ultramicroscope cell can particles be caught while the initial evaporation is still taking place (and it is not often possible to read a velocity within 5 sec. of a particle's injection). After the first phase a steady evaporation proceeds which is even slower than when benzyl-benzoate is the solvent (Fig. 11).

Of all the germicidal mists examined biologically, that of a propylene-glycol solution of hexyl-resorcinol is the most potent, and this must be due in large part to the very slow evaporation of its droplets.

It was difficult to obtain consistent results for the evaporation rate of mists of hexyl-resorcinol in propylene-glycol, owing to its low vapour pressure and consequent ease of saturation of the medium. Thus in Fig. 14, showing two sets of three curves each, chosen from a large number of experimental figures, those curves (I, IV and VI) having the higher gradient will be more nearly correct than their neighbours (II, III and V).

On account of their practical importance (Shepherd, Finn, Powell & Shepherd's Industries Ltd., 1939) solutions of hexyl-resorcinol in propylene-

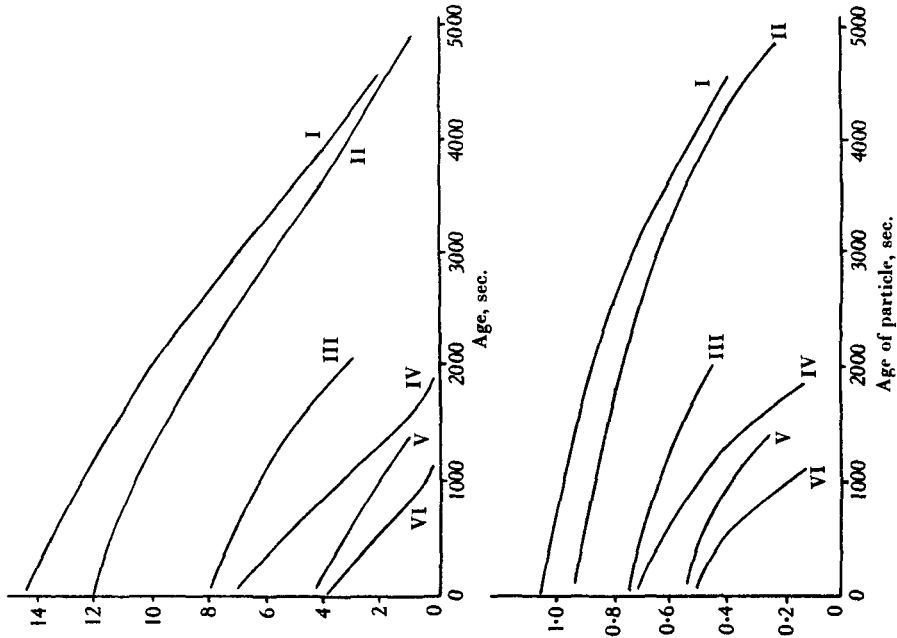

Fig. 14. Evaporation rate of 10% W/W hexyl-resorcinol in propylene-glycol (unsaturated).

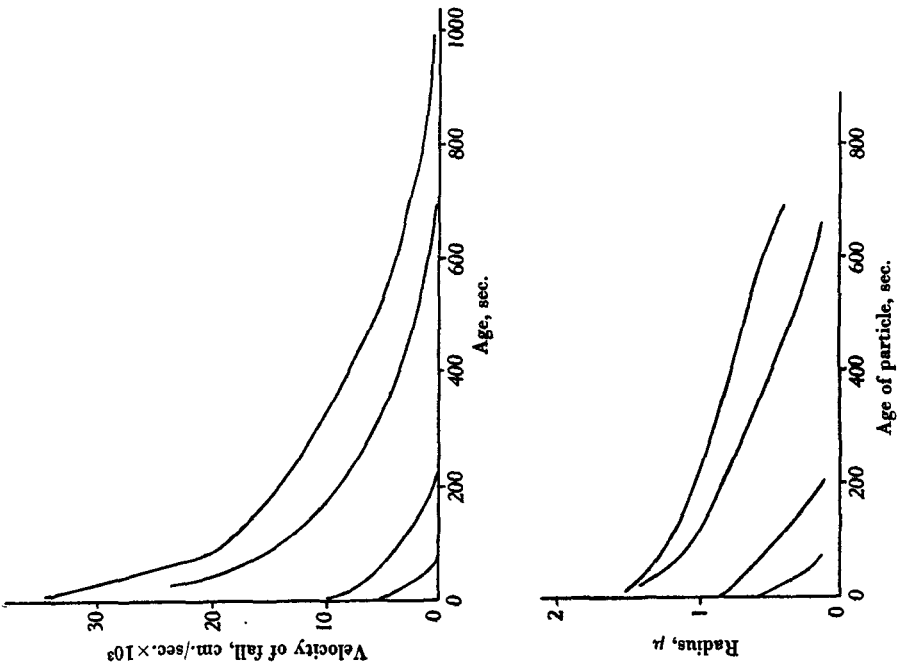

Fig. 13. Evaporation rate of 10% W/W benzyl-cresol in propylene-glycol.

glycol were investigated further. Figs. 15–20 inclusive are the evaporation curves of solutions in propylene-glycol of 1, 5, 15, 20, 25 and 50% W/W hexyl-resorcinol respectively. The same difficulty of saturation was found, so that some of the particles represented in the figures evaporate more slowly than they should do. With the 1, 5 and 10% (Fig. 14) solutions, in favourable conditions; the first phase of evaporation could be observed; the rest did not show it, owing either to its absence or to its very short duration. In every case particles of these

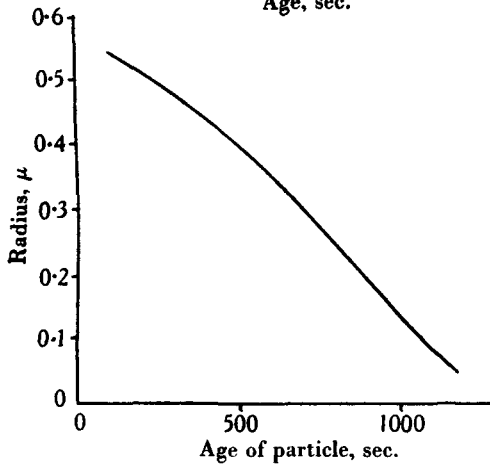
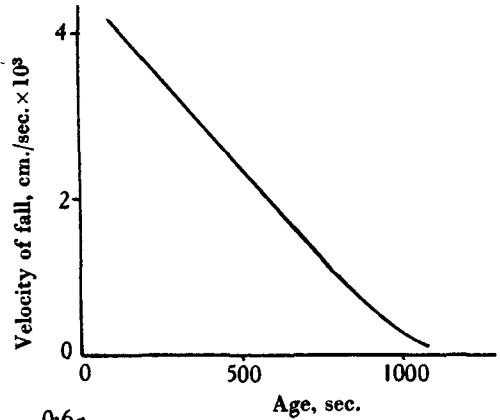

Fig. 15. Evaporation rate of 1% W/W hexyl-resorcinol in propylene-glycol.

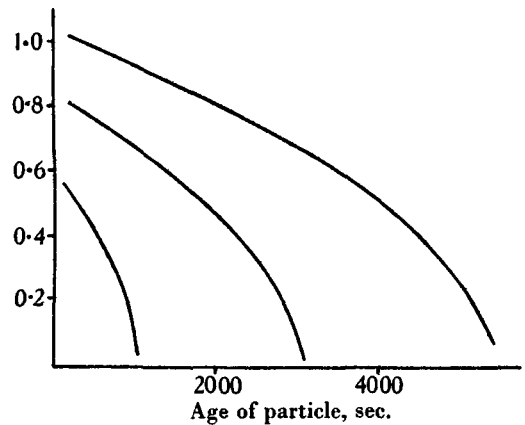

Fig. 16. Evaporation rate of 5% W/W hexyl-resorcinol in propylene-glycol.

solutions followed closely the straight-line law in their second phase, the 5 and 10% solutions showing no noticeable tailing off. Fig. 21 is a composite graph, obtained by freehand intrapolation from those of Figs. 14–20, to exhibit the relative rates of evaporation of 1μ droplets 100 sec. old, of the various solutions. There is a discrepancy, probably due to experimental inaccuracy, in that the 25% curve does not fall, as would be expected, between the 20 and 50% curves—but clearly the 5 and 10% solutions show a much greater persistence than the rest.

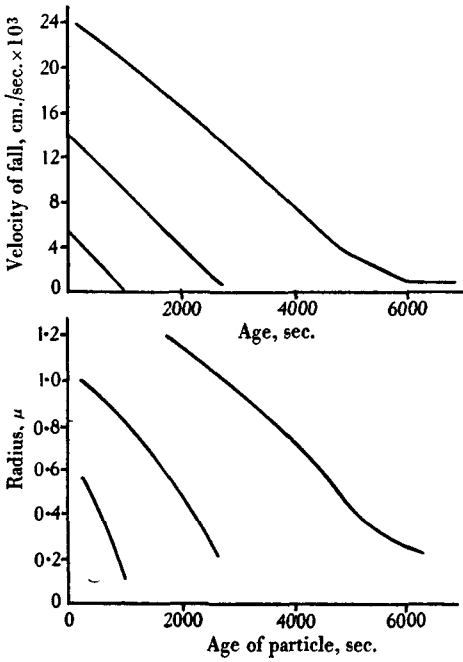

Fig. 17. Evaporation rate of 15% W/W hexyl-resorcinol in propylene-glycol.

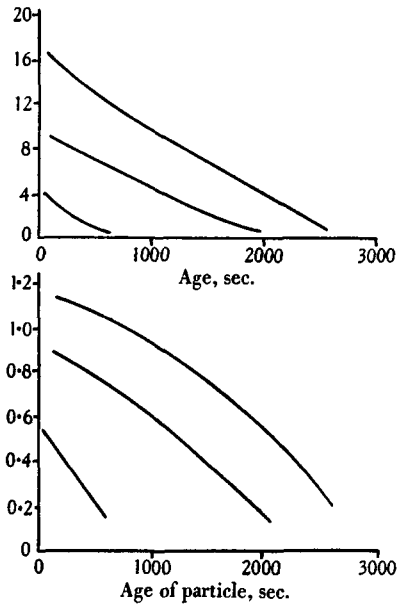

Fig. 18. Evaporation rate of 20% W/W hexyl-resorcinol in propylene-glycol.

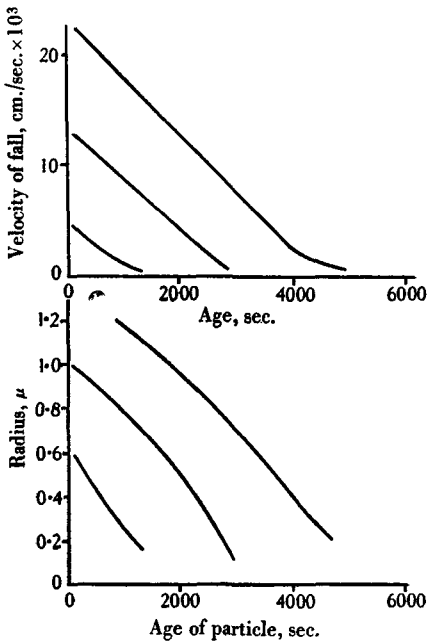

Fig. 19. Evaporation rate of 25% W/W hexyl-resorcinol in propylene-glycol.

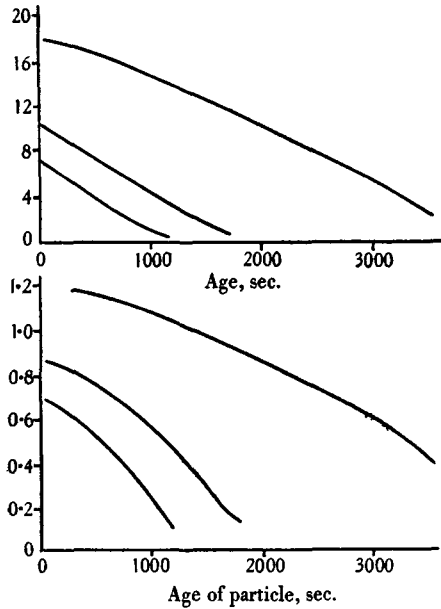

Fig. 20. Evaporation rate of 50% W/W hexyl-resorcinol in propylene-glycol.

Biological experiments (Table 13) show that the bactericidal activity of hexyl-resorcinol in propylene-glycol also reaches a maximum at about 10%. If association between solvent and solute is the reason for the enhanced persistence at this strength it might be possible to detect it by plotting the refractive indices against the composition. When this was done a straight-line relation was obtained, within the limits of the experimental error, the values obtained at 25° C. ranging from 1.4308 for propylene-glycol to 1.4811 for a 50% solution. We have no evidence at present to indicate that association does occur between solvent and solute, but we intend to carry out density and viscosity determinations later, and these may possibly throw light on the matter.

If the plausible assumption is made, that an initial phase of greater or less duration occurs with all these solutions, it can be understood why this

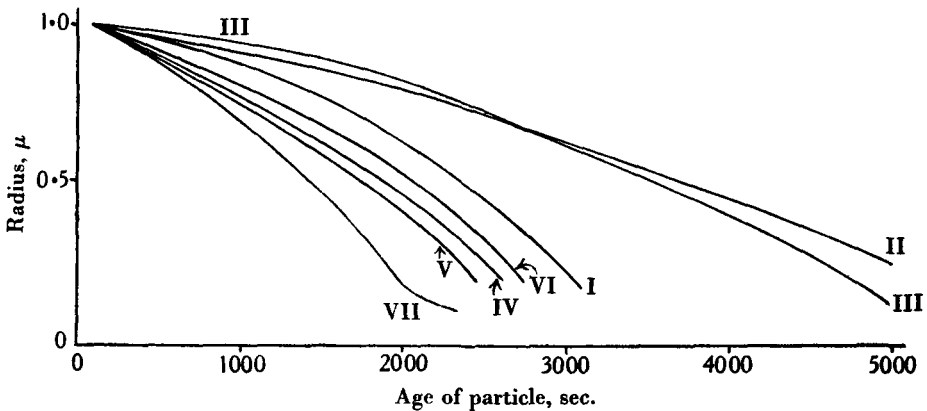
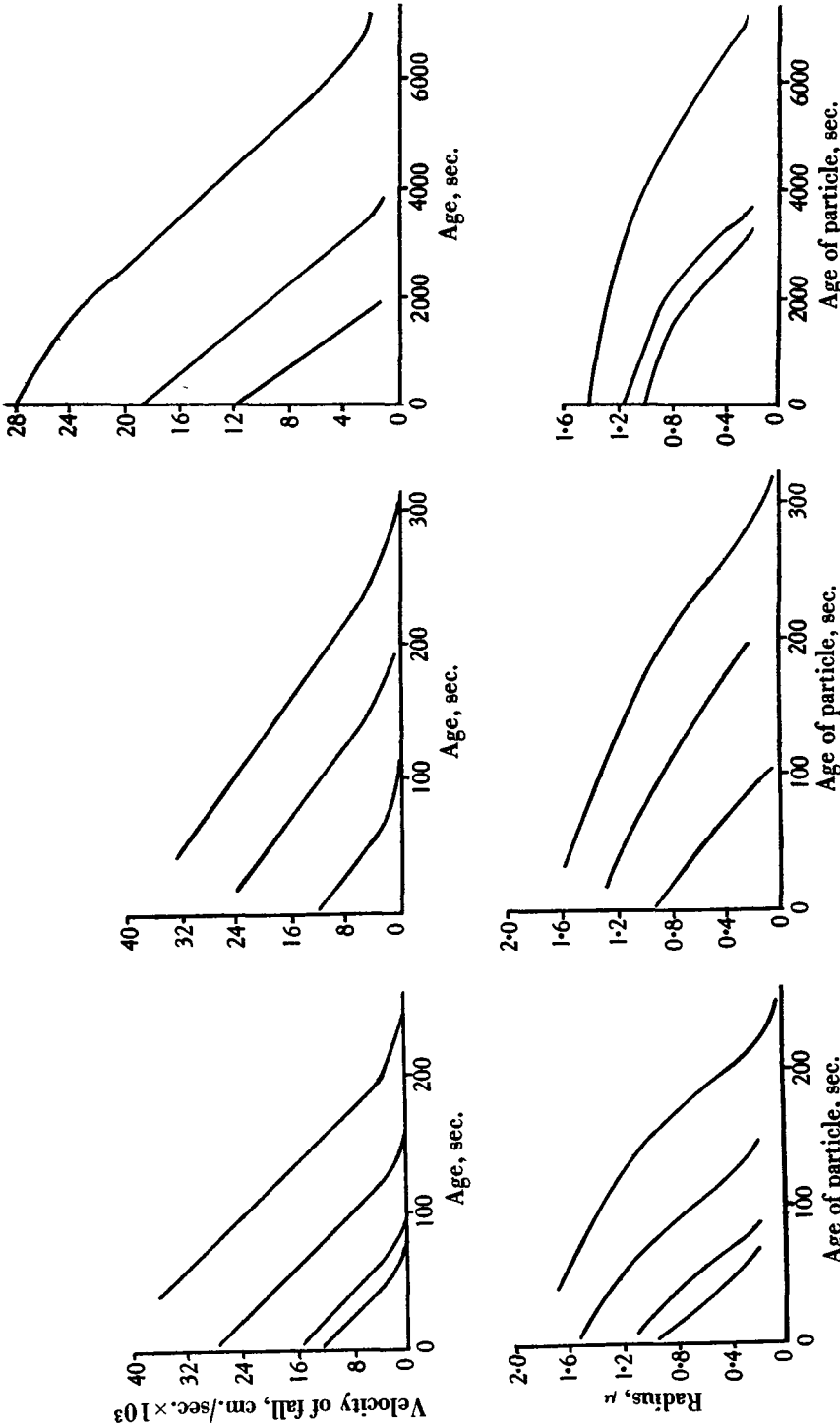

Fig. 21. Comparison of evaporation rates of various strengths of hexyl-resorcinol in propylene-glycol. I = 1%, II = 5%, III = 10%, IV = 15%, V = 20%, VI = 25%, VII = 50%. (Composite graph of Figs. 14–20.)

maximum in the persistence occurs. Droplets of the weak solutions evaporate extremely rapidly down to a small size before the solute concentration becomes large enough to affect the rate appreciably and the evaporation proceeds the further because for a given concentration, the “evaporation tension” ($-dr/dt$) is greater the smaller the radius of the particle. The particles thus reach a composition comparable with that at which those of the stronger solutions begin and so behave in apparently the same way when they come under observation. But with intermediate initial compositions, first phase evaporation does not go very far before the concentration is raised considerably and probably above that of the stronger solutions; the particles are still large compared with their original size and the evaporation tension is but little increased. Therefore we have the effect exhibited in Fig. 21 for particles having the same radius after first phase evaporation is over. The varying extent to which the latter proceeds is confirmed by an observed increase in the proportion of large droplets in the mists as the scale of initial concentration



Figs. 22-24. Showing evaporation rate of 10% W/W resorcinol in propylene-glycol and ethylene-glycol and of 10% hexyl-resorcinol in ethylene-glycol.

is ascended. This variation in the effective size distribution in the mists is dealt with more fully later (p. 279).

The behaviour of 10% hexyl-resorcinol in propylene-glycol has been compared with that of 10% resorcinol in propylene-glycol (Fig. 22), 10% resorcinol in ethylene-glycol (Fig. 23) and 10% hexyl-resorcinol in ethylene-glycol (Fig. 24). The results show that although ethylene-glycol is less volatile than propylene-glycol, its solution with hexyl-resorcinol is less persistent as a mist than is that with propylene-glycol. Resorcinol does not show this anomalous behaviour, the persistence of mists formed by its glycol solutions being in the inverse order of the volatilities of the glycols.

Watery solutions

The commercial product "Aéryl", which we find to consist approximately of water (48), glycerol (7) and resorcinol (45% by weight), together with a dye equivalent in colour to 0.01% of brilliant green, has been the most effective aerial germicide mentioned in the literature so far (Trillat, 1938*a, b*; 1939; Pulvertaft, Lemon & Walker, 1939). The investigation of the evaporation of "Aéryl" droplets is therefore of special interest (Fig. 4). In addition to "Aéryl" itself, other solutions of associated interest have also been examined, namely:

5% W/W glycerol in water (Fig. 25).

10% W/V resorcinol in water (Fig. 26).

25% W/V resorcinol in water (Fig. 27).

10% W/W resorcinol in 5% W/W glycerol in water (Fig. 28).

10% W/V resorcinol in 20% V/V glycerol in water (Fig. 29).

It is noteworthy that the resorcinol-water mixtures evaporate for the greater part of their lives according to the straight-line law, and remarkably enough, not only do particles of all apparent initial sizes yield evaporation curves of equal slope, but the value of the latter is the same for both the 10 and 25% solutions ($dv/dt = -1.67 \times 10^{-4}$ cm./sec./sec.), within the limits of error.

It would appear, then, that over a certain range of concentration and droplet size, the evaporation takes place without change of composition, or that if the composition does change, the evaporation rate is independent of this variable.

This unacceptable conclusion is avoidable if it be assumed that a first phase evaporation takes place too rapidly to be seen under the microscope. That this is possible is shown by Whytlaw-Gray & Patterson's (1932, p. 176) estimate of the time of evaporation of a 10μ radius water drop, namely 0.06 sec. The great disparity between the volatilities of the two constituents will result in the production of practically pure resorcinol, and accordingly, the result to be expected for a pure substance is found. Alternatively, and with the same effect, the first phase evaporation may lead to a mixture of water and resorcinol of the same composition in all cases. The present experiments do not enable us to decide.

The second phase (straight-line) evaporation rate is controlled by the

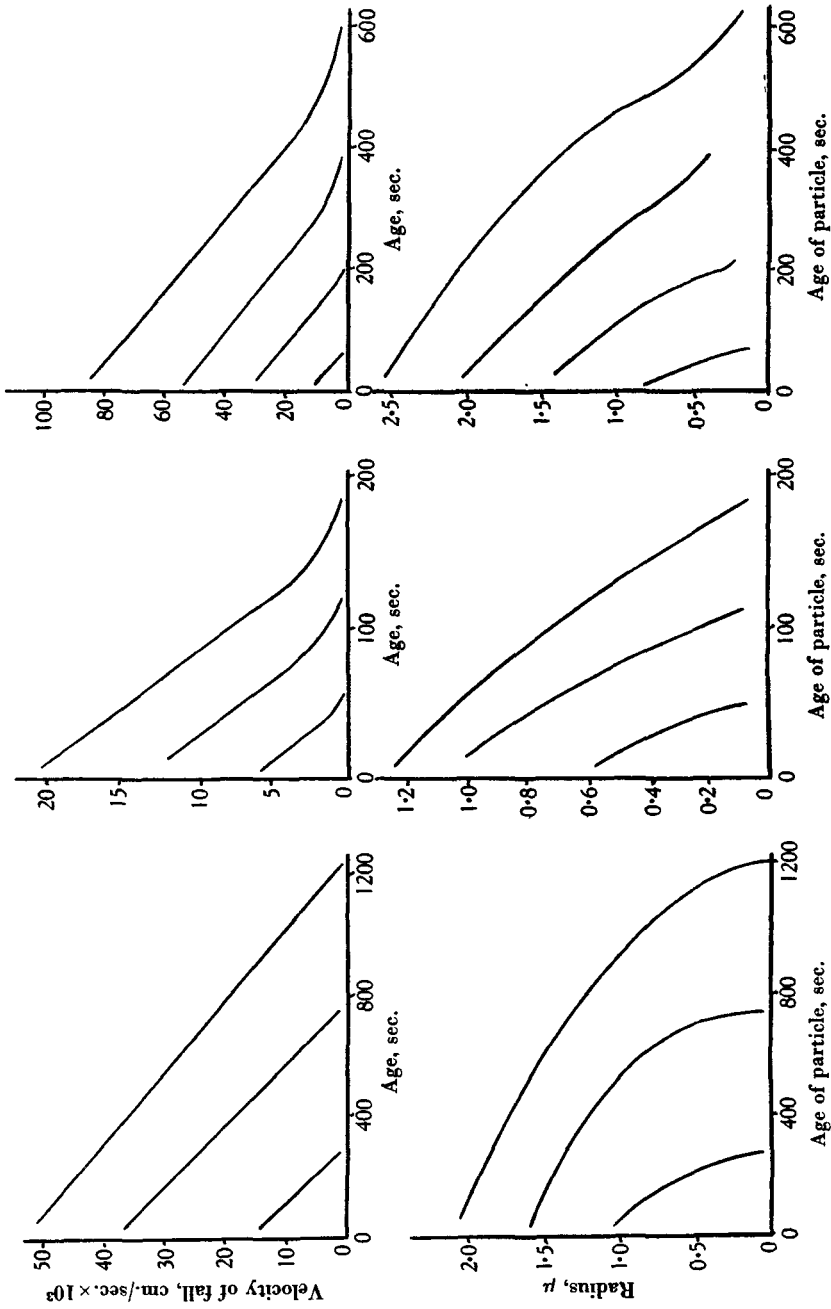

Fig. 25
Fig. 26
Fig. 27
Fig. 28
Figs. 25-27. Showing evaporation rate of 5% glycerol, 10% resorcinol and of 25% resorcinol in water.

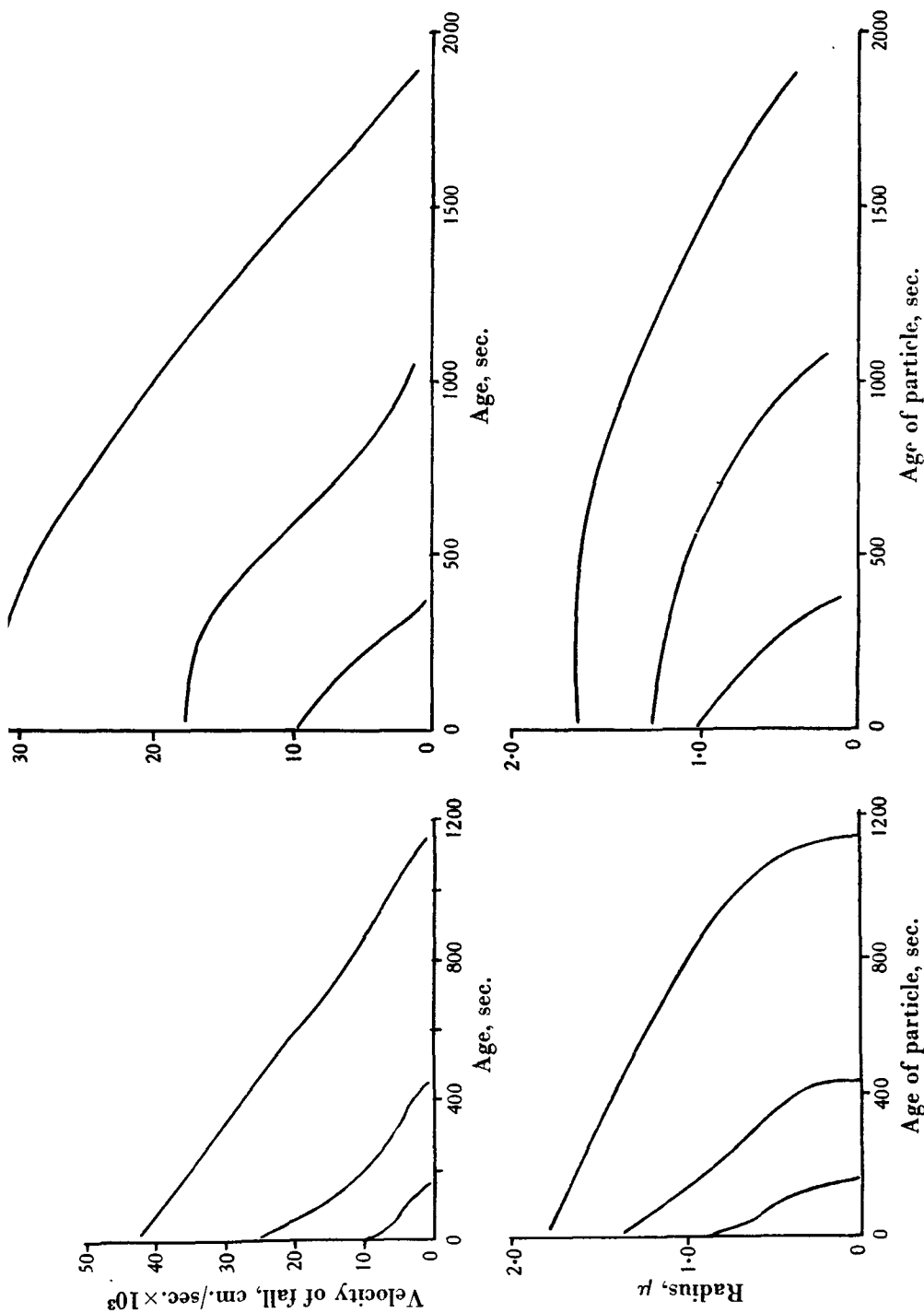

Fig. 28, 29. Showing evaporation rate of 10% resorcinol in 5% glycerol in water and in 20% glycerol in water.
Fig. 29

glycerol when this substance is present in addition. The glycerol-water solution (Fig. 25) behaves very differently from pure glycerol. Here with the larger droplets evaporation proceeds at a constant rate to completion—there is no “third phase” whatever. A 2μ droplet of this 5% solution, if it lost all its water, would leave a residue—about 0.75μ in radius—much too large to be missed, and glycerol droplets of this size, even if they have already absorbed water when measured, do not evaporate at anything like the rate found here (cf. p. 261). It is therefore absolutely necessary to suppose that a solution is formed in the first phase which possesses a certain limited stability of composition, especially as droplets of all sizes from 1μ upwards, but not below, evaporate at the same speed. The replacement of 10% of the water by resorcinol (Fig. 28) does not alter the second phase evaporation rate of the larger droplets (*ca.* -4×10^{-5} cm./sec./sec.) appreciably; even with “Aéryl” (nearly 50% resorcinol), the rate is only a little less than this, and the difference is accounted for by the increased glycerol concentration (7%).

With 10% resorcinol the third phase shows a peculiar inflexion, but still there is no great decrease in slope. The first phase for “Aéryl” is of comparatively long duration and obviously some of the resorcinol evaporates in this stage. Further, comparison of Figs. 25, 28 and 4 shows that the smaller particles at first evaporate the more rapidly the more resorcinol they contained initially. It follows that since for their radius-age curves d^2r/dt^2 is always positive, it must be chiefly resorcinol which then evaporates from them, though later and in the third phase, d^2r/dt^2 is negative.

When 20% of glycerol is present (Fig. 29), the curves obtained do not fall into line with those previously described, and are of quite a new type. Obviously, before a complete description of the behaviour of glycerol-water-resorcinol mixtures can be attempted, a much wider range of solutions must be examined. However, it can be seen at once that the constant-evaporating mixture of glycerol and water suggested above can only be characteristic of the 5% solution, for here the straight part of the velocity of fall-age curves has a slope (-2×10^{-5} cm./sec./sec.) only half that previously found, the difference being obviously conditioned by the increased concentration of glycerol.

It was suggested by Pulvertaft in a private communication that the glycerol which is responsible for the persistence of “Aéryl” droplets might profitably be replaced by a much smaller quantity of a polyhydroxy alcohol, of high molecular weight, which by virtue of its involatility and possibly of its greater power of solvation, would do the same work. He submitted three solutions for examination, which were stated to be:

- 10% W/V resorcinol plus 20% V/V glycerol (vide supra and Fig. 29).
- 10% W/V resorcinol plus 1% W/V sorbitol (anhydrous) (Fig. 30).
- 10% W/V resorcinol plus 0.1% W/V sorbitol (Fig. 31) in water.

The evaporation curves for sorbitol-containing droplets are exactly similar to those for a 10% aqueous solution of resorcinol alone, in their second phase.

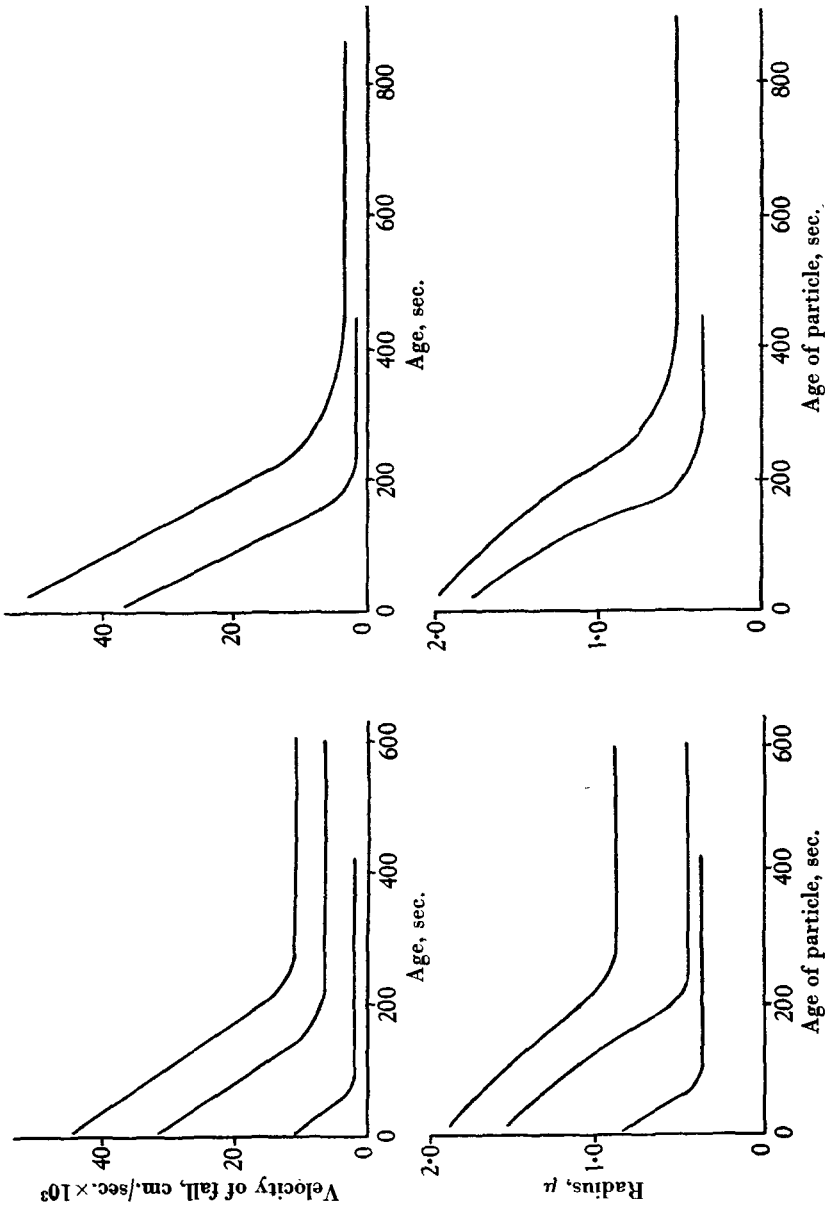

Fig. 30

Fig. 31

Figs. 30, 31. Steady evaporation rate of 10% resorcinol in water and 0.1% sorbitol in water.

The slope is the same ($dv/dt = -1.67 \times 10^{-4}$ cm./sec./sec.). There is a third phase in which the slope decreases, due to the increased sorbitol concentration, and finally reaches zero, with the formation of a stable residue. This result is perhaps to be expected; sorbitol itself does not evaporate, and weight for weight is less effective than glycerol in reducing the vapour pressure of a solvent, since its molecular weight is higher and its small concentration in these solutions can therefore have little effect on their first and second phase evaporations. If it is assumed that from these droplets all the water is lost by evaporation except enough to form the hemihydrate of sorbitol, and by extrapolating the straight part of the velocity-age curves to zero time (i.e. neglecting the concentration by first phase evaporation), in order to obtain values for the initial radii, it is possible to calculate the minimum concentrations of sorbitol and maximum concentrations of resorcinol in the droplet residues as shown in Table 5.

Table 5

Initial sorbitol concentration %	Initial radius of particle r_1 (μ)	Radius of residue r_2 (μ)				[Sorbitol hydrate] in residue %
			r_1^3	r_2^3	r_1^3/r_2^3	
1	1.95	0.89	7.41	0.715	10.3	10.8
	1.60	0.71	4.09	0.358	10.7	11.2
	1.19	0.56	1.68	0.176	9.6	10.1
	0.92	0.39	0.779	0.0592	13.1	13.8
	0.71	0.24	0.358	0.0138	25.8	28.4
0.1	2.12	0.50	9.52	0.125	76.1	8.0
	1.78	0.37	5.63	0.0507	111	11.6
	1.40	0.24	2.74	0.0138	198	20.8
	1.10	0.17	1.33	0.0049	271	28.4
	0.85	0.12	0.51	0.0017	559	36.0

The degree of concentration of the sorbitol is considerable, of the orders of at least ten and one hundred times for the 1 and 0.1% solutions respectively. Since the evaporation tension ($-dr/dt$) is relatively higher for smaller droplets, evaporation must proceed relatively further before the sorbitol can take charge in slowing it up; hence the sorbitol concentration is greater the smaller the radius of the residual drop. The tenfold increase in sorbitol concentration of the 1% solution droplets will just permit the retention of all the original resorcinol in the residue, but since the second phase evaporation follows the same course as that of simple resorcinol-water mixtures, and since the curves for the latter show that much of the resorcinol must evaporate during this stage, there must be less resorcinol in the residue than was present originally, and some water must have been retained—all this without taking into account a probably considerable first phase evaporation. Quite apart from this, the hundredfold increase in sorbitol concentration for the 0.1% solution implies the loss of not less than 90% of the resorcinol. Clearly, sorbitol cannot satisfactorily replace a larger proportion of glycerol. The presence in the medium of large amounts of wasted resorcinol militates against the use of aerosols of this type.

Baker has shown (p. 308) that the presence of saliva has a marked damping effect on the germicidal action of hexyl-resorcinol in propylene-glycol, but that this effect is very much less noticeable with "Aéryl". In the hope of gaining some idea of the mechanism by which "Aéryl" acts in the presence of saliva, and also of the behaviour of a composite droplet formed by the collision of "Aéryl" droplet with one in which saliva is present, the following solutions were examined:

- 50% W/W "Aéryl" in water.
- 25% W/W saliva in water.
- 50% W/W Reddish broth in water.
- 50% W/W "Aéryl" in 50% saliva in water.
- 50% W/W "Aéryl" in Reddish broth.

The rate of evaporation of droplets of these substances is shown in Figs. 32-36. Little can be deduced from the results to throw any light upon the mechanism of the action. As would be anticipated, both saliva and Reddish broth solutions in water show an initial rapid evaporation and leave non-volatile residues; in the flat portion of these curves sudden increases in size of the droplet were observed, probably due to collision with submicroscopic particles as already mentioned. The presence of saliva or broth makes little difference to the rate of evaporation of the "Aéryl", as indicated by the initial rate of evaporation of the composite droplet; it appears, however, that the residues left by saliva or broth in the presence of "Aéryl" are smaller than in its absence. The explanation is that initial rate of loss of water from saliva and broth solutions is too fast to be observed, and that the original size of the drops leaving the residues shown in the figures were much greater than indicated. The presence of "Aéryl" retards the initial loss of water, and the droplets can be observed before very much evaporation has taken place.

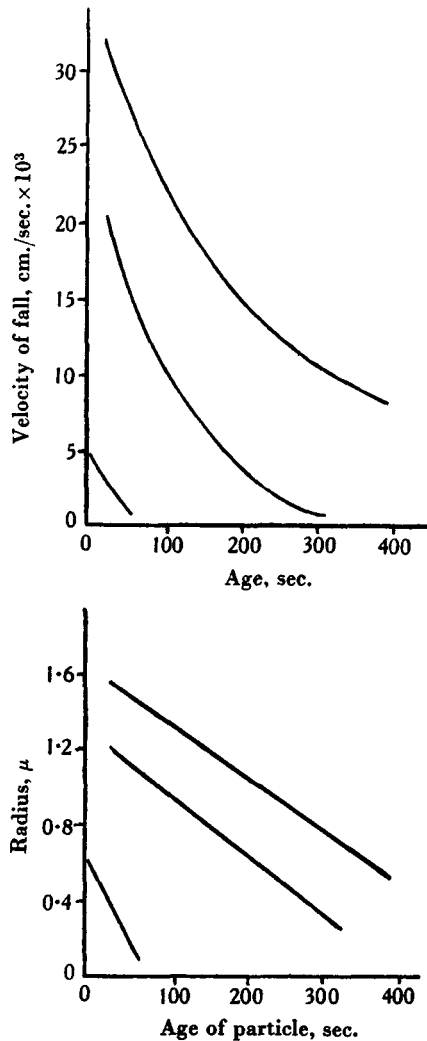

Fig. 32. Showing evaporation rate of 50% "Aéryl" in water.



Fig. 33

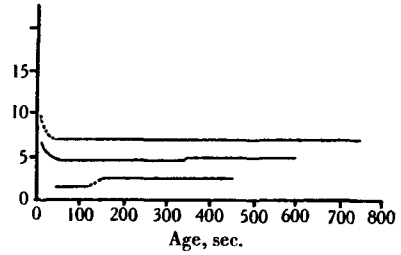
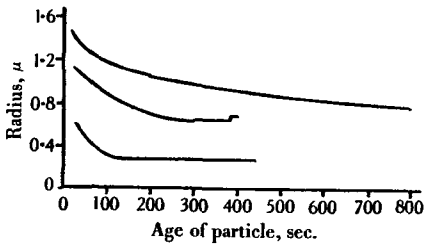

Fig. 34

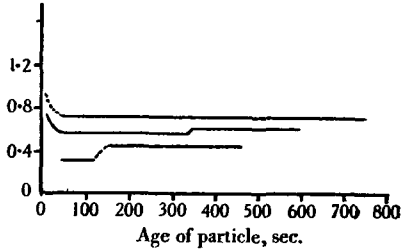

Fig. 35

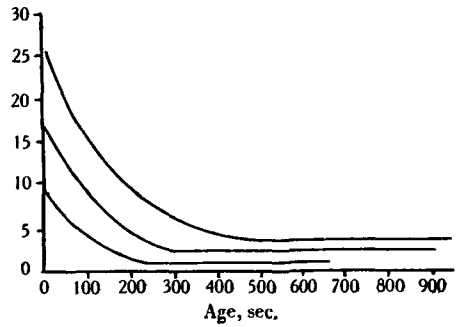
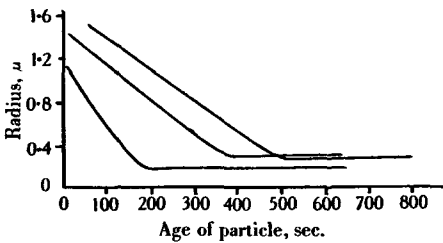
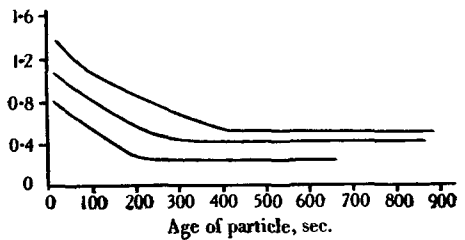

Fig. 36



Figs. 33-36. Showing evaporation rate of 25% saliva in water, of 50% broth in water, of 50% "Aéryl" in 50% saliva in water and of 50% "Aéryl" in broth.

The effective size distribution in mists of hexyl-resorcinol—propylene-glycol solutions

The size distribution in a mist is usually far more characteristic of the means by which it was produced than of the substance of its particles. At the same time, the methods available for determining frequency curves, besides being of doubtful accuracy at low radii, are slow and therefore cannot give results of much significance when the particles in the mist are evaporating at an appreciable rate. With the hexyl-resorcinol—propylene-glycol mists (p. 269), however, it was felt that rough measurements of the size distribution would yield useful confirmation of the presence and extent of first phase evaporation. That is to say, that since the second phase rate is very small, and the first phase is over in a few seconds, differences in the extent of the latter would be expressed as differences in the fineness of the mist *when measured*, provided of course, that the same atomizer was used throughout.

The following technique was adopted:

The ultramicroscope was set up with the micrometer eyepiece as described previously. A fairly concentrated sample of mist was drawn into the cell and particles, chosen as far as possible at random, were timed in their transits between the cross-wires set at a known distance apart. The timing was carried on as quickly as possible until the denseness of the mist diminished noticeably, and all the transits were listed under the size of objective in use. Since any particular objective tends to give preference in timing to a limited range of fall-velocities, five were employed, of 2 to $\frac{1}{4}$ in. focal length, and the same number of samples (usually 6, 8 or 12, according to the persistence of the mist), were examined with each. Thus five columns of transit times were obtained, generally 500–1000 in all. A table was prepared giving the range of transit times corresponding to a number of arbitrarily chosen ranges of radius for each objective. (The differences in density of the solutions under consideration were not great enough to make necessary a table for each solution.) The number of particles in each size range and for each objective was counted and entered in another table. This number was divided by the total number observed with that objective, giving the proportion of particles in the range. The five proportions corresponding to the

Table 6

Radius of particle <i>r</i> (in μ)	Velocity of fall cm./sec. $\times 10^{-4}$	Transit times for 200 divisions of micrometer (sec.)					
		Objective ...	N. and Z. 2 in.	Steward 1 $\frac{1}{2}$ in.	Beck $\frac{2}{3}$ in.	Hensoldt no. 10	Beck $\frac{1}{4}$ in.
		Real equivalent fall distance (cm.) ...	6.05×10^{-2}	4.01×10^{-2}	1.912×10^{-2}	1.58×10^{-2}	0.942×10^{-2}
0.05	0.916	—	—	—	172	103	
0.1	2.295	—	—	83.4	68.8	41.1	
0.2	7.01	—	57.3	27.3	22.5	13.4	
0.4	11.52	52.5	34.8	16.6	13.7	8.166	
0.6	48.6	12.46	8.25	3.93	3.25	1.94	
0.8	85.3	7.09	4.70	2.24	1.85	1.10	
1.0	130.8	4.63	3.06	1.46	1.21	0.72	
1.3	217.0	2.79	1.85	0.88	0.73	0.43	
1.6	381	1.59	1.05	0.51	0.41	0.25	
2.0	497	1.22	0.81	0.38	0.32	0.19	
2.4	718	0.84	0.56	0.27	0.22	—	
2.8	1090	0.55	0.37	0.18	0.14	—	
3.2	1277	0.47	0.31	—	—	—	
4.0	1978	0.31	0.20	—	—	—	
6.0	4330	0.14	—	—	—	—	

five objectives used were added together, giving the total proportion in the range, and this figure divided by the width of the range. The final number so obtained was taken as the frequency at the mid-point of the range and was so plotted on a graph. Table 7 is given as an example.

Table 7

Distribution of particle size: 10% hexyl-resorcinol in propylene-glycol.
Atomizer: "Atmozon" no. 1. Air at 660 mm. above atmosphere.

Objective ...	N. and Z. 2 in.		Steward 1½ in.		Beck ¾ in.		Hensoldt no. 10		Beck ½ in.		Totals	
No. of observations, 6 fields per objective...	173		174		173		181		143		844	
Size range radii in μ	No.	Proportion	No.	Proportion	No.	Proportion	No.	Proportion	No.	Proportion	Proportion in range	Frequency
<0.05	—	—	—	—	—	—	—	—	2	0.014	0.014	0.028
0.05-0.1	—	—	—	—	—	—	—	—	9	0.063	0.063	0.126
0.1-0.2	4	0.023	8	0.046	19	0.110	12	0.066	34	0.238	0.483	0.483
0.2-0.4	9	0.052	4	0.023	12	0.069	16	0.088	20	0.140	0.372	0.186
0.4-0.6	88	0.509	84	0.483	102	0.590	108	0.605	59	0.413	2.600	1.300
0.6-0.8	36	0.208	36	0.207	15	0.086	28	0.155	15	0.105	0.761	0.380
0.8-1.0	17	0.099	27	0.155	16	0.093	9	0.050	3	0.021	0.417	0.139
1.0-1.3	13	0.075	13	0.075	4	0.023	5	0.028	1	0.007	0.207	0.069
1.3-1.6	5	0.029	2	0.012	2	0.012	—	—	—	—	0.052	0.017
1.6-2.0	1	0.058	2	0.012	3	0.017	2	0.011	—	—	0.045	0.011
2.0-2.4	—	—	—	—	—	—	—	—	—	—	—	—

Figs. 37-43 inclusive are the distribution curves for 1, 5, 10, 15, 20, 25 and 50% W/W solutions of hexyl-resorcinol in propylene-glycol determined by this method.

While obviously the results may be very inaccurate at extremes of radii, and the measurements are not sufficiently detailed, the observations show a clear increase in the average particle size of the mists with increase in concentration of solute, and constitute evidence for the existence of a variable first phase evaporation, such as was deduced above from a comparison of the particles' persistence.

Mist grading by means of centrifuge

It is obviously important to determine the optimum particle size in germicidal mists, the smaller the droplet the greater its mobility, and from this point of view it would seem that reduction in particle size would continue to give increased germicidal activity down to molecular size. We know, however, that vapours are ineffective, and some optimum particle size must occur between large drops which will quickly fall out of the air and particles approximating to molecular dimensions. The persistence of the droplet will also govern the most suitable particle size. A machine has been constructed (Finn, Powell & Shepherd's Industries, Ltd., 1939) somewhat on the lines of the Well's (1936) air centrifuge, by which particles above a predetermined size may be removed from the mist produced by a suitable atomizer. Fig. 44 shows diagrammatically the arrangement of the machine; the crude mist is led through a stationary, central tube into the annulus formed by two concentric cylinders, rotating at the same speed and in the same direction; during its

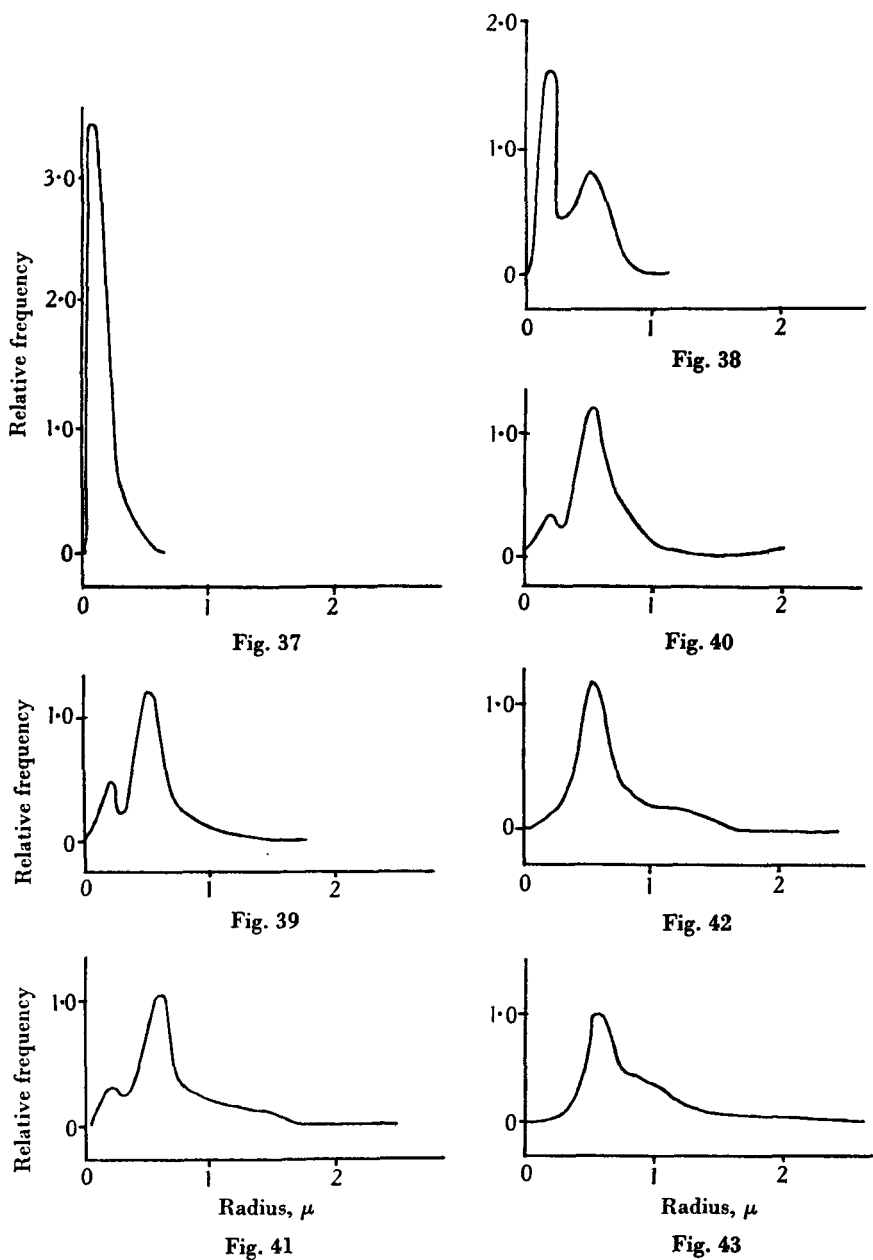

Figs. 37-43. Showing particle-size distribution curves of: (37) 1% hexyl-resorcinol in propylene-glycol, (38) 5% hexyl-resorcinol in propylene-glycol, (39) 10% hexyl-resorcinol in propylene-glycol, (40) 15% hexyl-resorcinol in propylene-glycol, (41) 20% hexyl-resorcinol in propylene-glycol, (42) 25% hexyl-resorcinol in propylene-glycol and (43) 50% hexyl-resorcinol in propylene-glycol.

passage along the annulus all particles above a given size are removed from the mist by collision with the outer rotating cylinder. The maximum size particle escaping from the centrifuge is governed by the rate of rotation and the air flow through the annulus. In the crude form of the apparatus shown in the diagram many particles below the desired maximum size are also removed from the mist; this is not a serious defect provided that the output of mist from the centrifuge is known.

An actual machine mounted against an experimental chamber (p. 297) is shown in Pl. VI. The rate of rotation is fixed at the desired value by means of a resistance, and the air flow through the machine determined by a Venturimeter or a Rotameter during a trial run prior to connecting the centrifuge with the experimental chamber. Fig. 45 connects the rate of rotation with the output of mist from the centrifuge, the latter being expressed as a percentage of the mist introduced into it from a definite atomizer at an air flow of 10 l./min. The output from the atomizer during an experiment is determined by weighing.

In general the machine has been used in conjunction with mists of 10% hexyl-resorcinol in propylene-glycol. Some loss of glycol may occur during the passage of the mist through the centrifuge; it is unlikely that any appreciable amount of hexyl-resorcinol will be lost during this period. In determining outputs from the centrifuge we have therefore made a practice of estimating the hexyl-resorcinol leaving the machine, and giving the mist concentration the nominal value of ten times this figure.

The relation between the rate of rotation of the centrifuge and the maximum size of particle escaping is shown in Fig. 46, curve 1, showing the behaviour of 10% hexyl-resorcinol in propylene-glycol, and curve 2 an involatile liquid paraffin. The largest particles observed when the centrifuge is stationary will naturally be limited by the size of particle produced by the atomizer; the discrepancy between the maximum size droplet at any given speed of the centrifuge when using paraffin, and hexyl-resorcinol in propylene-glycol respectively is due in part to their difference in density and partly to the evaporation of glycol from the latter during and after passage through the centrifuge.

Theoretically it would be expected that the radius of the maximum size particle leaving the centrifuge would be inversely proportional to the rate of rotation. In Fig. 47 the reciprocals of the radius are plotted against the speed of the centrifuge; with paraffin (curve 2) a straight-line relation is found as expected. Hexyl-resorcinol (curve 1) shows considerable curvature, especially at higher speeds, due to evaporation which increases with decreasing droplet size. The effect of centrifuging on the particle-size distribution in a mist is shown in Fig. 48. An involatile paraffin was used as working fluid.

Estimation of aerosols

The estimation of a germicidal aerosol depends first upon finding a method of concentrating the mist to a small volume, and secondly on a suitable chemical test. It might be possible to estimate an aerosol by measuring the light

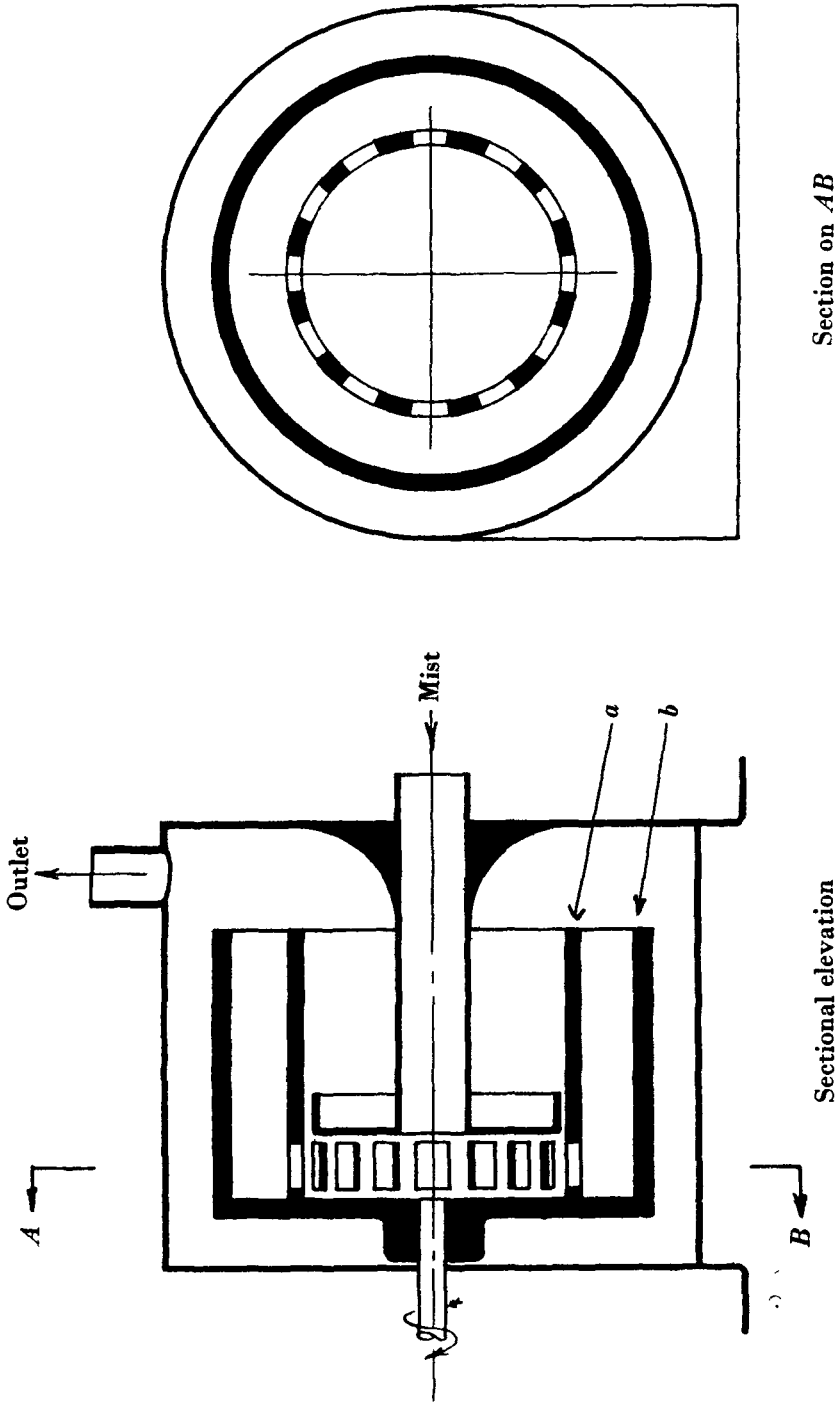

Section on AB

Sectional elevation

Fig. 44. Diagram of mist-grading centrifuge.

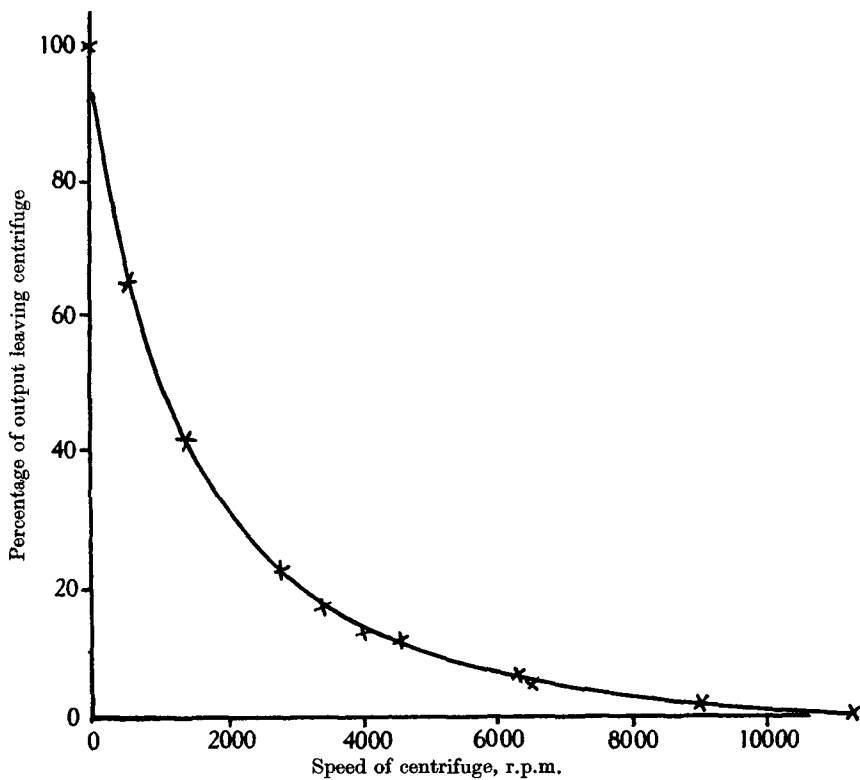

Fig. 45. Output/rotation curve for hexyl-resorcinol.

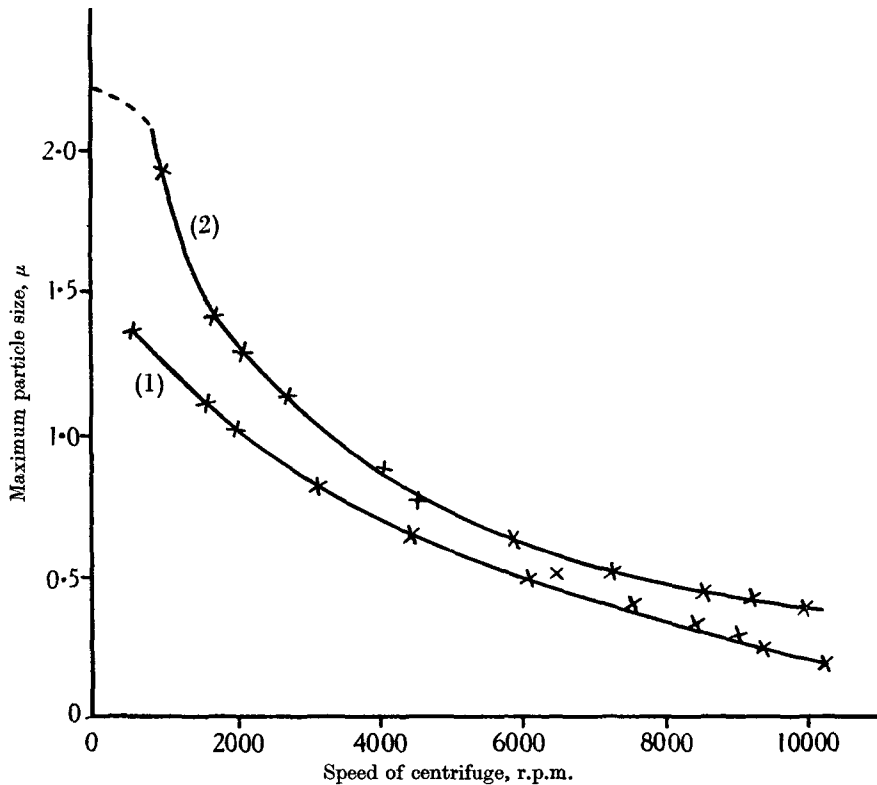

Fig. 46. Maximum size/rotation curves.

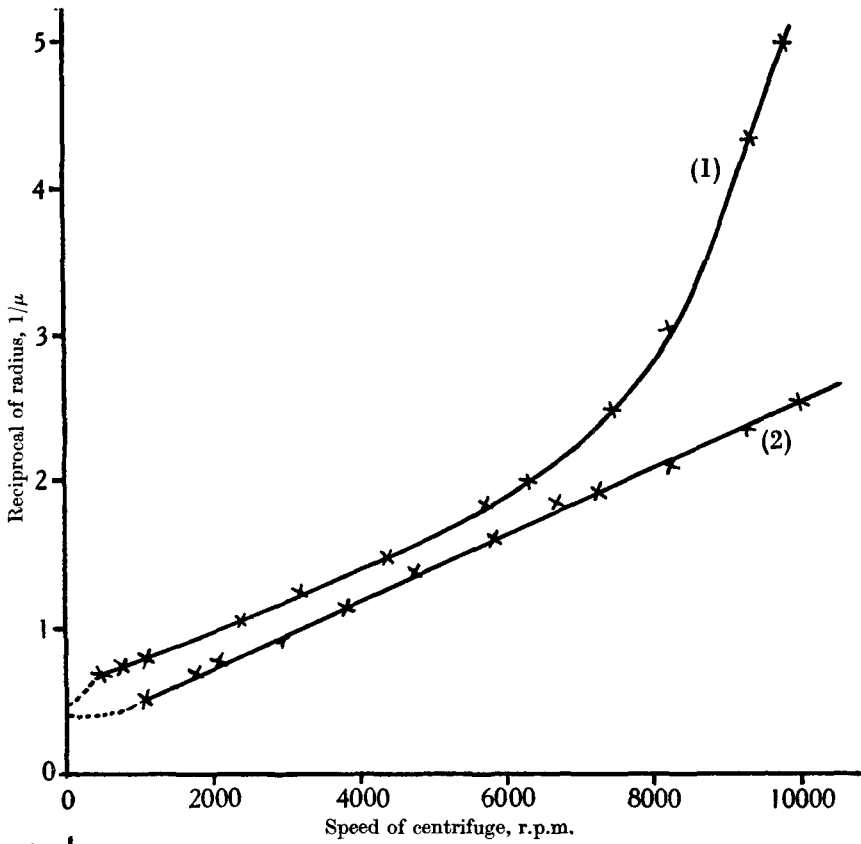

Fig. 47. Reciprocal maximum size/rotation curves.

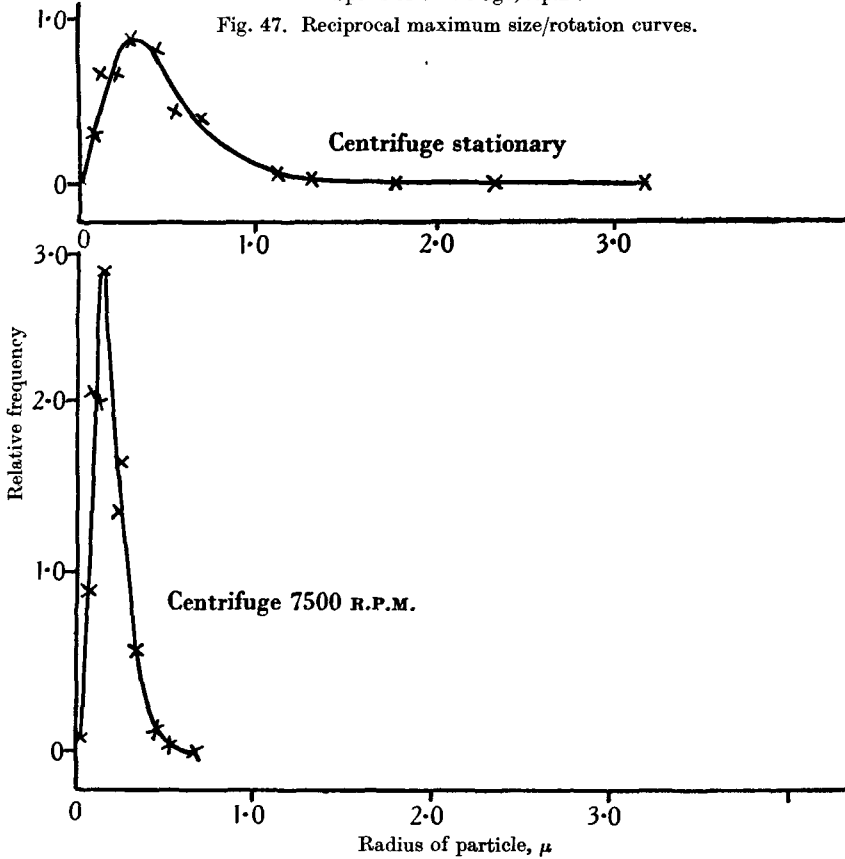

Fig. 48. Particle-size distribution after centrifuging.

scattered from it by means of a Tyndallmeter; this method has not yet been tried, in view of the changing size of the aerosol droplets, the presence of dust and a bacterial dispersion when considering our experimental chambers.

Chemical test

Practically all the germicides used during this work have been phenolic in character; they constitute the part of the aerosol in which we are chiefly interested, while they are much more easy to estimate than any of the solvents employed. The most delicate test for phenols in general is coupling with a diazotized amine or a stabilized diazo salt. Extensive tests have been made to determine the most sensitive reaction since our aim is to push the sensitivity to the limit, even at the expense of some precision. Benzyl-cresol, thymol and 4-*n*-hexyl-1:3-resorcinol were selected as phenols for comparison, and tested against a large number of diazotized amines and diazo salts. Simple amines like *p*-nitraniline give rather light colours, yellow to pink, which are indefinite in shade at high dilutions, and difficult to estimate. A number of amines of higher molecular weight and stabilized diazo salts of the "Brentamine" series¹ have been tested. The procedures used in preparing the reagents were as follows:

(1) "Brentamine" salts were made up in water, at a strength of 0.1%. These solutions will keep for a few hours only.

(2) Amines were made up in an amount of *N*/10 HCl 2½ times that required to form the salt, and diluted to 0.1% (0.05% for dibasic amines).

(3) If the amine did not form a hydrochloride (e.g. 2-amino-anthraquinone) it was dissolved in glacial acetic acid to 0.1%, and one drop of sulphuric acid per 10 c.c. was added.

1 c.c. of amine reagent was measured out and treated with one drop of 1% sodium nitrite in water, and allowed to stand for several minutes. The "Brentamine" salts do not require the addition of nitrite. For tests of the suitability of the amines 2.5 c.c. of the phenol solution (at a strength of 1 in 10⁵ and 1 in 10⁶), were taken and one drop of *N*/10 NaOH was added to each tube. One drop of a diazo solution or of a "Brentamine" solution was added, and then one further drop of caustic soda (*N*/10 for "Brentamine" and aqueous diazo solutions, 40% for acetic acid diazo solutions). In higher concentrations the full colour is not always developed by the addition of one drop of "Brentamine" solution, and an additional quantity may be added, drop by drop, until the maximum colour is reached.

With hexyl-resorcinol, *p*-nitraniline gives perhaps the most intense colour, but the shade given is rather inconsistent, and it is not always possible to match the sample with the controls. For most purposes, it is therefore preferable to use "Brentamine" Blue B.S. which gives consistent results and is almost as sensitive. The same remarks apply in a lesser degree to thymol and benzyl-cresol, "Brentamine" Red B.S. being the most satisfactory reagent in general.

The "indophenol" test (Houghton & Pelly, 1937; Folpmers, 1934) has been compared with the methods just described. A solution of *p*-nitroso-dimethylaniline is reduced with zinc dust and copper to 4-dimethylaminoaniline. A portion of this is filtered into the phenol solution to be tested, the whole being buffered with sodium bicarbonate. Weak hypochlorite solution is then run in to oxidize back just through the (red) Wurster salt stage to colourlessness. The indophenol colour develops on standing. If 50 c.c. of test solution

¹ Samples kindly supplied by Messrs I.C.I.

are available the sensitivity of this method is about equal to that of diazo coupling, but it is much less convenient. Generally the amount of test solution in these experiments is far too small to render the method of service.

Collection of sample of aerosol

The original method of estimating the weight concentration of an aerosol consisted simply in taking a sample of the air in an evacuated bottle, washing out the contents with a solvent, and estimating the phenol present colorimetrically; the method does not give complete sampling since many of the larger mist droplets may not be drawn into the sample bottle on account of their greater inertia, and further any of the germicide present in the air as vapour is included in the estimation. This is undesirable as we are generally only interested in the particulate concentration. The method is only applicable in high mist concentrations as the volume of the sampling vessel is limited to a few litres, and the extracts are not sufficiently concentrated for the colorimetric test unless a large amount of mist be present.

A centrifuge similar to that already described under mist grading, but running at 18,000 r.p.m., has been used to remove the particulate matter down to $<0.1 \mu$ from a stream of mist-laden air passing through it. The mist droplets so removed were collected on a paper liner placed in the outer rotating cylinder, and subsequently estimated by weighing. There are several objections to this method, they being principally:

- (1) Changes in weight due to the absorption or loss of water by the paper.
- (2) Evaporation of the relatively volatile solvent (usually glycols) from the condensed droplets. Experiments conducted by passing a known amount of mist through two centrifuges placed in series, the second running at a higher speed, showed that the evaporation increases with increasing speed of rotation, the apparent weight collected in the second centrifuge actually decreasing as its speed increases.
- (3) The weight of mist collected must be great compared to any changes occurring in the weight of the paper due to drying, etc. In order to collect droplets down to a reasonably small size the air flow through the centrifuge must not exceed 13 l./min., and as the concentrations of mist in air which we employ are usually less than 1 part per 500 million parts of air it would be necessary to run the centrifuge for several hours to collect a sufficient weight of mist. Sampling should be as rapid as possible, for even in a closed chamber rapid changes in concentration take place, owing to coagulation and settling out of the mist.
- (4) It is estimated that a centrifuge running at a suitable speed, with a fairly slow air flow will remove all particles above 0.05μ from the air; even so many particles may escape. This in itself is not a very serious consideration with our mists because the weight of the very small droplets is negligible compared to the whole, but the evaporation effect just described assumes appreciable proportions at as low as 3000 r.p.m., and at this speed a considerable fraction of the mist may escape, especially when fine mists are generated.
- (5) Dust and other impurities are also collected and weighed with the aerosol.

It has been attempted to develop the colour reaction directly upon the paper from the centrifuge, and compare it with known standards, but the colour is far from uniform and the area covered too irregular for even approximate results.

The most satisfactory way of estimating the weight concentration is a filtration method similar to that described by Whytlaw-Gray & Patterson (1932, p. 88) and Whytlaw-Gray & Speakman (1932). It consists in aspirating a sample of the air through a short glass tube about 1 in. long and $\frac{3}{8}$ in. diameter, having a constriction in the middle; a small plug of cotton-wool (or asbestos) is packed into the outer of the two cups formed by the constriction,

the latter preventing the wool from moving under the pressure applied. A known volume of air is drawn through the filter by aspirating for a suitable time, at a known rate of flow, determined by a Venturimeter or Rotameter. We endeavour to make the filter as uniform as possible by taking a constant amount of wool, and packing so that the rate of flow through the filter is a definite amount under standard conditions. In general it is more satisfactory to extract the phenol from the wool with a solvent, and estimate colorimetrically, than to attempt to weigh the filter, due partly to the hygroscopic nature of glycols and partly to dust and other impurities in the air.

It is found that with ammonium chloride smokes weighing will give good results, especially if a similar filter containing wool and similarly treated is used as a counterpoise on the microbalance. The amounts found by weighing agree well with those obtained by extracting and estimating the ammonium chloride chemically. It has also been ascertained that the amount of a mist of hexyl-resorcinol in propylene-glycol collected from an enclosed chamber agrees with the amount atomized into the chamber within the limits expected, if some allowance is made for coagulation and falling out of the larger droplets. The method we use will, therefore, estimate satisfactorily the mist actually present in the air, and it is found that little weight is lost by small particles passing through the filter up to an air flow of about 10 l./min.

A modification of this method may be used to give rapid, approximate results, and which can also be used for extremely dilute mists. The wool filter is replaced by two thick, narrow bore, glass tubes, joined together by a short piece of rubber tubing; a small circle of thick filter paper is placed between the ends of the glass tubes, and held tightly in position by them. The paper is moistened by a drop of $N/50$ NaOH, and a known volume of air aspirated through it. The paper is removed, a drop of diazotized amine or stabilized diazo salt placed on it, and the colour produced compared with a range of standards made by dropping on similar circles of paper single drops of a series of solutions, these solutions being made up in such a way that single drops of them delivered from a calibrated pipette will contain hexyl-resorcinol ranging from 10 to $0.1 \mu\text{g}$. The papers should be allowed to stand for a few minutes in the open air before comparison. As little as 10^{-7} g. of hexyl-resorcinol can be detected in this way, and the results are rapidly obtained, although being at the same time very approximate. In all these colorimetric determinations it is essential that they should be performed in a separate room where no mist has been generated. Grossly erroneous results have been obtained by the contamination of solutions or apparatus when an atomizer has been in use nearby.

Corrosion

In order to obtain an idea of the extent to which the mists studied might affect metal and painted surfaces a number of tests have been carried out with various phenolic materials dissolved in glycols. The general conclusions reached are:

- (a) Benzyl-cresol is more corrosive than hexyl-resorcinol.
- (b) Unprotected iron is the most easily attacked metal of those tested, aluminium and its alloys the least. Copper and brass undergo little visible change.
- (c) Hexyl-resorcinol produces dark stains on paint more readily than the other phenols tested.
- (d) Varnish, "Bitusol" and cellulose paints were unaffected throughout. Undercoats were slightly softened.

The experiments were performed with the materials in contact with the solutions for several weeks. It is not anticipated that any difficulties would arise owing to metals or painted surfaces being attacked by the mists, and for our part we have not noted any effects of this kind in rooms where dense mists are frequently being disseminated.

Tests of new germicides

A number of compounds have been prepared and tested in these laboratories, other than those mentioned in this paper. They include:

- p*-methoxystyrene- ω - ω -dicarboxylic acid.
- 2-methyl-4-hydroxy-5-chlor-benzophenone-2-carboxylic acid.
- o*-, *m*-, and *p*-hydroxyphenoxy acetic acid.
- 2-benzoyl-amino-methoxy-benzthiazole.
- 4-benzoyl-1-3-resorcinol.
- 4-benzyl-1-3-resorcinol.
- 2-hydroxyanisole-3-sulphonic acid (potassium salt), "Thiocoll".

The acids were prepared chiefly with a view to obtaining increased water solubility. None of these compounds, when dispersed in the air, shows a biological activity approaching that of hexyl-resorcinol.

DISCUSSION

We have no evidence whatever to suggest that the vapours of phenolic germicides in the concentrations attainable at room temperature have the slightest effect on bacteria in suspension (cf. Bechhold, 1935). Thus it has been found in these laboratories that mists of the more volatile phenols are ineffective unless the amount produced is more than enough to saturate the available air space, whatever their activity in the test-tube may be. (To this class belong, for example, phenol itself, 4-*n*-amyl-3-hydroxy toluene (R.W. 250), and thymol (R.W. 25).) It is therefore necessary to suppose that an aerial germicide acts by collision, and on this basis it is possible to form a fairly satisfactory picture of the mechanism of the action of germicidal aerosols.

v. Smoluchowski's (1916) hypothesis of coagulation gives for the collision rate between the particles of an aerosol of one kind and a particular particle of an aerosol of another kind the relation:

$$\frac{dn_1}{dt} = \frac{RT}{3\eta N} \frac{(r_1 + r_2)^2}{r_1 r_2} n_1 \left(1 + \frac{AL}{r_1}\right),$$

n_1 = no. of particles/c.c. of the first kind, t = time, R = gas constant, η = viscosity of medium, r_1 = radius of particles of the first kind, r_2 = radius of particles of the second kind, N = Avogadro's number, $A = 0.9$ (Cunningham), $L = \text{m.f.p.}$ in medium, T = Absolute temperature.

If in this equation are substituted values corresponding to an actual experiment in which a bacterial aerosol was sterilized:

Concentration of germicide 10^{-9} g./c.c.

Mean radius of germicide mist particles $r_1 = 0.5 \mu$.

$\therefore n_1 \approx 1.9 \times 10^9$ /c.c.

Mean radius of bacterial particles $r_2 \approx 2 \mu$.

$(R/N = 1.37 \times 10^{-16}$ erg/degree,

$T = 293^\circ$ Abs.,

$L = 2.8 \times 10^{-5}$ cm.),

the average life of a bacterial particle between collisions works out at about 200 hr. This is much too long. Actually the kill took place in 15 min., during which time the germicide particles evaporated to not less than half their original radius. However, Fuchs (1934) has shown that v. Smoluchowski's treatment may be widely in error for aerosols of this average particle size; in fact, the collision rate approaches that in a mixture of two gases as the particle size decreases, and we have found that the application of the gas collision formula gives rates of a more likely order:

$$\text{No. of collisions/c.c./sec.} = 2n_1 n_2 (r_1 + r_2) \sqrt{\left(\frac{2\pi RT}{N} \frac{m_1 + m_2}{m_1 m_2}\right)},$$

m_1, m_2 = masses of the first and second kinds of particle.¹

This gives for the average life in the above example, 1 hr. 40 min., a reasonable value. Actually, even more spectacular effects have been obtained in biological experiments. Germicides of fairly high Rideal-Walker value, but lower volatility than those mentioned on p. 262, effected rapid sterilization of bacterial suspensions when they did so at all. Thus in some instances the propylene-glycol solution of benzyl-cresol in lethal concentration gave complete kills within 5 min.; otherwise, none was obtained. Presumably, this is brought about by the continued production, by evaporation as long as the mist lasts, of fine and therefore highly mobile particles, which at the same time are not too short-lived. The result is in agreement with the observed persistence of droplets of the benzyl-cresol—propylene-glycol solution (Fig. 13).

The biological experiments emphasize the need for a higher collision frequency than is provided by v. Smoluchowski's hypothesis. But all possible formulae agree in indicating that the smaller the germicide droplet, the shorter will be its average life. On the other hand, it has to be remembered that a molecular dispersion, i.e. a vapour, is ineffective. If a bacterium-containing particle, 2μ in radius, is suspended in a mist of 0.5μ particles of a germicide at a concentration of 10^{-9} g./c.c., the weight of germicide material collected by the larger particle (assuming all encounters to result in coagulation) is given by the gas collision formula as:

$$m_1 \times \text{collision frequency per particle} = 8.7 \times 10^{-17} \text{ g./sec. as an average.}$$

¹ The rate of kill can be accounted for by v. Smoluchowski's hypothesis if a sufficiently small active particle is assumed.

If, however, the germicide is present as a vapour, the corresponding figure for the weight colliding with the bacterium is

$$\frac{2n_1 r_2^2 \sqrt{(2\pi RTM)}}{N},$$

M = molecular weight of germicide, say 198 for pure benzyl-cresol, for now $m_1 = M/N$, and m_1 and r_1 are small compared with m_2 and r_2 .

In the example, this equals 2.2×10^{-12} g./sec. Thus 25,000 times as much germicide is available to the bacterium when the former is in the state of vapour, as when it is present as 0.5μ radius droplets, yet it produces no physiological action. Unless the collision efficiency is extremely low so as to account for the very large discrepancy, a factor of quite an unforeseen type must be at work. It is hardly conceivable that a bacterium weighing say 10^{-11} g. could metabolize the germicide sufficiently rapidly not to suffer under a practically continuous molecular bombardment, while the sudden access of a large quantity, occurring in a collision with a mist droplet, destroys it.

In the evaporation of droplets of simple solutions, it has been shown that very frequently the fall velocity-time curve has a straight portion which has a lower gradient than for the solvent alone, yet higher than for the solute. It is possible, though not necessary, that this portion corresponds to the evaporation of a mixture of constant composition. Langmuir (1918) regards the process as a diffusion of vapour outwards from the droplet, the space immediately in contact with the latter being saturated. While probably the first phase type of evaporation is controlled by this mechanism, it is very unlikely that the vapour pressure lowering over a mixture can at any time become large enough to account for the frequently great difference between first and second phase evaporation rates. It is therefore suggested that when a high proportion of the more volatile constituent has evaporated from the surface of the droplet, the factor controlling further loss is no longer diffusion into the gas, but the availability of the more volatile constituent at the surface, depending on diffusion through the body of the droplet. Further, chemical association of the type postulated by Scarpa (1939) may also be effective in causing retention. Otherwise, it is difficult to account, for example, for the straight-line evaporation of particles of 5% glycerol in water (Fig. 25), or for the persistence of the residual droplets from resorcinol-sorbitol-water mixtures; the latter must at least contain a high proportion of resorcinol, and probably some water also.

Germicides of one kind, namely, those which are without effect as aerosols within certain limits, have already been dealt with, and an example of a second kind has been given (benzyl-cresol). Those of the second kind depend for their value on a high phenol coefficient, which enables them to act efficiently during the short lifetime of the droplets. There is a third class, consisting of involatile substances. Almost any compound showing some degree of bactericidal activity is found to give a marked kill, when dispersed as an aerosol, provided that its volatility is sufficiently low, and that it is given sufficient time to act.

The above observations relate chiefly to solutions of phenols in glycols, the latter solvents being most satisfactory from a biological point of view when the phenol is insoluble in water. There is, however, evidence that the solvent plays a more fundamental part in the germicidal action than has been assumed, and given that the volatility of the germicide itself is not unreasonably high, the latter may no longer be of first importance. The outstanding potency of "Aéryl", for instance, is remarkable, since resorcinol has a Rideal-Walker value of only about 0.3. It seems, then, that aerial activity is to some extent a function of the germicide's solubility in water, and this was confirmed by experiments which showed that 50% solutions of calcium and zinc chlorides are more effective than phenol mists (the air in the latter case having first to be saturated with respect to phenol). Even among the glycols themselves, there are noticeable anomalies; mists of ethylene-glycol solutions are nearly always less effective than of propylene, yet their persistences appear not always to be in the order of volatilities of the solvents.

This work is being extended on lines suggested by the considerations of the previous paragraph, namely, the questions of water solubility and of the detailed behaviour of glycol solutions, and methods of analysis are being developed for the determination of constituents in mist droplets.

2. BACTERIOLOGICAL ASPECTS

By A. H. BAKER

Numerous attempts have been made by engineers and others to reduce the number of micro-organisms in the air of buildings by the mechanical means of air washing or air filtration, and by the use of ultra-violet light. We, however, have not been concerned with such methods which are beyond the means of the average home or small institution, but have sought to decontaminate the air by the utilization of germicidal mists. Trillat & Fouassier (1912, 1914) in France, as long ago as 1912, appears to have been interested in the problem. Bechhold (1935) in Germany, and Wells (1935, 1938), Wells & Fair (1935), Wells & Wells (1936, 1938) and Wells & Brown (1936) in America worked in the same field, while Pulvertaft, Lemon & Walker (1939) and Pulvertaft & Walker (1939), as far as we are aware, were the first to publish results of any such work in this country.

Our own investigations on air disinfection, which have been going on since early in 1937, have now reached a stage at which the results may be of use and of interest to the community generally. The large amount of work which we have put into the elucidation of this problem is sufficient to form the basis of a monograph, but in the present paper most of our experimental results will have to be summarized.

The problem was, at first, tentatively studied by the utilization of a particular germicidal mixture (D.X.) in the form of a mist or "aerosol", in an attempt to kill the ordinary saprophytic micro-organisms of the air. "D.X."

was a mixture of 75% thymol and 25% salol, which for air disinfection tests was mixed with terpineol in the proportion of ten parts to seven parts, this mixture being referred to as "D.X.T.2" (p. 295). Preliminary tests in closed rooms soon showed that the question had to be approached warily, step by step. Several failures to reduce appreciably the plate counts by means of a germicidal aerosol in a dusty room, the floor of which was purposely swept to raise the dust, were discouraging. When, however, the agar growths of the organisms collected were suspended in broth, and the suspension dispersed into the air, complete sterilization of all but the sporing types was effected, but the mist was unbearably irritant. At this juncture it became obvious that the problem would first have to be tackled in the laboratory by strictly controlled tests.

THE DEVELOPMENT OF THE EXPERIMENTAL TECHNIQUE

At the beginning of this work we were unable to obtain any guidance from the writings of the Continental or American workers as to the most suitable technique to employ for this type of investigation, and were consequently obliged to develop our own methods.

In view of the difficulty experienced in effecting kills of air-borne saprophytes, and because we were primarily interested in preventing infection from one individual to another, it seemed logical to use a bacterium non-pathogenic to man and for this and other reasons *E. coli* was chosen. The organism, grown on beef extract agar for 18–20 hr., was emulsified in beef extract broth, and standardized to contain 1000 million organisms per ml. Variations in sensitivity due to age of the stock cultures from which the 20 hr. subculture was made may have affected experimental results, but we have not, so far, investigated this point.

A large museum jar of 30 l. capacity fitted with a wooden front, containing a hole for admitting bacterial and germicidal mist and a slot for insertion of culture plates, was set up. The germicidal and bacterial mists were generated by "Atmozon" nebulizers (Fig. 49) operated by a small compressor. These nebulizers can be suspended on a balance and the weight of material lost determined, so that the concentrations of both mists in the jar were calculable. The seeding hole was closed with a stopper, after the admission of the two mists, and 5 min. later the plug was removed from the slot and an uncovered agar plate inserted into the jar, the plug being replaced during the 2 min. of the plate exposure. Similarly plates were exposed at the 10th, 15th, 30th, 45th and 60th minutes. The tests were controlled each day by atomizing the standard emulsion into the jar, in the absence of germicide mist. Control and test plates were incubated for 20–24 hr., and the counts compared.

It was soon found impossible to test low concentrations of germicide mist in the museum jar, and a disused fume chamber with sealed vent was commissioned. The chamber had a capacity of 356 l., and the tests in it were carried out in a similar manner to those just described. It had this advantage over the jar in that the front could be easily raised to allow of thorough airing between tests. This chamber again proving inadequate we had recourse to

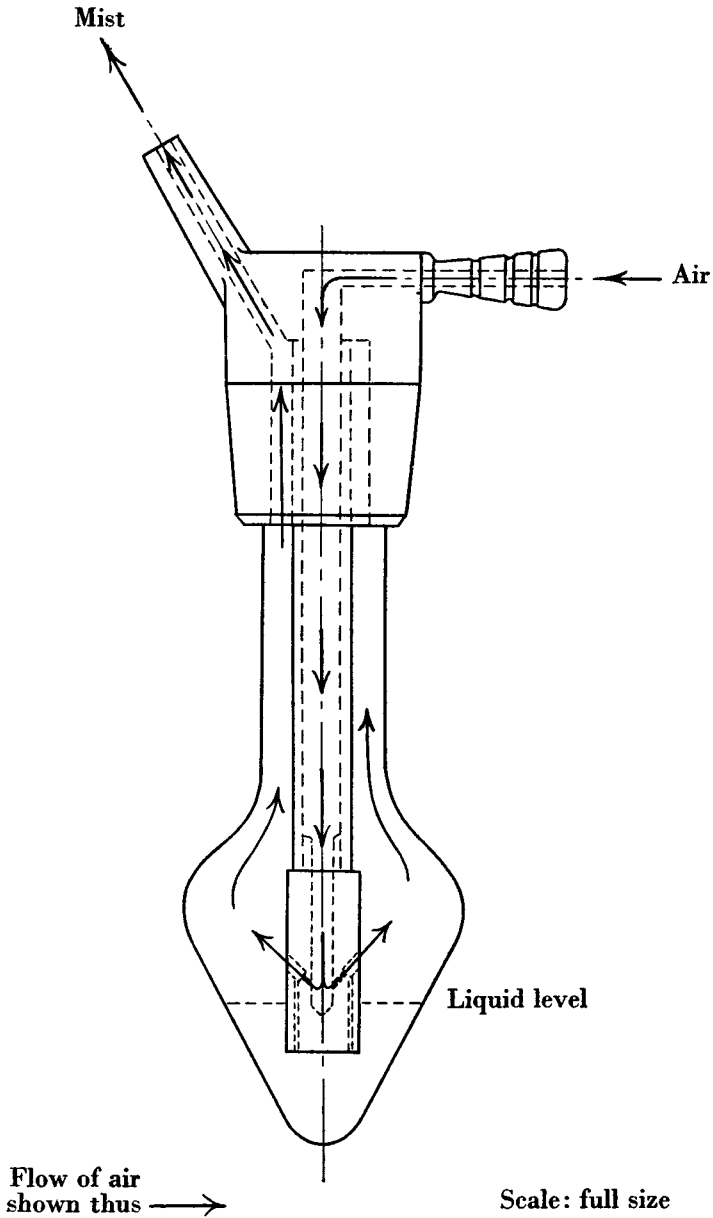

Fig. 49 Diagram of "Atmozon" nebulizer.

a steel and glass cupboard of 1360 l. capacity which, having been made airtight and fitted with the necessary holes and slots, served admirably for some time.

Certain anomalies in the results soon became apparent, and these were mainly concerned with irregularities in the control plate counts. These anomalies were traced in part to growth of the organisms in the broth emulsions, so that when controls were done at periods during the day counts became progressively higher. However, when sterile water was substituted for the broth as a vehicle, similar results were obtained, although when such emulsions were divided into two portions, one being used for tests and the other standing on the bench, no increased counts could be demonstrated in the latter. It was soon discovered that the fault was inherent in the method of atomization, and was due to the passage of considerable volumes of air through the atomizer having a distillation effect on the water.

This effect has been confirmed by passing air dried by CaCl_2 through an atomizer containing 0.1% NaCl solution, and estimating the salt concentration in the residual liquid after varying periods. The concentration after 2 min. was increased by 6%, after 12 min. by 22% and after 30 min. by 40%. Similar tests done with 10% hexyl-resorcinol in propylene-glycol showed like results, the concentration of hexyl-resorcinol increasing by 50% within 20 min., but then appearing to remain constant up to about 1 hr. blowing. When, however, undried air was used, the hygroscopic glycol absorbed water, and the residual solution was found to contain only 4% of hexyl-resorcinol, after 2 hr. blowing. In the atomization of germicides dealt with later in this paper this aspect will be seen to be of the greatest importance, and precautions should always be taken to ensure that dried air is used with the jet type atomizer (Atmozon), and also that the solution should be renewed before any appreciable concentration occurs. With rotary type atomizers it is impracticable to dry the air, and reliance must be placed on frequent renewal of the solution. On the other hand, the distillation or dilution effects are probably less with the latter type of atomizer as the air-flow through the fluid is very much less.

In order to obviate the evaporation of water from our bacterial suspensions we substituted an "Aerograph" air brush, "A.E." model for the "Atmozon" as a nebulizer for the bacteria. In point of fact, this "brush" probably gives a range of particles which simulate mouth droplets more closely since its spray is somewhat coarser than that of the "Atmozon". A measured quantity of fluid can be put into the cup of the "brush" and the whole volume expelled by compressed air.

At this time, using the above technique we were obtaining complete sterility of plates exposed for 2 min. to the mixed bacterial and germicidal mists, when these were allowed to interact for 5-15 min. The concentration of germicide ("D.X.T.2") in the mist form varied from 1 g. in 50×10^6 ml. of air to 1 in 70×10^6 .

As further controls to these tests a series of agar plates was exposed in the chamber at the commencement of each experiment, and removed one by one at the same time as a test plate: that is when at 5, 15, 30, 45 or 60 min. the test plate was inserted and (after 2 min.) removed, the corresponding control plate was removed. In this way the control plates had 7, 17, 32, 47 and 62 min.

instead of 2 min. exposure. Where moderate concentrations of mist (50×10^6)⁻¹, were employed, the control plates of whatever exposure showed practically constant counts. When low concentrations were used a cumulative effect was seen, but in cases where the mists were too strong the longest exposed plates actually showed decreased counts, due to killing of the organisms on the medium. Some typical experimental figures are shown in Table 8.

Table 8. *Showing the number of survivors of E. coli falling on agar plates after varying times of contact with mists of "D.X.T.2"*

Mist concentration in air	Test plates			Control plates		
	5	15	30	5	15	30
Time after admixture of (b) and (g) mists (min.) ...						
Duration of plate exposure (min.)	2	2	2	7	17	32
0	430	168	42	2000	2560	∞
0	2400	1410	210	4000	∞	∞
(0.65 × 10 ⁶) ⁻¹	4	0	0	1000	200	60
(1.3 × 10 ⁶) ⁻¹	0	0	0	∞	∞	∞
(27 × 10 ⁶) ⁻¹	6	2	0	250	—	80
(45 × 10 ⁶) ⁻¹	4	0	0	400	—	480
(90 × 10 ⁶) ⁻¹	170	43	5	2000	—	4000

0 = plates sterile. (b) = bacterial mist.
∞ = uncountable. (g) = germicide mist.

Occasionally even more dilute mists than those shown gave sterility, and doubts were expressed by Mutch, in a private communication (1937), as to whether we were in fact holding the organisms in suspension in the air by means of the germicide mists. The various methods employed to clear up this point will be described.

Several non-germicidal and weakly germicidal fluids were atomized in the chamber in place of "D.X.T.2", and bacterial mists introduced as before. From the results, as shown in Table 9, it was evident that mists of oils or glycerine did not prevent the gravitational fall of the organisms; on the other

Table 9. *The effect of non-germicidal and other mists on E. coli*

Mist concentration in air	Test plates			Control plates		
	5	15	30	5	15	30
Time after admixture of (b) and (g) mists (min.) ...						
Duration of plate exposure (min.)	2	2	2	7	17	32
Olive oil						
(0.7 × 10 ⁶) ⁻¹	1700	1100	300	∞	∞	∞
Glycerine						
(0.3 × 10 ⁶) ⁻¹	4000	1900	650	∞	∞	∞
(3.7 × 10 ⁶) ⁻¹	800	200	113	∞	—	∞
Terpineol						
(15 × 10 ⁶) ⁻¹	53	11	11	∞	∞	∞
(0.04 × 10 ⁶) ⁻¹	0	0	0	310	—	300
Phenol (95%)						
(1 × 10 ⁶) ⁻¹	0	0	0	0	0	0

0 = plates sterile. (b) = bacterial mist.
∞ = uncountable. (g) = germicide mist.

hand, both terpineol and phenol had definite bactericidal action in high concentrations. The use of the Sedgwick-Tucker aerobioscope in its original form, or in its various modifications, also proved the point, since so long as colonies could be demonstrated on test plates, then living organisms were recovered in the Sedgwick-Tucker tubes, and when sterile plates were obtained, then the tubes were sterile. A third test employed was the exposure of micro-slides on the floor of the chamber. After several minutes' exposure the slides were stained and the bacilli were clearly demonstrable.

It was thought that the Sedgwick-Tucker tube extraction method might prove a more reliable criterion for enumerating the survivors in our tests, and a considerable number of experiments was carried out using this method together with plates; but we concluded from our results that, in the still atmosphere of the chamber, the plate method was more reliable and very much simpler. We were unable to obtain constant counts with the tubes in spite of trying sterile sugar, sand and sodium sulphate as filtering agents. The probable reasons for this failure would seem to be that (a) sugar and sodium sulphate are germicidal to *E. coli*, (b) it is impossible to wash a constant proportion of organisms from sand, and (c) when germicide mists were also present the particles were trapped and concentration of the germicide so collected thus caused death of the organisms. The same difficulties arose when similar tests were carried out with *Staph. albus* and *Str. faecalis*. Other aspiration methods tried were those of bubbling the air through a silk-covered tube immersed in sterile water, or alternatively a G. 4 sintered glass filter immersed in sterile water. Both methods failed, probably for the same reason as the sand tubes.

The Wells (1936) air centrifuge (Air Analysis Subcommittee, 1937) was found to be an excellent instrument for determining the bacterial content of air, particularly so in rooms and buildings, but in the closed atmosphere of our chambers the method was not superior to plate exposure and involved a little more manipulation.

At this juncture we reviewed the whole situation, and came to the following conclusions:

- (1) Sterilization of *E. coli* in the air had been accomplished.
- (2) The experiments should be extended to include representatives of the naso-pharyngeal organisms.
- (3) The tests should be more rigorously controlled and standardized.

It was obvious that much work lay before us, and it was therefore decided, on Prof. F. W. Twort's advice, to construct two identical chambers, one of which should act always as control to the other.

Construction of the twin chambers

The chambers, large cylinders standing on end on brick piers, were constructed of wood, and lined inside with polished lead sheet. Corners and ledges which would make for air pockets were eliminated as far as possible, and for the same reason the ends were dished. Pls. VI-VIII illustrate the twin chambers which are housed in a room of which the temperature

is thermostatically controlled at 65° F. The internal measurements of the chambers are: height 183 cm., diameter 145 cm., giving a volume of approximately 3050 l. each. Items not seen in the photograph are the small fans (one in each chamber) which are set in the top, the motors being external; windows to admit light from 100 W. lamps, also on top and external; and vent pipes which are led away through the wall and continue to the top of the building. About 6 ft. above the point of exit of the vent through the wall four electric bar heaters are housed: these are used to facilitate rapid ventilation of the chambers, and also serve to destroy pathogenic organisms before they can reach the open air. In the bottom of each chamber is fitted a valve-controlled outlet for use when washing down.

All removable parts other than the plugs *P* are fitted with jointing washers, and kept in place by wing nuts. The inoculation and sample holes *P* are closed with rubber bungs fixed on T-shaped metal handles. At the junction of the two chambers are fitted two machined slide valves *S* which are opened just prior to the commencement of the tests to ensure equality of atmospheric conditions in both control (1) and test (2) chambers. No effort has been made to control atmospheric conditions other than temperature, but "Humidigraph" tracings are taken in the room for reference at any time.

The Petri dish carriers (*C*), of which there are two in each chamber, can hold twelve plates each, and for convenience were made in two sections hinged together at the centre. These carriers slide on two metal rods situated about 25 cm. from the bottom of the chamber; *C'* is shown in the closed position and *C* (containing two dishes) is seen in the loading position. The rod *R*, working in a ball-and-socket sleeve which can be orientated within limits, is used for removing the Petri dish covers. By rotating this rod through a half circle it can be used for plates on either carrier. As the L-shaped end comes to the centre of the carrier it is moved to engage in the hole of the clips (Pl. VIII) on the Petri dish lid. These clips being made of springy brass fit the lids snugly, but are easily removed before incubating the plates.

Air sterilization tests in the twin chambers

By means of the plate carriers described in the preceding paragraph the chambers are loaded with the required numbers of plates, previously labelled and fitted with clips. All shutters are closed, one plug *P* is removed and the fan switched on. Bacterial mist is introduced from the "Aerograph" air brush into the control chamber through plug-hole *P*, and at the same time a stop-clock is set going. Immediately after this the germicide mist is blown into the test chamber followed, at 1 min. on the stop-clock, by the bacterial mist. As soon as each chamber is charged the fans are stopped and the plugs *P* inserted. With the aid of the movable arm *R* the first control plate is exposed at 5 min. on the clock and the first test plate at 6 min. Other plates are exposed at 15, 30, 45 and 60 min. after the atomization, each plate being exposed for 3 min., with the exception of the 60 min. ones which are given 5 min. exposure. The chambers are then aired by opening the top slides and removing the plate-carrier covers, airing being continued for at least 20 or 30 min. Despite this airing period we have good evidence that "building up" of germicide (cf. p. 318) occurs in some instances, and although we are not in a position to make quantitative allowances for this, the fact is considered in assessing the potency of any substance under test. In the meantime, the plates are taken to the incubator when the clips have been removed, and a further set of plates prepared for the next test.

A considerable number of tests was undertaken to ascertain the best concentration of organisms with which to work. It seemed necessary to use the greatest number practicable in order to make the tests as stringent as possible. Concentrations varying from 1000 to 100,000 bacteria per litre of air were tried, and it was found that the best results were obtained with most types of organisms when 10,000 per litre of air were present, the first control plates usually giving a countable number of colonies while those at the end

of 1 hr. still showed a sufficient number to be of statistical use. This concentration of 10,000 organisms per litre of air (far in excess of anything likely to be encountered in practice), was obtained by standardizing the emulsions to contain 150 million organisms per ml. (Brown's opacity tubes) and utilizing 0.2 ml. of such suspensions for each chamber.

We wished to satisfy ourselves that we were obtaining constant fall rates for the various organisms used, and to this end the following tests were devised. The chamber was charged with plates, the lid of one being removed just prior to nebulizing 0.2 ml. of the standard bacterial emulsion, and replaced 30 sec. from the start of nebulization. At the commencement of the 2nd, 4th, 6th, etc., minutes other plates were exposed for 30 sec., and so on for 30 min., sixteen plates in all being used. From the averages of successive counts the numbers falling in the intervening periods of $1\frac{1}{2}$ min. were calculated, and thus the total number of viable organisms falling on one plate area in 30 min. could be calculated. Knowing the plate area (50.03 sq. cm.) and the height of the column of air (155 cm.) above each dish the constant was found to be approximately 7.8 (litres), so that given 10,000 organisms per litre of air the maximum theoretical number available per plate is 78,000 at the commencement of a test. The actual numbers of viable organisms in the original suspensions were also estimated, and found to vary within the limits usual in such suspensions however constant the factors are kept. No attempt was made to take account of the non-viable organisms for reasons which will be obvious from later work.

Where rather crowded plates were obtained it was feared that our calculations might have been upset by superimposition of colonies, and although the appearance of the colonies gave little evidence in support of this the matter was cleared up by exposing plates of broth concurrently with the agar ones. After exposure the broth was mixed with an equal volume of double strength watery agar, and the whole allowed to set. Comparisons of the counts on the two sets of plates showed that there was very little difference, in fact in most instances the "broth" plates showed 10-15% fewer colonies than did the agar plates, and this perhaps can be assigned to the fact that the organisms used, *E. coli* and a saprophytic micrococcus, could not grow so readily in "pour" plates.

Certain other tests were performed to determine roughly for how long organisms could be demonstrated in the air of our chambers. The various types of organisms tested could be found up to 2 hr., which was the maximum time at which plates were exposed. One exception appeared in the case of *P. avisepticus* which seemed particularly susceptible to desiccation, viable organisms often disappearing in between 30 and 45 min.

Selection of test organisms

In view of the numerous tests it was probable we should have to perform, it appeared desirable to confine our investigations in the first place to organisms non-pathogenic for man. A list of some thirty was selected, and *in vitro* tests

performed to enable the organisms to be tabulated in order of resistance to phenolic bodies. A detailed description of these tests is given later (p. 335). From the list were chosen members, both coccal and bacillary, Gram-positive and negative, as follows: *E. coli*, *B. lactis aerogenes*, *C. xerosis*, *Str. agalactiae*, "F" coccus, *P. avisepticus*, *M. phlei*. Of these all were standard strains (National Collection of Type Cultures) except *E. coli*, which was isolated in our own laboratories from faeces, and the "F" coccus which is a Gram-positive, white micrococcus isolated from a foodstuff, and proved to have a resistance to phenolic compounds similar to that of several strains of pyogenic streptococci.

With the exception of *P. avisepticus* all the foregoing organisms were cultivated on standard "Bacto" Beef extract agar. The addition of 5% normal horse serum was necessary for growing *P. avisepticus*. Emulsions for test were made from 18–20 hr. growths, except in the case of *M. phlei*, where 4–5 day growths were used.

In addition to testing the above organisms grown on agar and suspended in Reddish's broth, emulsions were made in the broth to which had been added 5–20% of normal horse serum, while in some instances the organisms were grown on 5% serum agar or emulsified in sterile saliva (human saliva heated at 60° C. for 1 hr.). Again, further tests involving the utilization of untreated, normal human saliva were carried out, and it is on these tests that our final appraisal of a germicide is based, since such an innoculum is probably the nearest approach to that which would have to be dealt with in everyday practice.

The germicides

Once we were satisfied that the biological technique was fully under control attention was directed to checking the mist concentrations of the germicides. In the early days, as previously described, we were content with weight differences of the atomizer for calculating the mist concentrations, and while it is not the purpose in this section to describe in detail the chemical and physical aspects of the problem, certain points must be mentioned.

Among the methods of chemically estimating the presence of phenolic bodies, that employing a diazotizing reagent was found to be the best for our purpose. The atmosphere under test was sampled either by the use of an evacuated flask or by aspirating slowly a known volume of air through alcohol. Both methods have their limitations. In the former case it is impracticable to use a container of greater capacity than about 4 l., while in the case of the latter, aspiration being a slow method, a certain proportion of mist is lost by condensation in the chamber during aspiration, and especially is this so when the mist particles are large. Final limitation of the chemical estimation lies, of course, in the sensitivity of the reaction, it being found possible by these methods of collection (cf. p. 287) to estimate certain phenols when present in concentrations of $(50 \times 10^6)^{-1}$ with an upper limit of $(100 \times 10^6)^{-1}$, but at this latter strength the colour reaction is so transient that comparisons with standards came near to being guesswork. Other factors influencing the estimations of low concentrations were found to be the presence of smoke, dust and CO₂ in the atmosphere.

The question of "falling out" or condensation of the bactericide mists naturally led us to consider ways and means of stabilizing our mists. It was obvious that mists of very small particles should remain in suspension longer than those of larger size, but to what lower limit were we confined? The mechanism of air disinfection appeared to be that of contact and coalescence of bacterial and germicidal particles, for only on such grounds could the action of dilute mists be explained. Bechhold (1935) had postulated that weight for weight germicides were more efficacious in mist dispersion than in molecular (vapour) dispersion, and indeed, we ourselves have ample evidence that this is so. Was it not possible, therefore, that if the particle size were too small one such particle would not contain a lethal dose? Elucidation of these points culminated in two separate lines of investigation:

- (1) Determination of the lethal dose of germicide per single organism (p. 336), and
- (2) Physical behaviour of mists.

A large amount of data on the latter point has been accumulated by our colleagues, Messrs Finn and Powell, and is reported in their section on the physical aspects of air disinfection, wherein is shown the relationship between the persistence of mists, particle size, and volatility of the bactericide bases and of the solvents we have employed. These considerations cleared up many hitherto inexplicable anomalies in our early results, and biological findings appear always to run parallel to the rate of evaporation of the mist, other factors being equal.

When full analysis was made of the result with the germicidal mixtures of thymol and salol, we were faced with the question of what should be expected of such a process as "air disinfection": that it was possible of accomplishment was evident, but was it a practicable proposition? We therefore drew up a list of the properties to which we considered the mists, in concentrations lethal to bacteria, must conform, and these were:

- (1) Non-irritant to eyes, skin, lungs and nasal mucosa.
- (2) Non-toxic to man, even after continuous exposure.
- (3) Invisible.
- (4) Inodorous.
- (5) Non-corrosive.
- (6) Non-inflammable.
- (7) Persistent.
- (8) Rapidly lethal to bacteria.

The last property has, perhaps, been the most difficult to attain, since even yet we are not in a position to state whether any "kill" as assessed by cultural methods is necessary. That is to say, a pathogenic organism, while still capable of reproduction on laboratory media, may have been rendered avirulent or at least so attenuated that it would fall an easy prey to the natural defences of the body. As a matter of fact in some tests we have observed that the colonies produced by treated organisms are smaller than those of the

corresponding controls. It is unfortunate that the present emergency has so far prevented our carrying out crucial animal infection experiments on this aspect.

Germicidal mixture D.X. had to be abandoned because it did not conform to several of the above requirements, and we were thus compelled to search for other substances. We naturally turned our attention to those of high germicidal activity as judged by the Rideal-Walker value. For reasons which at the time were not apparent, this desideratum of high Rideal-Walker value was partly fallacious.

The following index of germicides (Table 10) with their Rideal-Walker values will be a guide to the tabulated results of their effect as aerial disinfectants:

Table 10

Substance	Rideal-Walker coefficient
"Aéryl"	0.11
Amyl-meta-cresol	250
Benzyl-cresol	105
Cresantol 3	95
"C.B.P."	150
Hexyl-resorcinol	57
Penta-chlor-phenol	?
Penta-chlor (Na salt)	<10
Para-chlor-meta-cresol	35
Para-chlor-meta-xylenol	65
Phloroglucinol	0.3
Resorcinol	0.3
Tertiary butyl-phenol	5.9
Tertiary octyl-phenol	<1*
Thymol	25
Thymol + salol (D.X.)	38
"62198"	<1
"62199"	<1
"62200"	<1
"S ² "	4.7
CaCl ₂	<0.1
ZnCl ₂	0.4

* Stated to be *p*-tertiary octyl-phenol. Niederl *et al.* (1938) give 158 as the R.-W. coefficient.

Reference has already been made to the evaporation rate of solvents (p. 261). Now, with the exception of benzyl-cresol, "Cresantol 3", amyl-meta-cresol and "C.B.P.", all the germicides tested were solids, and therefore suitable solvents had to be selected. Most of the germicides were known, or found to be, too poorly soluble in water for our purpose, so that our attention was turned to organic solvents. These solvents, of course, had to conform to the characteristics laid down for the germicides, and in addition we assumed that volatile solvents would not be suitable, as we should have a residual mist of solid particles which would very likely be inactive. It was not until our colleagues had carried out certain tests that we appreciated how rapidly certain fluids, relatively involatile in bulk, could evaporate from mist particles. In spite of this factor, however, several substances were tested in alcoholic solutions and found to be active, though considerably less so than in certain

other solvents. This observation may possibly be explained by the fact that the residual particle of pure germicide base remained in the super-cooled, fluid state after evaporation of the alcohol; possibly residual traces of alcohol might facilitate this condition.

The various solvents we have employed are ethylene-glycol, propylene-glycol, diethylene-glycol, carbitol, cellosolve, glycerol, terpeneol, alcohol (industrial spirit), benzyl-benzoate, benzyl-alcohol, cyclohexanol, and mixtures of glycol and water, and glycol and spirit. From the biological results it was evident that we could eliminate certain of these substances as useless, others were given up on the score of odour or high toxicity to mice, and we were eventually left with the ethylene- and propylene-glycols and glycerol. It has not been possible to test each germicide in every solvent, nor has it been possible to test every solution against all members of our selected list of organisms. By a process of elimination we were able to reduce our germicidal solutions to four, viz. benzyl-cresol (1) in ethylene-glycol, (2) in propylene-glycol, hexyl-resorcinol, (3) in ethylene-glycol and (4) in propylene-glycol.

METHOD OF RECORDING AND EVALUATING EXPERIMENTAL RESULTS

Before giving details of our experimental findings it will be advisable to trace our methods of obtaining figures suitable for comparison.

The testing of the germicidal value in the air of a germicide consists of five or six separate tests each with its own control. Each test yields three or five plate counts in both test and control, according to whether the test is of 30 or 60 min. duration. Table 11 shows a typical result, with the percentage survivors worked out for each pair of plates. If the 1 hr. period is taken as a standard then it is possible by finding the average number of survivors present on the five plates to give our results as the mean percentage survivors over the hour period for each test; this percentage (although not so in Table 11) is often very similar to that found on the half-hour plate if the kill is continuous during the whole hour.

Table 11. *Method of recording a test*

Plate min.	Control col.	Test col.	Percentage survivors
5	1210	1210	100
15	640	120	18.7
30	390	15	3.8
45	260	1	0.38
60	66	0	0

Mean percentage survivors over 1 hr. = 24.6.

As experimental results accumulated it was cumbersome to have to compare each of one set of tests with those of another set. Furthermore, in repeating certain tests for corroboration it was not always possible to repeat the germicidal mist concentrations exactly, and so to obtain strict comparisons. After a survey of numerous results from the use of one germicide it was found

that by reducing the mean percentage of survivors of each test to a mist concentration of 1 part in 100 million parts of air a fair basis of comparison was arrived at as between each test in a set and between different sets (Table 12). This method is based on the assumption that the percentage of surviving bacteria is inversely proportional to the mist concentration of germicide, experiments where there is no kill being excluded. It will be appreciated that in the event of the mean percentage of survivors over the 1 hr. period being greater than the reciprocal of the number representing the dilution in millions of parts of air of the mist concerned, then the final figure obtained would be over 100. Thus a $(50 \times 10^6)^{-1}$ mist giving 60% survivors or a $(25 \times 10^6)^{-1}$ giving 30% survivors would show a final figure of 120, or in other words, such a germicide put up in a mist concentration of $(83 \times 10^6)^{-1}$ would give no kill.

Table 12. *Six test results reduced to terms of $(100 \times 10^6)^{-1}$ mist and expressed as one figure*

Mist concentration 1 part per 10^6	Mean percentage survivors	
	In 1 hr.	As $(100 \times 10^6)^{-1}$ mist
3200	23.5	0.72
1600	13.5	0.84
800	17.6	2.20
400	8.8	2.20
200	6.66	3.33
100	2.8	2.80
	Mean	2.02

In order to see whether the percentage of survivors found at the 5 min. interval, when compared with those obtained over the hour period, would alter the position in order of merit of our germicide mixtures, figures for twenty sets of experiments were worked out both ways, and the correlation coefficient determined. The two sets of figures examined by the ranking method gave 97% of perfect correlation.

As the 1 hr. figures are derived from the average of five different time intervals it follows that where the kill is complete in 15 min. (the second plate) theoretically the final figures obtained when dealing solely with the 5 min. plate can never be more than five times that of the 1 hr. mean figure, while when there is no further kill after 5 min. the multiplication factor cannot be less than one.

SOME EXPERIMENTAL RESULTS

In Tables 13 and 13a are shown the results of forty-eight germicidal mixtures tested against the "F" coccus and other organisms under the conditions previously explained, the figures being arrived at according to the methods outlined in the preceding paragraphs.

When the tests for selecting suitable germicidal mixtures were being carried out the "F" coccus, for reasons given earlier, was employed in the majority of the primary tests. On comparing the results with this organism it will be

Table 13. *The approximate mean percentage number of survivors of the "F" coccus in broth emulsions treated with germicides in mist concentrations of 1 part in 100×10^6 parts of air over the 1 hr. period*

Germicide	Percentage	Diluent-solvent	Survivors
Benzyl-cresol	100	0	0
"	10	Ethylene-glycol	2.36
"	2	Ethylene-glycol	8.64
"	1	Ethylene-glycol	32.18
"	*10	Cyclohexanol	0
"	2	75% ethylene-glycol in water	23.65
"Cresantol 3"	10	Methylated spirit	3.022
"	10	Benzyl-alcohol	39.78
"	10	Benzyl-benzoate	60.0
"	10	Terpineol	0.18
"	1	Methylated spirit	1.60
"	1	Methylated spirit + 10% ethylene-glycol	3.33
"	1	0.1% Turkey red oil in water	100.0
Hexyl-resorcinol	50	Ethylene-glycol	0.42
"	40	Cyclohexanol	0.73
"	10	Ethylene-glycol	0.61
"	*10	Propylene-glycol	0.20
"	10	Methylated spirit	1.69
"	5	Methylated spirit	2.18
"	10	Benzyl-benzoate	5.70
"	10	25% watery propylene-glycol	7.18
"	10	50% glycerine in water	4.85
"	5	Propylene-glycol	1.85
"	2.5	Propylene-glycol	15.9
"	10	Propylene-glycol + 1% benzyl-cresol	0.31
"	10	Propylene-glycol + 0.005% brilliant green	0.07
"	10	Propylene-glycol + 0.1% sulphonated lorol	0.28
"	*10	Propylene-glycol + 0.05% lorol = S ²	0.11
"	10	Propylene-glycol + 0.01% lorol	0.46
"	5	Propylene-glycol + 0.05% lorol	1.12
"S ² "	100	+ 0.005% brilliant green	0.74
"	*100	+ N/100 NaOH	0.047
Resorcinol	10	5% watery glycerol	27.0
"	10	5% watery glycerol + 0.05% lorol	11.9
"	10	Propylene-glycol	67.0
"	5	Propylene-glycol	100.0
"Aéryl"	100	0	1.39
"	100	+ 0.05% lorol	2.02
Amyl-meta-cresol	10	Propylene-glycol	53.32
"	10	Propylene-glycol + 5% glycerol	70.0
"	10	Propylene-glycol + 5% glycerol + 0.05% lorol	60.0
Para-chlor-meta-xyleneol	10	Propylene-glycol	17.42
Para-chlor-meta-cresol	20	Propylene-glycol	17.42
Penta-chlor-phenol	10	Ethylene-glycol	19.9
"	10	Benzyl-benzoate	64.0
Phloroglucinol	10	Propylene-glycol	70.0
Tertiary butyl-phenol	50	Ethylene-glycol	44.0
"C.B.P."	10	Propylene-glycol	70.0

Table 13a. Percentage survivors of some other micro-organisms, as Table 13

Germicide mixture	<i>C. xerosis</i>	<i>M. phlei</i>	<i>E. coli</i>	<i>B. lact. aerog.</i>	<i>P. avi-septicus</i>	<i>Str. agalactiae</i>
Benzyl-cresol in ethylene-glycol	—	—	2.14	1.28	—	—
Benzyl-cresol in propylene-glycol	—	26.71	15.5	17.0	14.64	—
"Cresantol 3" in ethylene-glycol	1.042	—	1.75	—	—	—
"Cresantol 3" in propylene-glycol	—	—	—	39.5	—	—
Hexyl-resorcinol in ethylene-glycol	2.61	—	0.76	—	—	—
Hexyl-resorcinol in propylene-glycol	0.51	6.85	1.01	4.50	—	—
"S ² "	0.28	0.29	0.07	0.45	—	3.15
"Aéryl"	—	—	7.08	—	—	—

seen that benzyl-cresol and hexyl-resorcinol in those mixtures marked with an asterisk are outstandingly good. However, because we found that benzyl-cresol, even when diluted with ethylene-glycol, was too irritant, we were forced to concentrate our attention on the hexyl-resorcinol solutions.

If the results with a germicide in the different solvents are compared *inter se*, it will be clearly seen to what extent the solvent can affect the activity. So far we have been unable to assign any reasons for these differences. At one time it was thought that water miscibility of the solvent, besides its possible effect on the time lag of the kill (pp. 307, 308), might be the chief factor influencing the degree of kill, but this does not appear to be so, since both cyclohexanol and terpeneol, for example, gave better results than alcohol. Neither can the difference between the glycols be similarly explained, although water solubility of both germicide and solvent is presumably a desirable property in air sterilization as it is in other spheres of disinfection.

Again, it is somewhat difficult to account for the falling off of the kills, at least in the case of hexyl-resorcinol, as the germicide base is progressively diluted with more and more solvent, in view of the findings of our colleagues as regards persistence of the mists, considered in conjunction with the known Rideal-Walker value of the germicide base. Let us take the case of the 2.5, 5 and 10% solutions of hexyl-resorcinol in propylene-glycol, where the ratio of the quantity of base present is 1 : 2 : 4, while that of the percentage of survivors is 15.9 : 1.85 : 0.20. These figures mean that the dilution end-point where no kill was registered was approximately 1 part of mist in 600×10^6 , 5200×10^6 and $50,000 \times 10^6$ parts of air respectively, giving a ratio of the order of 1 : 10 : 100.

Evidence of the effect of volatility of the germicide base is seen in the results given by benzyl-cresol, amyl-meta-cresol and "C.B.P", with their Rideal-Walker values of 105, 260 and 150 respectively. These substances are 2, 5 and $1\frac{1}{2}$ times more effective *in vitro* than hexyl-resorcinol, yet they do not compare with the latter for air sterilization purposes, as will be seen from scrutiny of Tables 13 and 13a.

During the period when we were working with benzyl-cresol and hexyl-resorcinol the proprietary product "Aéryl" was brought to our notice, and as great claims were made for it we decided to perform tests for ourselves. Such tests, on the whole, substantiated the claims made by the manufacturers, but we shall discuss the pros and cons of "Aéryl" and other germicidal mixtures in detail later (pp. 312, 339) in this communication.

In connexion with water miscibility and volatility we would mention that two inorganic salts, viz. CaCl_2 and ZnCl_2 have been utilized in the mist form. These salts, both deliquescent, and having Rideal-Walker coefficients of <0.1 and 0.4 respectively, were prepared as 50% W/V solutions in water, and tested as aerosols against Saliva "A" (p. 310). The lowest mist concentrations which showed appreciable kills within the hour were:

CaCl_2	$(37 \times 10^6)^{-1}$	12.2% survivors
ZnCl_2	$(54 \times 10^6)^{-1}$	22.7% survivors

These findings are significant when compared with a 50% W/V solution of thymol in ethylene-glycol, which in a mist concentration of $(42 \times 10^6)^{-1}$ gave a 40% "kill" of an atomized broth emulsion of our standard "F" coccus. Now thymol has a Rideal-Walker value of about 25-30, which means that *in vitro* it is at least 250 times more germicidal than CaCl_2 and approximately 65 times stronger than ZnCl_2 , so it seems likely that its high volatility and low solubility in water (1/1000) may be the explanation of the difference between its effectiveness as a germicidal aerosol, and the action of ZnCl_2 and CaCl_2 under similar conditions. Watery solutions of several germicides were tested, but they mostly only showed evidence of "kill" in concentrations exceeding $(100 \times 10^6)^{-1}$, and even in much higher concentrations the "kill" was not complete. Phenol, thymyl acetate, sodium penta-chlor-phenol and sodium hypochlorite were among the substances so tested, and a 95% solution of phenol, for example, only gave a 16% mean "kill" over the hour period, when in a mist concentration of $(40 \times 10^6)^{-1}$.

Minimal effective concentration of germicidal aerosols

The results as recorded in terms of mist concentrations of $(100 \times 10^6)^{-1}$ give no indication of the extreme dilutions of mist which, in many instances, have been employed to obtain sterilization. In the case of "S²" versus the plain broth emulsions some measure of kill has been noted with mists of 1 g. in $300,000 \times 10^6$ ml. of air, representing the fantastic dilution of 1 g. of hexyl-resorcinol in 3×10^{12} ml. of air. In fact, we have not been able to obtain the end-point in this direction. Mists of $(10,000 \times 10^6)^{-1}$ may give between 1 and 2% survivors after only 5 min. contact, with absolute sterility at 30 min. On the other hand, "Aéryl", which on analysis was found to be composed of resorcinol, 45.3%, glycerine 7%, water 47.7% and 0.01% of brilliant or similar shade green, and like solutions of resorcinol usually fail to show any kill in mist concentrations greater than approximately $(400 \times 10^6)^{-1}$.

Killing rate of germicidal aerosols

The time taken for the germicide to destroy or render innocuous the bacterium with which it comes into contact in the air is, of course, of prime importance. The time lag before a kill is effected, while in the test-tube depending upon the potency of the germicide as such, would seem in the air to depend more on water miscibility and involatility. We have just remarked upon the difference between "Aéryl" and "S²" as regards retention of effectiveness on dilution of the mists with air, but there is also the difference in that, any kills shown by resorcinol solution mists take place fairly rapidly or not at all, whereas mists of hexyl-resorcinol solutions have a greater tendency to show progressive kills.

The following figures (Table 14) from actual tests illustrate this point more clearly, although in no other way are these results comparable, "S²" consisting of 10% hexyl-resorcinol in propylene-glycol + 0.05% sulphonated loral.

Table 14

Minutes of contact	5	15	30	45	60
"S ² " mists (517 × 10 ⁶) ⁻¹	72.0	51.2	20.3	4.4	1.4
"Aéryl" mists (193 × 10 ⁶) ⁻¹	8.0	0.7	0	0	0
"Aéryl" mists (332 × 10 ⁶) ⁻¹	96.0	83.0	72.0	33.0	71.0

The figures represent the mean percentage number of survivors over the 1 hr. period. "Aéryl" is, of course, much more readily miscible with water, and, as a matter of fact, is also much more volatile than S². As regards volatility, however, the most outstanding difference is seen when comparing results given by such germicides as benzyl-cresol and hexyl-resorcinol. The relatively highly volatile benzyl-cresol may give a high percentage kill within 5 min. in a mist concentration which when halved will hardly have any effect at all in an hour. A related proprietary product, "Cresantol 3", acts similarly, while as we know it is with the greatest difficulty that we manage to get a rapid kill with hexyl-resorcinol, although this germicide is capable of showing a definite lethal effect on bacteria in enormous dilutions, given time to exercise its toxicity.

The rate of kill of the "F" coccus by "Cresantol 3" during the hour was worked out by finding the average percentage number of survivors at the 5th, 15th, 30th, 45th and 60 minutes of forty-five experiments. It was found that the killing rate after the 5th minute was practically nil, the percentage number of survivors at the several time intervals thereafter being almost identical. A similar examination of a series of experiments with hexyl-resorcinol, as will be understood, showed a progressive kill during the whole course of the experiments.

The effect of protein matter on the action of certain germicides (Table 15)

From the experimental results recorded in Tables 13 and 13*a*, and for the other reasons stated, it will be seen that we needed only to consider hexyl-resorcinol and "Aéryl" as suited to our purpose. We anticipated that the

presence of organic matter such as serum, saliva, etc., in the bacterial mists, as in the test-tube, would have a damping effect on the germicidal mist, and, therefore, tests were carried out with bacterial suspensions containing added horse serum or saliva. In addition to utilizing bacterial suspensions containing extra organic matter, some tests were carried out with isotonic saline and distilled water suspensions. The primary object of these tests was to determine whether complete desiccation of the organisms in the case of atomized distilled water suspensions or partial desiccation in the case of atomized saline suspensions (NaCl being slightly hygroscopic) had any influence on the rate or degree of kill. In another experiment, not recorded in the tables, the organisms were emulsified in distilled water containing 5% propylene-glycol, this strength of glycol being quite innocuous to the organisms *in vitro*. It was expected that the mist particles would retain some water, due to the hygroscopicity of glycol. This test was a failure, since the control counts were almost nil in 5 min. and nil in 30 min. No doubt the water evaporated instantaneously, leaving behind concentrated glycol which *in vitro* had been shown to be lethal in 10 min., at a strength of 75%.

Table 15. *The effects of serum and saliva, etc., on survival rates of bacteria in air treated with germicide mists*

Germicide	Organism	Broth	Suspension			G/S	Saliva		
			H ₂ O	Saline	B + 5% S			B + 10% S	B + 20% S
10% hexyl-resorcinol in propylene-glycol	"F" coccus	0.20	2.69	3.40	12.9	—	25.6	1.01	—
5% ditto	"	1.85	—	—	—	—	19.6	—	—
10% hexyl-resorcinol in ethylene-glycol	"	0.61	—	—	16.0	—	26.1	1.11	—
10% benzyl-cresol in propylene-glycol	"	—	—	—	100	—	100	2.41	—
10% benzyl-cresol in ethylene-glycol	"	2.36	—	—	5.12	—	14.45	—	—
5% ditto	"	—	—	—	24.62	—	100	2.21	—
"S ² "	"	0.11	—	—	—	2.93	—	—	0.75
"Aéryl"	"	1.39	—	0.06	—	4.23	—	—	0.27
"S ² "	<i>Str. agalactiae</i>	3.15	—	—	—	36.75	—	—	6.97
"	<i>C. xerosis</i>	0.28	—	—	—	11.36	—	—	2.84
"	<i>B. lactis aëro- genes</i>	0.45	—	—	—	5.22	—	—	38.0
"	<i>E. coli</i>	0.07	—	—	—	5.01	—	—	0.14
"Aéryl"	"	7.08	—	—	—	2.78	—	—	—

B = broth. S = serum. G/S = grown on serum agar.

The results of the above tests shown in Table 15 are calculated on the same basis as those in Tables 13 and 14 and show clearly the effect of serum and saliva on hexyl-resorcinol mixtures. The germicide "S²" was evolved in an attempt to improve the kill by hexyl-resorcinol, particularly in the presence of organic matter. The lorol was added as a "wetting" or "spreading" agent. It can be seen that this solution gives, roughly, only half the number of survivors given by the plain 10% solution of hexyl-resorcinol. Table 15 also shows the relatively mild damping effect of serum on the germicide "Aéryl" as compared to that on hexyl-resorcinol mixtures.

The effects of bactericidal mists on nebulized saliva

We regarded the dissemination of mists of normal, untreated human saliva and attempts to reduce the number of viable organisms therein with bactericidal mists as the most feasible approach in the laboratory to conditions which would obtain in practice.

The tests with saliva were carried out in the twin chambers, using the technique previously described. Standard blood agar (M.O.H. formula), was used in the Petri plates. Rigid standardization of the viable bacterial content of the salivas was not possible, due to variations from day to day. In practice, it was found that once the volume of any individual's saliva required to give suitable plate counts had been established by experiment, day to day variations did not cause much trouble. On the other hand, the flora of different individuals showed obvious differences in sensitivity to the bactericides. It was made a rule that the person providing the saliva should wash the mouth thoroughly with tap water prior to collecting the saliva. Owing to the mucous nature of saliva we found it necessary to dilute with an equal volume of sterile water, as undiluted saliva did not readily pass through the "air brush".

Table 16 presents in summarized form the results of the more important tests on some salivas treated with mists of hexyl-resorcinol solutions and resorcinol solutions. If comparison is first made between "S²" (our standard aerial germicide) and "Aéryl", the superiority of the latter will be obvious, but this only applies in general terms to mist concentrations greater than $(400 \times 10^6)^{-1}$, whereas in the case of "S²", low concentrations, not rapidly lethal, were, nevertheless, capable of showing significant kills.

Table 16. *Mean percentage survivors of salivary flora treated with germicide mists over the hour periods (in terms of $(100 \times 10^6)^{-1}$ mists)*

Germicide mixture	Salivas					
	"A"	"B"	"C"	"D"	"E"	"F"
"S ² "	1.397	2.70	7.17	7.86	—	—
2S ²	1.15	1.09	2.36	3.37	1.05	1.88
S ² /N/50 NaOH	1.45	—	—	—	—	—
S ² /N/100 NaOH	0.50	—	—	—	—	—
2S ² /N/50 NaOH	0.78	—	—	—	—	—
2S ² /N/100 NaOH	1.47	—	—	—	—	—
"Aéryl"	0.97	1.72	2.64	1.11	1.07	—
"R.G.G." (45% resorcinol in 7% watery glycerol)	0.54	—	—	—	—	—

In an effort to overcome the lag period which hexyl-resorcinol solutions showed in the presence of saliva it was thought that the addition of traces of NaOH might facilitate the process of absorption by the bacteria. Caustic soda solution sufficient to make the concentration equivalent to N/100 was mixed with "S²", and the results were improved as shown in Table 16. Greater amounts (N/50) of NaOH apparently were not so efficacious, nor did doubling the strength of hexyl-resorcinol (2S²) sufficiently improve the kills to warrant the drawbacks as regards the increased cost and toxicity involved. Lack of space prevents our detailing here other mixtures devised to expedite

kills by hexyl-resorcinol. We may add that $N/100$ NaOH in water or glycol showed no "kill" in mists weaker than $(12 \times 10^6)^{-1}$.

Briefly, the addition of the following were tried either alone or in combination: sulphonated lorol, sodium-sulpho-ricinoleate, brilliant green, benzyl-cresol, and water and glycerol. A few such mixtures were as good as, but the majority were inferior, to what we designated $S^2/NaOH$, the composition of which is hexyl-resorcinol 10%, propylene-glycol 90%, sulphonated lorol 0.05%, NaOH to give $N/100$.

The important question of the particle size and persistence of germicide mist on bactericidal activity constituted our next line of enquiry. We have already gone far in this direction, and we shall now give the relevant experimental results and consider what bearing this might have on aerial disinfection.

Mist persistence and particle size in relation to germicidal activity

It is clear that any mist intended to kill bacteria in the air must be stable enough to allow time for the particles to contact the organisms; therefore the mist must be in a sufficiently finely divided state not to fall out like rain. Conversely, the mist must not be so fine as to evaporate before contact can take place, since small particles evaporate proportionately faster than large ones of the same kind. It is thus obvious that limits are imposed at both ends of the scale. According to Stokes's law, particles of 5μ radius fall approximately 3 mm./sec., i.e. roughly 1000 cm./hr., so that it is probable our mist particles should have a radius considerably less than 5μ . Subject to the limits imposed by rapidity of evaporation, it follows that the smaller the particles are, the more persistent will be the mist, and furthermore, the greater the Brownian movement, with consequent enhanced mobility.

In order to study the relative efficiency of particles over a range from 5μ radius downwards it was necessary to design an apparatus capable of producing such particles. Actually, two pieces of apparatus have been constructed, one which both produces and selects the mist, and the other a selector which can be attached to any type of mist producer. The selector in both instances is in effect a centrifugal device which, by variation in speed, air flow or in tube length, etc., of the centrifuge, extracts the large, unwanted particles. Calibration of the machines, by means of the ultra-microscope, has been carried out for us by Finn and Powell.

We have used saliva, *Str. agalactiae*, "F" coccus, *M. phlei* and *B. lactis aerogenes* as inocula for testing the lethal effectiveness of mists when the machines were set to give the "gross" output, when the particle sizes selected were >2 , 2, 1.3, and 1μ of $S^2/NaOH$, and "Aéryl". It should be pointed out that in using either selector apparatus, in the main, only those particles greater than the size specified are excluded. Thus, if the machine is set to cut-off at 2μ , the mist produced contains particles of 2μ and less, although not all the 2μ particles in the original mist as generated by the producer, the cut-off not being absolutely sharp.

The relationship between particle size and volatility is clearly demonstrated by the results given in Table 17, which compares "Aéryl" and S²/NaOH in constant mist concentrations of the various particle sizes. Finn & Powell showed that mists of resorcinol solutions evaporate very rapidly. A particle of "Aéryl" of 1.4 μ radius persists for about 500 sec. as compared with a 1.0 μ particle of S² which persists for at least 5000 sec. It must be pointed out that the criterion of persistence is limited by the resolving power of the ultra-microscope, and naturally, particles must persist as such for a time after they become invisible.

Consideration of the experimental results in Table 17 indicates that, relatively, the most economical particle size for hexyl-resorcinol solutions is probably at the most 1 μ, while the gross output of the machine appears to be required to obtain the best results with resorcinol on account of the volatility of the mist particles. It may be noticed that the results with S² and S²/NaOH at 1.3 μ, on the whole, are inferior to all the remainder; this we were able to assign to the irregularity of working of the machine. One of the difficulties we have had to overcome has been the adjustment of the machine to give dependable outputs. The same remarks apply to Table 18 where the results with S² versus *C. xerosis* and the "F" coccus are set out.

Table 17. *The effect of mist particle size of resorcinol and hexyl-resorcinol solutions on the survival rate of salivary organisms*

Germicide	Mist concentrations ($y \times 10^6$) ⁻¹ and particle size in μ							
	Gross output	2.0 μ	1.3 μ	1.0 μ	Gross output	2.0 μ	1.3 μ	1.0 μ
		<i>y</i> = 3200				<i>y</i> = 1600		
"Aéryl"	—	—	—	—	—	—	—	—
S ²	—	0.276	—	0.111	—	0.235	—	0.093
S ² /NaOH	1.4	0.434	—	—	0.94	0.508	NK	—
		<i>y</i> = 800				<i>y</i> = 400		
"Aéryl"	—	—	—	—	1.29	NK	—	—
S ²	0.75	0.475	5.25	0.111	1.15	1.10	1.35	1.6
S ² /NaOH	0.72	1.68	1.86	—	1.66	1.39	1.82	—
		<i>y</i> = 200				<i>y</i> = 100		
"Aéryl"	0.8	NK	—	—	0.04	16.0	—	—
S ²	1.5	1.5	3.4	0.185	1.7	1.22	—	—
S ² /NaOH	3.02	1.68	1.9	—	1.18	1.61	—	—

NK = No kill.

While the above results were merely indicative that 1 μ particles of hexyl-resorcinol might be the most efficacious of those tested, we felt fairly certain that ultimately we could prove this conclusively, and embarked on two fresh series of tests. In one series saliva "A" was used as inoculum against S²/NaOH mists produced by two supposedly reliable machines. One machine, EX 4 B, proved inconstant in its deliveries of mist, and the tests were repeated; a second machine, KB1, was found to be reliable. The results of these tests are given in Table 19. Another series of tests was carried out with machine

Table 18. *The effect of mist particle size of hexyl-resorcinol (S²) solution on the survival rate of C. xerosis and "F" coccus in broth emulsions*

Organism	Mist concentration ($y \times 10^6$) ⁻¹ and particle size							
	Gross output	2.0 μ	1.3 μ	1.0 μ	Gross output	2.0 μ	1.3 μ	1.0 μ
		$y = 3200$				$y = 1600$		
<i>C. xerosis</i>	0.52	0.075	0.26	0.072	1.25	0.97	0.55	0.084
"F" coccus	0.618	0.038	—	0.11	0.008	0.04	0.17	0.089
		$y = 800$				$y = 400$		
<i>C. xerosis</i>	1.21	0.978	0.38	0.220	0.44	0.632	0.16	0.22
"F" coccus	0.150	1.25	0.13	0.196	0.13	0.254	0.16	0.137
		$y = 200$				$y = 100$		
<i>C. xerosis</i>	0.53	1.742	0	0.33	0.13	0.476	—	—
"F" coccus	0.015	0.08	0.02	0.275	—	0.013	—	—
		$y = \text{mean}$						
<i>C. xerosis</i>	0.68	0.771	0.23	0.202				
"F" coccus	0.165	0.255	0.08	0.162				

KB1 generating mists in particle sizes of 2, 1 μ and the gross output, and with broth suspensions of *B. lactis aerogenes*, *Str. agalactiae*, *M. phlei* and with salivas "A" and "B". The results are shown in Table 20.

Table 19. *Comparison of the mean percentage survivors of salivary organisms treated with S²/NaOH mists in certain particle sizes*

Machine	Gross	> 2 μ	2 μ	1.3 μ	1.0 μ
EX 4 B (a)	0.980	1.858	1.861	0.253	0.177
EX 4 B (b)	3.351	1.080	0.508	0.141	0.113
KB1	0.709	—	1.156	0.382	0.177

Table 20. *Comparison of various organisms treated with S²/NaOH mists in certain particle sizes*

Organisms	Particle size		
	Gross	2 μ	1 μ
<i>B. lactis aerogenes</i>	1.270	0.686	0.203
<i>Str. agalactiae</i>	0.803	0.336	0.566
<i>M. phlei</i>	9.429	1.435	0.779
Saliva "A"	0.825	1.088	0.111
Saliva "B"	2.013	0.658	0.622

Tables 19 and 20 show fairly conclusively that mist particles of about 1 μ radius are more effective than those of larger size. A few of the results appear to be out of order, but most probably these can be assigned to variations in the resistance of the various organisms over the 6-weeks period required to carry out this number of tests.

For the purpose of testing the utility of particles of radii less than 1 μ the selector centrifuge was used in conjunction with an "Atmozon" nebulizer. By means of this combination we were able to perform the experiments with particles of 1, 0.5 and 0.25 μ radius of S²/NaOH, the test inocula being

Str. agalactiae and saliva "A". In Table 21 are given the percentage survivors of the test organisms when subjected to mists of the three particle sizes mentioned, compared with 1μ mists of $S^2/NaOH$ obtained from the machine KB1. The results expressed in terms of $(100 \times 10^6)^{-1}$ indicate that mist particles, at any rate down to 0.25μ radius acting on broth suspensions of *Str. agalactiae*, give increasingly better results as the particle size diminishes. We, at present, have not been able to test particles smaller than 0.25μ because of practical difficulties in obtaining adequate concentrations of such mists. As a matter of fact, only 3.5% of the total "Atmozon" output can be obtained as 0.25μ particles with our present apparatus (Figs. 45 and 46). There are indications from comparison of the figures for saliva "A" in the same table, that particles of S^2 less than 1μ may be too small to effect kills in the presence of saliva, although we are not prepared to be dogmatic on this point from the few results at present available.

Table 21. *Comparing the effect on Str. agalactiae and salivary organisms of $S^2/NaOH$ mists in particle sizes of 1μ and less*

Particle size		<i>Str. agalactiae</i>	Saliva "A"
KB1	1μ	0.566	0.111
A/S	1μ	1.594	4.291
A/S	0.5μ	0.744	2.836
A/S	0.25μ	0.487	3.091

Comparison of the results with KB1 and A/S (Atmozon-Selector) at 1μ is, perhaps, not quite fair in view of the lapse of time which occurred between the two series of tests; this again raising the question of variation in sensitivity of the test organisms. Another possible factor which may account for the discrepancies is that of differences in particle size distribution in mists produced by different means. In point of fact, the mean particle size of $S^2/NaOH$ mists from the "Atmozon" is 0.56μ , while that from the rotary type atomizer (EX 4D and KB1) is 0.86μ with the gross output and 0.65μ when the cut-off is at 1μ . Thus it can be seen that the mean particle size of the rotary type atomizers is considerably greater when cut at 1μ than that of the "Atmozon" gross output.

A further point of comparison of the relative merits of particle size has been arrived at by taking all the available test results (about 120) and calculating the survival rates in the presence of the graded mists in relation to that for the gross output, regarding the latter as 100. This mode of comparison is given in Table 22. In the two instances asterisked the gross output from the "Atmozon" was led through the stationary centrifuge, this possibly resulting in a slight loss of mist.

The role of the larger particles

From the economic viewpoint it seemed advisable to determine whether the larger particles were of any use, and the experiments just described were of value in this respect. The machine KB1 was run at constant times in each

Table 22. *Relative merits of the graded particles in terms of the survival rate for the gross mist (= 100)*

Germicide	Organism	Gross mist	> 2 μ	2 μ	1.3 μ	1.0 μ	0.5 μ	0.25 μ
S ²	<i>C. xerosis</i>	100	—	16	—	28	—	—
"	"F" coccus	100	—	31	—	98	—	—
"	"	100	—	91	—	—	—	—
"	Saliva "A"	100	—	74	—	16	—	—
S ² /NaOH	"	100	—	132	—	13	—	—
"	"	100	32	15	4	3	—	—
"	"	100	—	163	54	25	—	—
"	"	100	190	190	26	9	—	—
"	"	768*	—	—	—	249	165	180
"	Saliva "B"	100	—	33	—	31	—	—
"	"	100	—	23	—	6	—	—
"	<i>Str. agalactiae</i>	100	—	42	—	70	—	—
"	"	112*	—	—	—	92	48	31
"	<i>M. phlei</i>	100	—	15	—	8	—	—
"	<i>B. lactis aerogenes</i>	100	—	54	—	16	—	—
R.G.G.	Saliva "A"	100	—	679	—	—	—	—

series of tests whatever the cut-off of mist particles. This, naturally, varied the mist concentrations because with decreasing particle size the outputs decreased. We have tabulated the results against the times and particle size in Table 23. The figures represent the mean percentage figures to the first decimal place for each set of tests, and are not reduced to terms of $(100 \times 10^6)^{-1}$, the concentrations being shown at the end of the table.

When using the machine we had anticipated that, say, in 15 sec., it would deliver approximately the same number of particles of any given size below that at which the cut-off was set. This was proved to be not quite correct, and was due to the design of the centrifuge. It was found that with the centrifuge cutting off at say 2 μ , many 2 μ particles were retained, together with a considerable number of smaller ones, the relative number of small ones held back increasing as the smallest size cut-off was approached.

Some idea of this decreased output (by weight) in the case of machine KB 1 can be seen by the following figures:

$$\text{Gross output} = 100\%; \quad 2 \mu \text{ output} = 34\%; \quad 1 \mu \text{ output} = 5.4\%.$$

Although the figures were not quite up to expectations careful analysis shows that, relatively, the large particles do not function to the same extent as the small ones. We have taken all the experiments with saliva "A" and S²/NaOH which were done on the constant-time basis, and calculated the mean percentage survivors for each time group between 15 and 240 sec., for the gross output, 2 and 1 μ . In this way, taking the figures for the gross output as unity, the mean survivors can be expressed as 1 : 2.3 : 2.8 respectively over the whole range of times. The corresponding outputs by the machine are 1 : 0.34 : 0.054, and by multiplying these two expressions together we get 1 : 0.78 : 0.15. Thus in the experiments concerned the 1 μ particles appear to be, at least, between six and seven times more effective, concentration for concentration, than are the large particles, and more than five times more effective than are the 2 μ

Table 23. The mean percentage of survivors of certain organisms treated with S²/NaOH mists in certain sizes shown against constant time (of atomization)

Time in sec.	Particle size								
	<i>B. lactis aerogenes</i>			<i>Str. agalactiae</i>			<i>M. phlei</i>		
	Gross output	2 μ	1 μ	Gross output	2 μ	1 μ	Gross output	2 μ	1 μ
4	27.4	—	—	100	—	100	—	—	—
8	50.7	—	—	27.3	—	80.0	100	—	100
15	9.0	45.0	—	9.72	12.8	49.0	48	17.3	68
30	4.5	13.1	51.0	3.3	3.7	35.5	35	14.7	34
60	2.6	1.5	7.5	1.4	2.9	12.0	21	7.6	50
120	0.97	0.7	2.5	0.1	0.32	2.1	18.4	5.1	16
240	—	0.4	0.5	—	0.6	—	—	4.3	—
480	—	—	0.4	—	—	—	—	—	—

Time in sec.	Saliva "A"			Saliva "B"		
	Gross output	2 μ	1 μ	Gross output	2 μ	1 μ
4	—	—	—	—	—	—
8	4.0	—	—	8.8	—	100
15	8.2	28.2	12.8	12.2	—	100
30	2.7	26.0	7.7	16.5	13.5	60
60	3.7	4.9	4.6	6.2	5.0	23.7
120	0.9	2.6	20.0	2.0	4.5	12.8
240	0.5	1.3	1.8	1.3	2.3	—
480	—	—	—	—	1.5	—

Mist concentrations, 1 part per million part of air			
Time in sec.	Gross output	2 μ	1 μ
4	3460	—	—
8	1730	—	31,740
15	925	2600	16,940
30	462	1300	8,470
60	231	650	4,235
120	116	325	2,118
240	58	163	1,059
480	29	82	530

particles. Treated in the same way, the ratio for some non-salivary organisms was found to be 1 : 0.48 : 0.14, i.e. the 1 μ particles are apparently more than seven times as effective as the gross, and more than three times as effective as the 2 μ.

A second method of assessing the persistence of germicidal mists was that of producing in the test chamber mists in concentrations known to be lethal to the test organism, these mists being allowed to "age" for varying periods, up to 3 hr., before the bacterial mist was introduced. S²/NaOH and "Aéryl" have been tested in this way against saliva "A", "F" coccus or *Str. agalactiae*. The results are shown in Table 24, and compared in each series with a control test done on the same day with a "new" mist. So far as S² is concerned it will be seen that mists of particle size down to 1 μ are still capable of giving considerable kills even after 3 hr. "ageing". "Aéryl", on the contrary, does not show this persistence except in the gross-size particle, and then only in high concentrations. This point was further borne out by reference to the

kills at each period during tests. For example, in a $(50 \times 10^6)^{-1}$ mist of 2μ droplets of "Aéryl", 15 min. old, there was an initial kill, i.e. within 5 min., subsequent plates up to 1 hr. showing no percentage decrease in survival rate.

Table 24. *The mean percentage of survivors (in 60 min.) of salivary and two non-salivary organisms treated with "aged" mists of S²/NaOH and "Aéryl"*

Concentration of mist (10^6) ⁻¹	Age of mist min.	Particle size	Organism	Germicide	Mean percentage survivors
$(200 \times 10^6)^{-1}$	0	Gross output	Saliva "A"	S ² /NaOH	3
	30				6
	60				4
	90				14
$(340 \times 10^6)^{-1}$	0	2 μ	Saliva "A"	S ² /NaOH	9
	15				8
	30				12
	45				20
	60				38
$(600 \times 10^6)^{-1}$	0	1.3 μ	Saliva "A"	S ² /NaOH	9
	15				7
	30				10
	45				12
	60				20
$(527 \times 10^6)^{-1}$	0	1.0 μ	<i>Str. agalactiae</i>	S ² /NaOH	0.72
	15				0.24
	30				0.57
	45				0.24
	60				0.1
	90				1.75
	120				1.3
	180				7.4
$(57 \times 10^6)^{-1}$	0	Gross output	"F" coccus	"Aéryl"	5.0
	5				2.2
	10				4.0
	15				3.5
	20				2.9
	30				5.6
$(200 \times 10^6)^{-1}$	0	Gross output	Saliva "A"	"Aéryl"	2.8
	5				1.0
	10				0.6
	15				0.6
	20				1.2
	30				0.9
$(50 \times 10^6)^{-1}$	0	2 μ	Saliva "A"	"Aéryl"	37
	5				31
	10				73
	15				68
	30				58

Only a very few tests have been carried out to date on the persistence of mist particles smaller than 1μ radius, but we record these in Table 25 as indicative of what might be expected from their known physical behaviour. Because of different size distribution of the rotary and jet type atomizers we only give the tests done with 1μ particles produced by the latter as they form a truer basis of comparison. The table summarizes the experimental figures obtained with *Str. agalactiae* treated with 1, 0.5, and 0.25 μ mists. Broadly, the results show that the persistence of particles of S²/NaOH decreases with decrease in initial size.

Table 25. *The mean percentage survivors (in 60 min.) of Str. agalactiae treated with "aged" mists of S²/NaOH in particles of 1 μ and less*

Concentration of mist	Age of mist min.	Particle size	Mean percentage survivors
$(446 \times 10^6)^{-1}$	0	1.0 μ	4
	30		9
	60		21
	90		—
	120		40
	180		60
$(410 \times 10^6)^{-1}$	240	0.5 μ	60
	0		7
	30		10
	60		10
	90		—
	120		80
$(880 \times 10^6)^{-1}$	180	0.25 μ	100
	0		4
	30		3.3
	60		20
	90		28
	120		65

The above technique has, on occasions, been varied by atomizing after 30 min., second and third inocula of organisms into mists which were known to be lethal within 30 min. The following results are examples of the type of kill obtained with "Atmozon" gross mists of S² against the "F" coccus (Table 26).

Table 26

Mist concentration	Percentage of survivors			Inoculum	Age of germicide mist min.
	Minutes				
	5	15	30		
$(1910 \times 10^6)^{-1}$	0.3	0	0	1st	0
	11.7	6.6	0	2nd	33
$(1050 \times 10^6)^{-1}$	0.86	0	0	1st	0
	0.49	0.15	0	2nd	33
$(660 \times 10^6)^{-1}$	0.15	0	0	1st	0
	0.23	0	0	2nd	33
	0.4	0.23	0.06	3rd	66

Germicide "overhang"

Coupled with the question of mist persistence is that of germicide "overhang". By this term we refer to the enhancing effect, noted in our chamber experiments, in successive tests performed during the course of a day. Brief reference was made to this phenomenon earlier in this paper (p. 298), and we now propose to examine the matter more fully.

In the early days experiments in testing germicidal aerosols in the twin chambers were performed in decreasing order of concentration during a day's set of tests. Examination of the test results frequently showed that the last tests, i.e. those of lowest concentration, gave results as good, or nearly as good, as the first tests (the highest concentrations). Some tests carried out with phenol, specifically to demonstrate this effect, gave results as shown in Table 27.

Table 27

Mist concentration 1 part per million parts of air	Plate counts—min. after contact				
	1	2	5	15	30
(1) 0	∞	1760	2000	800	320
(2) 18.0	770	350	290	190	130
(3) 4.4	70	2	0	0	0
(4) 18.0	890	120	88	70	11
(5) 4.4	55	0	0	0	0
(6) 18.0	210	60	30	11	5

∞ = uncountable.

The tests were carried out in the order shown, with the "F" coccus, in heat-generated mists of phenol (p. 320), the lower concentration, known to be only slightly effective, being utilized alternately with the higher one, known to be lethal.

This "building up" or "overhang" is further exemplified in the persistence described earlier (p. 316). In a number of these tests the control, in which no ageing of the mist occurred, was the first test of the day, and we have made a list of these, and compared them with subsequent tests in the same series. Out of eighteen such cases the "aged" mist gave superior results on sixteen occasions, as can be seen from Table 28. While this additive effect is somewhat inconvenient in our laboratory tests it may prove to be a distinct advantage in practice where a constant mist concentration is required.

Table 28. *Showing the "building up" effect of mists in the persistence tests with S²/NaOH and "Aéryl"*

Germicide	Percentage survivors of organisms		Age min.
	Fresh mist	Aged mist	
S ²	8.9	7.36	15
	8.8	7.9	15
	0.85	0.24	15
	0.06	3.46	30
	0.17	0.13	30
	0.03	0.05	30
	18.53	(b) 13.51	90
	"Aéryl"	36.9	30.5
4.9		(c) 2.9	20
2.82		(d) 0.86	30

(b) = two tests intervening between "fresh" and "aged".

(c) = three tests intervening between "fresh" and "aged".

(d) = four tests intervening between "fresh" and "aged".

Germicidal mists produced by heat volatilization

Some of the phenolic substances referred to earlier in this paper have been utilized in mists produced by heat volatilization. In this way we were able to obtain a rough idea of the amount of pure substance required to saturate the air of a closed space (vapour), and consequently the minimum amount of

particulate mist required to obtain sterilization. In order to obtain sufficiently small quantities of the substances, solutions or dilutions were made in alcohol which latter, of course, evaporated before the boiling-point of the germicides was reached, and thus left a mist of pure substance.

The method of producing the germicide mists was a simple one, consisting of measuring the required volume of alcoholic solution into a thin metal capsule placed on an electric strip heater (350 W.). As soon as volatilization of the germicide had ceased (taken as the time when no more fumes rose from the capsule) the heater was withdrawn from the chamber to avoid heating the atmosphere unduly. The bacterial mists were introduced in the usual way, immediately after production of the germicide mist. The following substances have been tested in this manner: benzyl-cresol, amyl-meta-cresol, hexyl-resorcinol, phenol, propylene-glycol. Heat-produced mists of these substances when tested fell into the same order of germicidal activity as that shown by the atomization method.

Having assumed that we achieved saturation of the atmosphere of our chamber by the above method, and that where kills were obtained the active germicide was in the mist form, we attempted to arrive at the number of organisms which 1 ml. of the substance was capable of killing. The time factor was, of necessity, taken into consideration, and the criterion adopted was that sterility or practical sterility should be obtained with the minimum quantity of material within 15 min. Now the total number of organisms ("F" coccus) presented in each test was 360×10^4 , and it was found that the following approximate quantities were needed to fulfil the above requirements:

	ml.
Hexyl-resorcinol	0.0002
Benzyl-cresol	0.0004
Amyl-meta-cresol	0.01
Propylene-glycol	0.03
Phenol	0.04

When expressed as the number of organisms the germicides, in 1 ml. quantities, are capable of killing under the above experimental conditions we have:

Hexyl-resorcinol	2×10^{10}
Benzyl-cresol	1×10^{10}
Amyl-meta-cresol	4×10^8
Propylene-glycol	1×10^8
Phenol	1×10^8

Thus, according to this method of comparison, it would seem that the potency of the germicide in air bears little relationship to the Rideal-Walker coefficients; e.g. the Rideal-Walker of amyl-meta-cresol (250) is five times that of hexyl-resorcinol (50), yet the latter is 50 times more effective as a germicidal aerosol; and again, amyl-meta-cresol is 250 times more potent *in vitro* than phenol, yet only four times as active in the air.

The particle size of heat-produced mists

The particle size of heat-volatilized substances varies according to the following conditions:

- (a) the bulk of material at the source of heat,
- (b) air movements in the surrounding atmosphere,
- (c) the concentration of mist in a closed atmosphere, and
- (d) the age of the mist.

Finn & Powell have found that heat volatilization of a few crystals of hexyl-resorcinol produced mists containing many large particles, some of which were greater than 6μ radius. Mists produced from the residue of dilute alcoholic solutions, as in our biological experiments, contain some particles of 3.6μ , the average size of the large particles being 2.0μ . However, many particles of the order of $0.7-0.18\mu$ were present, and, numerically, formed the bulk of the mist. When the atmosphere was disturbed by a fan playing on the metal capsule the maximum size particle observed was 0.32μ radius, whilst the majority were of 0.18μ or less. Ageing of the mists tends to produce increases in particle size, due to coagulation of droplets, the mist just referred to having after 5 min. increased to 0.42μ , and after 7 min. to 0.46μ . It was observed that the number of particles decreased as the mist became coarser, the smallest particles apparently distilling over to, or colliding with, the larger ones, a number of sub-microscopic nuclei also being thought to be present as size increase is gradual, and no very large particles were seen (see p. 262).

The penetration of cotton fabrics by bacterial and germicide mists

For this group of experiments the test organism was the "F" coccus, the test germicide was hexyl-resorcinol and the test fabrics lawn, croydon cloth and longcloth. The bacterial mists were generated with an "Aerograph" brush, and the germicide mists by heat volatilization. A wire frame approximately $12 \times 12 \times 6$ in. was dressed with the test cloth, and placed in a sealed chamber, the cage being about one-twenty-eighth the capacity of the latter. The test mists were, as a rule, generated outside the cage, and penetration of the cloth under examination tested by placing suitable indicators inside. The presence of bacteria was demonstrated culturally while the presence of germicide was demonstrated chemically (colorimetrically) or by lethal effect on bacteria.

The rate at which the bacterial mist diffused through the test cloths was first determined. It is necessary to point out that longcloth is slightly coarser than linen, although of a finer "grain" than the relatively heavy croydon cloth. The lawn was naturally expected to be easily the most permeable, our experimental results conforming to expectations. The approximate percentage of cocci having penetrated the cloths in 1 hr. was found to be: lawn 25, croydon cloth 10, longcloth 5. Sometimes as many as 20% had diffused through the lawn within 15 min., but thereafter diffusion seemed to be slow, and an equilibrium between inside and outside of the cage was not reached in any of our experiments.

The rate of diffusion of the germicide mist was first tested colorimetrically,

as a spot test carried out on a white, glazed, porcelain tile. The tile, after being exposed to the germicide mist, was treated with one drop of *N/50* sodium hydroxide and one drop of paranitraniline. In control tests for sensitivity it was found that a full reaction was given by exposure of the tile for 1 hr. to a mist concentration of 1 part in 1780×10^6 of air, but only a slight colour reaction was obtained with half this concentration. With this technique for estimating the germicide it was found that inside the lawn cage the strength of mist in 1 hr. was 75% of that outside where it had been generated. No comparative figures are available for the other two test cloths, but, nevertheless, so far as we have examined the question it appears that interference with diffusion of the germicide mist by longcloth and croydon cloth is relatively less than the interference with diffusion of the bacterial mist, i.e. compared with what was found with the lawn. This may be accounted for by the finer particle size of the germicide mist and the passage of germicide as vapour.

Detection of the germicide by means of its lethal effect on bacteria was attempted under different conditions—bacterial mists in the air, seeded on cotton thread, agar culture plates and dry plates. The concentration of germicide mist in the air necessary to give evidence of a kill according to the experimental conditions was, of course, determined previously, the experiments entailed having been discussed elsewhere in this paper.

It was found that in order to demonstrate the passage of a heat-generated germicide mist through the cloths it was necessary to deal with a fairly high concentration. In a concentration of $(130 \times 10^6)^{-1}$ an amount of germicide sufficient to kill 98% of an atomized broth emulsion of the "F" coccus diffused through the cloths in 1 hr. Concentrations had, of course, to be higher in order to effect a kill under the more exacting experimental conditions of seeded plates, threads, etc.

In one type of experiment plates of culture medium were utilized as "test individuals", they being placed inside the cloth cage in the presence of a germicide mist. In all experiments there was some contamination of the plates by the "F" coccus generated as a mist outside the cage, but the experimental conditions were severe, as the distance the bacteria had to travel in the presence of the germicide before reaching the plates was not more than 6 in.

The main point in the whole of this group of experiments is that germicide mists have been shown to be capable of penetrating cloth barriers and exerting their specific action on bacteria. Further, when the air within the cloth chamber was continuously contaminated by percolation of bacteria from without, the germicide mist continued to deplete the air of the invading bacteria for a considerable period of time, i.e. until it had mostly changed into the vapour state.

The sterilization of surfaces

It was of some importance, when utilizing a germicidal aerosol for air disinfection, to ascertain what was happening to bacteria which might be lodged on the walls or floor or on room furnishings, etc. The three main

materials which served as test surfaces were cotton threads, microscope slide cover-slips and Petri dishes of agar medium, the "F" coccus again being used as test organism. The cover-slips were found to be most useful for determining the difference as regards ease of sterilizing of horizontal and vertical surfaces. A typical series of results with cover-slips contaminated with the "F" coccus and subsequently treated with heat-generated hexyl-resorcinol mist is given below, cultivation of the coccus from the slips being carried out on agar plates.

Table 29

Mist concentration 1 part per million of air	Minutes of contact	Cover-slips (plate counts)		
		Controls	Horizontal	Vertical
3.6	30	∞	0	∞
7.2	30	∞	0	112
17.8	30	∞	0	180
35.6	30	∞	0	∞
71.2	30	21	2	∞
178.0	30	∞	0	∞
356.0	30	17	0	∞
71.2	60	∞	—	5
178.0	60	∞	0	3
356.0	60	∞	0	—

∞ = confluent, uncountable growth.

Parallel experiments wherein the "F" coccus was replaced by saliva "A" showed that the mist had to be more concentrated to obtain equally satisfactory kills. It thus appears that sterilization of a polished floor by means of our germicide mist would probably be a practical proposition as far as pathogens are concerned, but sterilization of walls under similar conditions would be a much more difficult, although less important, problem.

A similar series of experiments was carried out with our coccus and saliva in which heat-generated resorcinol was substituted for hexyl-resorcinol. From the results it appeared that the former compared favourably with the latter, the relative effectiveness of the two germicides following more closely their effectiveness when bacteria are suspended in the air than when they are suspended in watery fluids.

For obtaining information as to the ability of our germicide to affect bacteria settled on moist surfaces we selected sterile plates of agar. The plates, seeded with a mist of the coccus, failed to show development of colonies on incubation when they had been exposed to a concentrated mist of the germicide for a short time. Further tests in this direction are required as we did not obtain an end-point, and the same may be said of tests with moist and dry cotton threads contaminated with mists of bacteria, and subsequently exposed to germicide mists.

3. TOLERANCE TESTS

BY C. C. TWORT

In the final choice of germicide to be used for the particular purpose in hand, the prime consideration is the host-parasite tolerance ratio. Unless this is in favour of the host, the germicide should not be used, however near the ideal its remaining characteristics may be. The ratio will, of course, vary from parasite to parasite and from individual to individual, especially as regards the former, hence the uses of any particular germicide may be limited.

Tolerance tests of the germicides and solvents in which we were interested have been performed on man, animals (mice) and bacteria. The tests on man were concerned only with detection by the special senses; those on mice by the lethal effectiveness, and capability of producing acute symptoms on injection, and chronic symptoms by mixing the germicide with the diet over a long period; and those on bacteria by determining the bactericidal and bacteriostatic dose in the air, etc.

HUMAN TOLERANCE

The ideal germicidal aerosol should be absolutely undetectable by those who may find themselves in its presence. This is particularly of importance from the psychological point of view, although it is granted that under some circumstances a slight odour of disinfectant may have psychologically a beneficial effect. We adopt the simple procedure of atomizing into a room of known dimensions a given quantity of the mixture under test, the particles of which mist are known to be within certain limits as regards size. A number of individuals then passes through the room and each records any impressions elicited by the presence of the mist. We only consider worthy of study those mixtures which cannot be detected by the average man at a concentration many times above that in which they show definite lethal effects on bacteria in the air. The two germicides designated "S²" and "Aéryl", practically fulfil these conditions, but others, such as benzyl-cresol, although very powerful aerial disinfectants, are irritating to the mucous membranes, and could not be used continuously in the presence of man. As a matter of fact, the presence of "S²" in not very high concentrations is detected by most individuals by what is described as a faint, musty odour¹, likened, sometimes, to the odour of a barn. Under similar conditions the presence of a mist of "Aéryl" cannot, as a rule, be detected by its odour.

ANIMAL TOLERANCE. THE PRODUCTION OF ACUTE SYMPTOMS

The acute toxicity of a germicide is determined by the intraperitoneal injection of varying quantities into male white mice. The lethal dose is not calculated per unit (kg.) of animal tissue, for such a procedure introduces quite a considerable error unless the precaution is taken to utilize animals of

¹ Very fine particles of odourless substances may give rise to what is often described as a dusty odour. *Trans. Farad. Soc.*, 1936, pp. 1098-9.

almost exactly similar body weight, a condition not always easy of attainment where a relatively small stock of animals is maintained.

Our titrations are based upon a body weight of 20 g., and where the weight deviates from this the dose is calculated from the square of the cube root of the body weight. Thus, if the average individual minimal lethal dose of a germicide for a 30 g. animal was 1 mg., about half this amount would be lethal for the average 10 g. animal, but almost certainly not lethal for the 15 g. animal. We have performed thousands of intraperitoneal injections of substances other than germicides for titration purposes, and by calculating on this basis have never been able to convince ourselves that the lethal or symptomatic effect of the substance under test more often became manifest in the high- than in the low-weight animal. When the intraperitoneal channel of administration is chosen, the relative toxicity for different kinds of animals, such as rats and mice, is best compared by calculating as above.

The approximate lethal doses of the pure substances for the average animal of some germicides tested are given in Table 30, and of some solvents in Table 31.

Table 30. *Average individual lethal dose*

(Intraperitoneal injection of 20 g. mouse)

Substance	No. of animals	Lethal dose in c.c.
Para-chlor-meta-cresol and xyleneol	17	0.016 O
Tertiary butyl- and octyl-phenol	15	0.008 O
Benzyl-cresol and "Cresantol 3"	40	0.008 M
		0.020 O
Thymol	7	0.006 M
Salol	76	0.013 M
Mixtures of salol and thymol	64	0.010 O
		0.012 M
Amyl-meta-cresol	15	0.020 M
		0.030 O
"C.B.P."	10	0.008 M
		0.020 O
Resorcinol	15	0.005 W
		0.006 O
"Aéryl"	8	0.010 W
Hexyl-resorcinol	8	0.004 O
"S ² "	5	0.100 W

Note. M=diluted in mineral oil; O=diluted in olive oil; W=diluted in water. "Aéryl" contains approximately 45% of resorcinol in watery glycerine. "S²" contains 10% of hexyl-resorcinol in propylene-glycol.

Table 31

Substance	No. of animals	Lethal dose in c.c.
Ethylene, diethylene and propylene-glycol; carbital and cellosolve	36	>0.050 W
Terpineol	10	0.004 M
Benzyl alcohol	15	0.005 M
		0.010 O
Benzyl-benzoate	5	0.025 M
Cyclohexanol	16	<0.050 M
		0.030 O

But few animals were utilized for these tests, as only very approximate figures were required. On the whole the oil-soluble germicides appear to be less toxic when dissolved in olive oil than when dissolved in "white" mineral oil. It will be noted that the minimal amount of both resorcinol and hexyl-

resorcinol sufficient to cause death is approximately the same, but in assessing the acute toxicity of a substance it is not only the lethal dose which has to be taken into account; the presence of symptoms when a non-lethal dose is injected being also a matter of importance.

As a rule, symptoms of intoxication of mice with phenolic substances come on almost immediately ($\frac{1}{2}$ –5 min.) after injection into the peritoneal cavity, the animal making a complete recovery within an hour or so from a sublethal dose. Salol is one of the exceptions, partly, it may be, on account of its lack of solubility. Here symptoms do not become manifest for at least 2 hr., and once having supervened, death is invariable. The onset of symptoms consists of sudden attacks of tetanic spasms lasting for about $\frac{1}{2}$ min. with intervals of relief of only a few minutes. The third or fourth attack is usually fatal. In the case of thymol, terpineol, etc., the symptoms are more of the nature of narcosis, the animal, after a preliminary stage of excitement, sinking into coma. The breathing is slow and spasmodic, recovery, in favourable cases, being gradual.

The rapidity with which the bulk of the phenolic germicides is removed from the oil solvent, presumably by the endothelial lining of the peritoneal cavity, is remarkable, even when the oil is mineral in origin. The rapidity of removal would appear to surpass that of the removal of simple hydrocarbons (Twort, Lyth & Twort, 1936) and quite naturally that of bacteria (Twort, 1913). The amount of the chemical substance under test remaining free in the cavity is determined by consideration of the refractive index of the recovered inoculum, the amount which has been removed or has undergone chemical change being found from the difference in the indices of the inoculum before and after injection. The technique used and the general features associated with the test as applied to hydrocarbons, etc., has been described elsewhere (Twort & Lyth, 1935).

As might be expected it was easy to demonstrate the relatively slow absorbability of salol as compared, for example, with thymol. Nevertheless, the bulk of the salol was apparently absorbed some time before the onset of symptoms of poisoning, possibly due in part to the removal being in the first place more as precipitated particles than as molecules, salol having a tendency to come out of solution in the concentration in mineral oil used by us as inoculum.

From Table 30 we see that the ratio of the lethal dose of "Aéryl" to that of "S²" is given as 1 : 10, but what is not shown in the table is that the ratio of the symptomatic dose was 1 : 50 or 100, a very important difference in favour of the latter. The symptoms of intoxication with "Aéryl" are those of acute irritation, and are extremely distressing and violent; although when they are the result of a sublethal dose, complete recovery may quickly take place (perhaps within 1 hr.). This product contains, besides resorcinol, a little glycerine, and 0.005% or thereabouts of an aniline dye, probably brilliant or malachite green. The symptoms referred to may thus not have been entirely due to resorcinol, but it did not seem worth while to pursue this point further.

THE PRODUCTION OF CHRONIC SYMPTOMS

These tests were performed by adding the germicide to the food or water on the one hand, or by exposing animals to the vapours or mists on the other. Possible direct effects on the skin were investigated by application of the substance to the backs of mice over a long period of time. In all standard tests of a substance two hundred animals, comprising an equal number of each sex, were divided into two lots, one serving for the test proper and the other as controls. Care was taken, in the absence of individuals of a pure strain, to have, as far as possible, equality of colour of coat, body weight, etc., in both groups of animals. The usual practice was to perform a tentative test with a single box of ten animals, from the results of which a decision was reached as to the advisability or not of carrying out a more elaborate test.

The general procedure was to keep an accurate record of body weight of living animals, and of survival rate. A post-mortem examination was made of selected animals which died spontaneously and of all animals which were killed. The microscopic appearance of the organs was noted and an examination made for helminths, the body weight, weight of kidneys, brain, spleen and pituitary gland being recorded. The general technique used in performing these different operations has been described elsewhere (Twort & Twort, 1932), and it will suffice perhaps if it is mentioned here that in the case of the pituitary the organ was removed *in situ* with the base of the skull, dehydrated with alcohol, dissected, and weighed on a microbalance, the other organs being weighed on a torsion balance. The organs mentioned, together with the suprarenal, liver, thyroid, parathyroid, lung and any others thought likely to show interesting features, were, as a routine, examined microscopically, special attention being given to the presence of protozoal parasites such as *Klossiella muris*, *Haplosporidia* and *Sarcocystis* (usual incidence—see Twort & Twort, 1932). In the skin application experiments the skin itself was, of course, examined, while in other cases it was the bladder or the stomach which received special attention.

Tentative tests with a variety of germicides and solvents administered in different ways were carried out, but most of them failed to give results of a positive nature sufficient to warrant the undertaking of the more elaborate test. In each case a single box of ten animals, with a further box as controls, was used. Some of the tentative experiments with mice, of which some have not yet reached completion, consisted in

- (a) Painting over the interscapular region with "S²", daily, for 40 weeks.
- (b) Exposing to the vapours of benzyl-cresol for 10 weeks.
- (c) Exposing to atomized ethylene-glycol for 3 weeks, the commencing concentration being 1/64,000 which was doubled each day for 5 days until it reached 1/2000 of air, at which level it remained until the termination of the experiment.
- (d) Adding 1% benzyl-alcohol to the drinking water for 40 weeks, etc.

So far, in none of these experiments were the animals, to all appearances, affected to the slightest degree, although in the case of the atomized ethylene-glycol the atmosphere was literally dripping with the test substance. Tentative tests with two glycols, to be mentioned later (p. 329), gave definite positive results, and were followed by further tests involving the use of a larger number of animals.

The substances selected for the standard test and the type of test performed were:

Thymol	Drinking water.
Thymol-salol mixture	Skin painting.
Hexyl-resorcinol—propylene-glycol mixture	Feeding.
Propylene-glycol	Feeding.
Propylene-glycol	Drinking water.
Ethylene-glycol	Drinking water.
"Aéryl"	Drinking water.

Some of these experiments have also not yet reached completion, but it is safe to say that none of the substances tested, administered in small doses, leads to gross pathological lesions in mice, even when given over half the life span of the animal. For instance, the substitution of a saturated watery solution of thymol (about 1/1000) for ordinary water during 65 weeks seemed to have no detrimental effect on the survival rate (forty-eight test and thirty-four control animals alive), nor on the general health of the animals concerned, gauged by body weight and microscopical appearances of the internal organs. Further, there was no evidence that the thymol influenced in the slightest the incidence of protozoal parasites in the organs, or the severity of the infection when present. Again, the application of a small amount of an eutectic mixture of thymol and salol to the skin of the mice, five times per week for 60 weeks, although it produced a little dermatitis, including a definite degree of hyperplasia of the epithelium, induced nothing in the nature of a tumour and has apparently no effect on the general health of the animals.

In the hexyl-resorcinol feeding experiment each box of ten animals was given each day 1 g. of a mixture of hexyl-resorcinol 10, propylene-glycol 40 and "Oxo" 50% for 4 weeks and, subsequently, 0.1 g. during the remainder of the experiment. The controls received, instead, a 50/50 mixture of propylene-glycol and "Oxo". At the thirtieth week of the experiment there were fifty-nine of the experimental animals and forty-eight of the controls alive. It is concluded that, at the dose given, hexyl-resorcinol is harmless to mice, and nothing has been observed in the examination of the organs of the animals which have died to nullify this conclusion.

The experiments on toxicity of importance from our point of view were those with the solvents, and not those with the germicides themselves. The fact that hexyl-resorcinol has to be diluted with many times its weight of solvent in order to obtain the maximum benefit from its use, in the case of

"S²" there being one part of the former in nine parts of propylene-glycol, made it imperative to show that no danger was to be expected from the glycol before its use in a germicidal aerosol mixture could justifiably be advocated.

As mentioned previously, tentative experiments were carried out with 1 and 2% of both ethylene- and propylene-glycol added to the drinking water of four boxes of ten animals in each. In the case of the 1% solutions seven of the ethylene- and one (probably chance) of the propylene-treated animals died within a short time, the remainder being killed. All the animals watered with the 2% solution of propylene were alive and apparently healthy after having no other fluid for 10 months. In the case of the ethylene group, eight animals died within 2 months, one survived for 5 months, while one is still alive and apparently in quite good health. This particular animal, which like its companions was a male, must have been constitutionally (or perhaps anatomically) exceptional to have resisted the toxic effects of the ethylene-glycol, judging from the results of the standard experiments.

In the first series of standard experiments three hundred animals were divided into three groups each of fifty males and fifty females, of similar weight, colour, etc., the first group being watered with 0.5% ethylene-glycol, the second with 2% propylene-glycol, and the third with ordinary tap water. After 10 weeks the amount of the glycols was doubled, at the fifteenth week redoubled and at the twentieth redoubled again. The total amount of glycol consumed during the course of the experiments, a matter of 25 weeks, was: ethylene 253 c.c., propylene 1784 c.c., the very approximate consumption per animal per day (in c.c.) being:

	Weeks			
	1-10	11-15	16-20	21-22
Ethylene	0.011	0.018	0.041	0.070
Propylene	0.044	0.096	0.143	—

It will be noted that the percentage of glycol in the drinking water had apparently little influence on the total quantity of fluid consumed (p. 334). Although no attempt was made in this series of experiments to check the amount of plain water drunk by the controls, the frequency of filling of the drinking bulbs roughly corresponded to that required for the glycol animals.

Details as to the survival rate in the different groups of glycol animals are illustrated in Figs. 50-53. Spontaneous deaths are shown only up to the twenty-first week, as after this date some of the animals were killed in order to obtain at least a few good microscopical specimens. Up to the end of the twentieth week, the survival rates compare well with those of the controls (forty-four males and forty-nine females), with the exception of the ethylene-glycol male group wherein the death-rate was high. Subsequently, the increased dose of the test substance consumed caused collapse of the members of the remaining three groups also.

The animals at the commencement of the experiments were not fully grown so that there was a tendency for the body weight to increase gradually as the

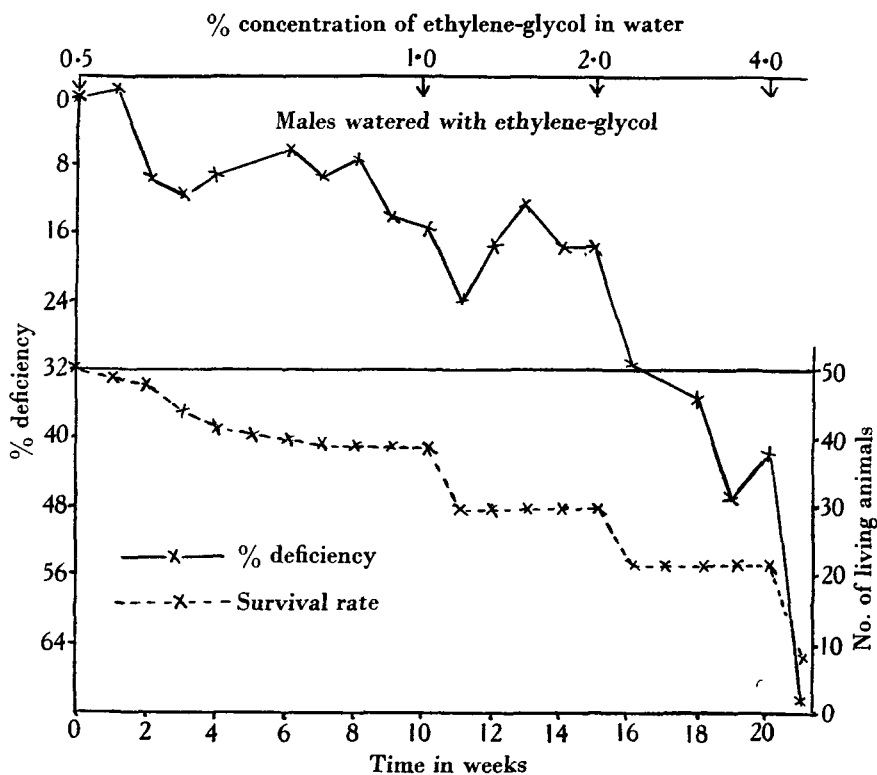

Fig. 50. Toxicity of ethylene-glycol—males.

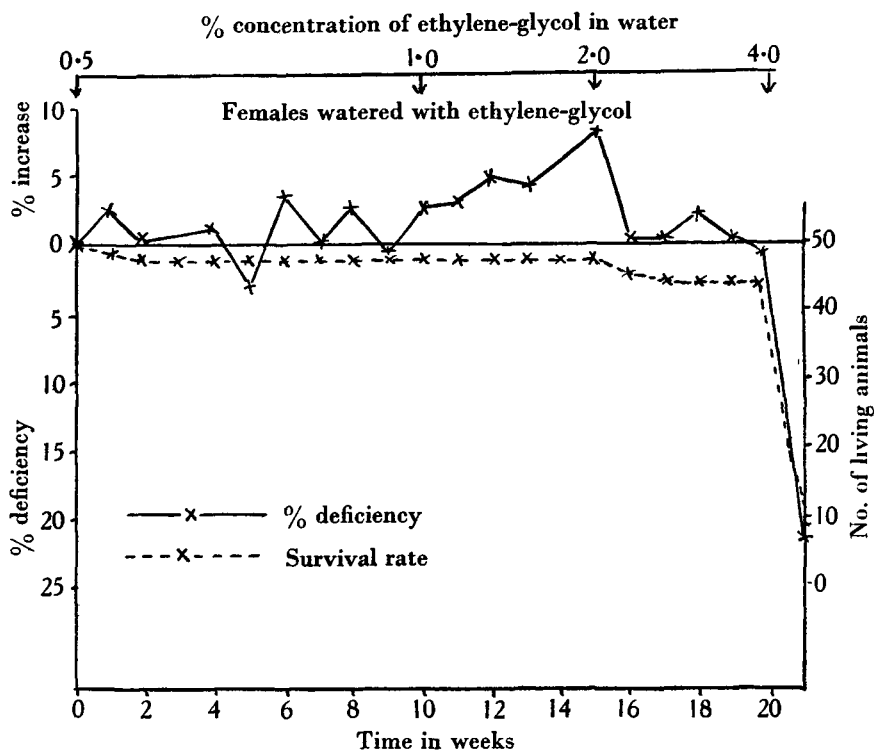

Fig. 51. Toxicity of ethylene-glycol—females.

experiment progressed. Any failure to increase is depicted in the graphs as a percentage deficiency compared with the controls. Thus, where in a given time a control animal of 20 g. increased in weight to 30 g., and a 20 g. animal

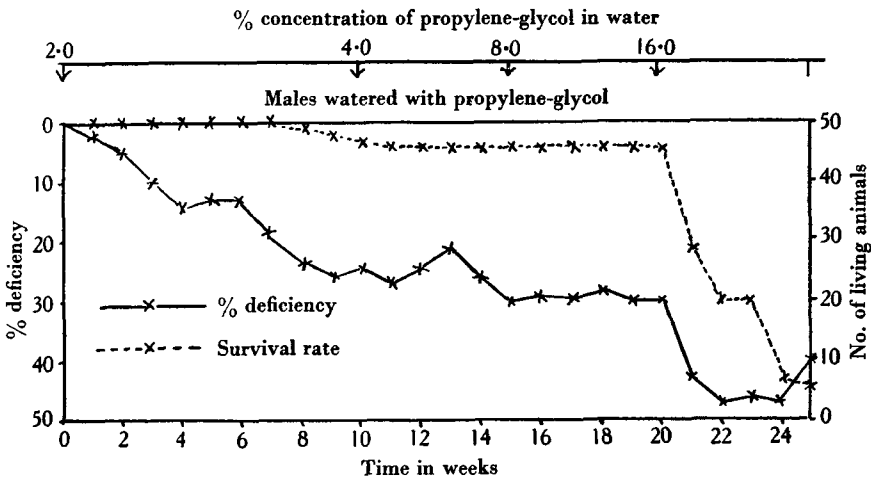

Fig. 52. Toxicity of propylene-glycol—males.

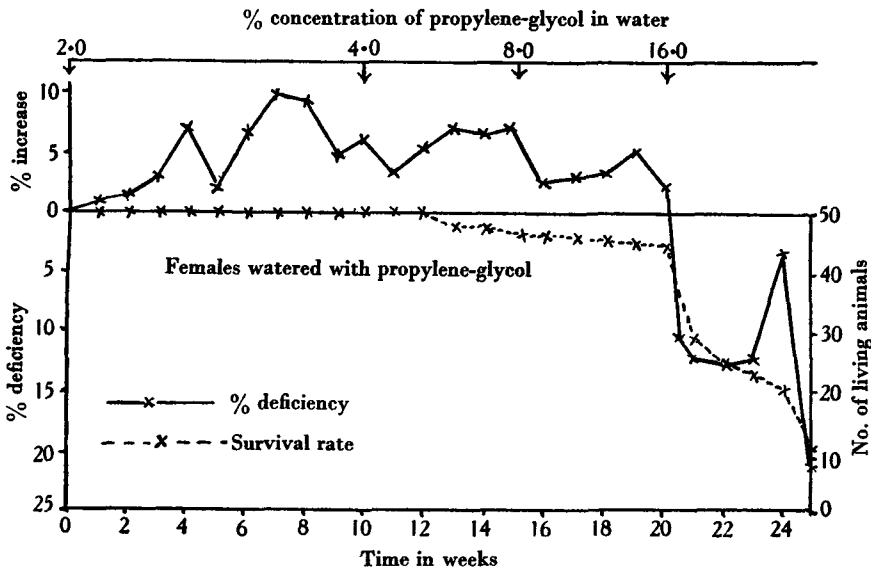

Fig. 53. Toxicity of propylene-glycol—females.

watered with glycol only reached 25 g., the percentage difference in increase is 25, equal to a 50% deficiency.

The results of this series of experiments confirm the findings in the tentative tests already referred to (p. 329) as to the greater lethal effectiveness

of ethylene-glycol compared with propylene-glycol. It is well to emphasize that in studying the graphs due consideration must be given to the fact that the animals received four times the quantity of propylene as they did of ethylene-glycol, but, even so, the survival rate was much the poorer in the latter group. A remarkable feature, however, is the apparent great difference in sex sensitivity to both glycols. This is seen among the ethylene animals both as regards poor survival and body-weight deficiency, but among the propylene animals only as regards the latter. It should be pointed out here, however, that at the commencement of the experiment, the body weight of the propylene-treated animals was on an average definitely higher than that of the controls. Among the females neither glycol appeared to be causing any ill effects until a concentration of 4% ethylene and 16% propylene had been reached, but then the effect on all groups of animals was deadly.

From the post-mortem examinations the only findings of interest definitely related to the effect of the glycols were in connexion with the urinary tract. Even here, owing to the high incidence of protozoal nephritis causing gross pathological lesions among all groups of animals, only special features could be considered. There are two points to which reference may be made: (1) distension of the urinary bladder, and (2) swelling of the kidneys. The former condition was found at death with apparently abnormal frequency among male animals intoxicated with ethylene-glycol. In one instance eight of nine such animals which died on a single day had fully distended bladders, and in another instance four out of six were in a similar condition. We are, however, doubtful whether these findings are significant, as in subsequent post-mortems the condition was observed much less frequently. The presence of albumen was demonstrated in all the urines tested, but owing to the high incidence of protozoal infections no significance can be attached to this finding.

Enlargement of the kidneys was estimated by measurement of mesial sections and weight comparisons with the findings in controls. There was little to choose between the two procedures, one set of figures correlating well with the other. The percentage number of times the kidney of the killed glycol animal was superior in weight to that of a control of corresponding body weight was:

	Ethylene-glycol	Propylene-glycol
Females	80	37
Males	86	87

It may be mentioned here that intercorrelation values of the body, kidney, spleen, brain and pituitary gland weights are, as a routine, calculated. Even by the relatively inaccurate ranking method sometimes useful information is gained, especially by a detailed study of animals providing organs which are a bad "fit". Meanwhile, however, we have deduced little of interest from a study of the data collected from any of our animal experiments connected with aerial disinfection.

Although it may be considered that we have in the main confirmed the

findings of previous workers, as to the greater toxicity of the ethylene- than the propylene-glycol, during life it is only as regards the male animal that this is so. During life we had no evidence among our animals that the female reacted differently to one or the other glycols. To sum up, the features indicative of the presence or absence of intoxication in our four groups of animals are shown in Table 32.

Table 32

	Ethylene		Propylene	
	M.	F.	M.	F.
Poor survival rate	+	-	-	-
Body-weight deficiency	+	-	? +	-
Hydronephrosis	+	+	+	-
Distension of bladder	? +	-	-	-

N.B. Ratio of dosage: ethylene/propylene 1 : 4.

M. = males. F. = females. + = present. - = absent.

A second series of experiments with drinking water has been included, mainly with the object of verifying the deficiency in body weight found previously among the propylene-glycol males. There was a possible fallacy due to the original weights of the propylene males being somewhat higher than that of the controls, and for this allowance has to be made in estimating the significance of any percentage deficiency of rise. In the second series there were one hundred animals watered with "Aéryl". Here the amount of material added to the drinking water was the same for each substance, the commencing dose being 0.1%, the percentage increase each week being so adjusted that, at the end of the twenty-fifth week, the animals surviving should have consumed an amount of the glycols and the "Aéryl" exactly similar to that consumed by the ethylene-glycol survivors in the first experiment. The second experiment has now been in progress for 20 weeks, the drinking water at the moment containing 3% of the substance under test. The number of survivors and the percentage body-weight deficiency are given in Table 33.

Table 33

	Ethylene-glycol		Propylene-glycol		"Aéryl"		Controls	
	M.	F.	M.	F.	M.	F.	M.	F.
Survival rate	6	35	44	48	43	43	41	45
% body-weight deficiency	-18.2	+9.2	+10.4	+6	-8.2	-10.4	0	0

It will be seen that especially among the ethylene-glycol males, and to a less extent among the females (when the concentration of glycol was above 2.5%), there is evidence of intoxication sufficient to lead to a fatal issue. It remains to be seen whether eventually, as the dose of drug consumed is increased, the weight of the propylene-glycol males lags behind that of the controls. The weight lag of the "Aéryl" animals is, of course, not unexpected in view of the amount of resorcinol entering into the composition of this germicide.

A feature which has been more carefully studied in the second series of experiments is that of mean fluid intake per week per living animal (Fig. 54). When on a diet of crushed oats and chopped hay a mouse will drink the equivalent of, or more than its body weight of water in a week during summer, and more than half this amount in winter when maintained in slight artificial heat. It was found that during the first week of the experiment, when the amount of test substance added to the water was only 0.1%, the fluid intake was, more or less, equal among all animals, but soon the intake of "Aéryl" water by the average animal was only 83% of that of the average control

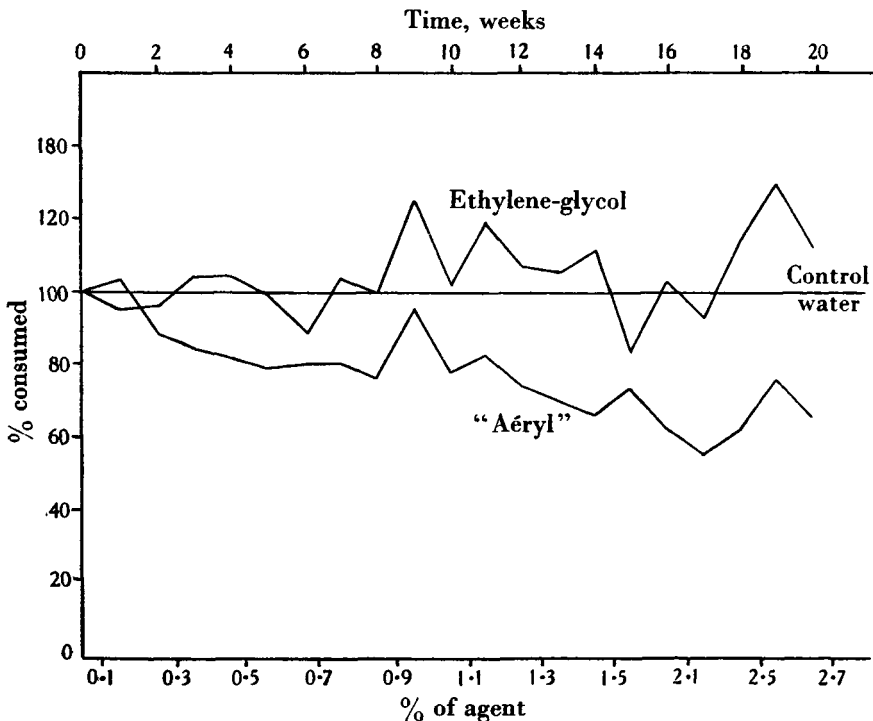

Fig. 54. Fluid intake of ethylene-glycol and "Aéryl".

receiving ordinary tap water. The intake then remained at a level of 75–80% for the next 7 weeks, but has now fallen (twenty-fifth week) to 32%.

The intake of the average propylene-glycol animal has deviated very little from that of the controls, but that of the ethylene group showed a definite tendency to increase as the concentration of glycol became higher. At the twentieth week, however, the intake is only 113% of that of the controls, the smallness of the difference possibly being due to the relatively high death-rate among the male animals. During the first 5 weeks the consumption of ethylene was consistently less than the consumption of propylene-glycol, then things were reversed and have remained so each week, with one or two exceptions. We have observed incidentally that the male animals tend to consume more

of both glycol waters than do the corresponding females, over and above body-weight difference, but we have not checked the actual consumption in each subgroup.

BACTERIUM TOLERANCE

Some idea of the lethal dose of the germicide for the average individual bacterium was required, in order to obtain information as to the host-parasite toxicity ratio. In the first place, the organisms were classified in order of resistance to phenolic bodies. We shall proceed to describe briefly the technique employed, together with that used for determining the minimal lethal dose per organism, the resistance tests furnishing data on which the latter tests were based. We are indebted to Mr C. L. Hunter for having carried out the majority of the tests about to be described.

Chick & Martin (1908) found that disinfection is a function of concentration, time and temperature, so that we cannot state a minimal lethal dose without qualifications in these respects. For our tests we decided to fix the time and temperature as constant, i.e. kills to be obtained in $2\frac{1}{2}$ min. at 18° C. (room temperature), with concentration as the only variant.

Because, at the time the resistance tests were being done, we were using germicide DX for air-sterilization experiments, the chief constituent of DX, viz. thymol, was used for resistance tests. Later benzyl-cresol, hexyl-resorcinol and phenol were tested. Dilutions of thymol in water ranging from 1/1400 to 1/3600 were used in 6 ml. amounts, and 0.1 ml. of the bacterial suspensions (standardized by Brown's opacity tubes to 750×10^6 per ml.) was added to each. After intimate mixing and being allowed to stand for $2\frac{1}{2}$ min., 1.0 ml. was removed from each tube into 99 ml. of sterile water. Platings of 1.0 ml. of this dilution were made in agar, and results recorded after 48 hr. incubation at 37° C. We have arranged the list in Table 34 in descending order of resistance, showing also the highest dilution of thymol which gave complete sterility in $2\frac{1}{2}$ min.

Table 34. *Twenty-five organisms classified in order of resistance to thymol water*

Strength of thymol	Organisms
1 1/1400	<i>B. lact. aerogenes</i> , <i>M. leprae</i> , <i>M. stercusis</i>
2 1/1600	<i>Br. abortus</i> , <i>B. lactis viscosus</i>
3 1/1800	<i>Nocard lutea</i> , <i>M. smegmatis</i>
4 1/2000	<i>S. aureus</i> , butter bacillus (Rabinowitz)
5 1/2200	<i>S. pullorum</i> , <i>Str. mucosus</i> , <i>Str. pyogenes</i> , <i>Str. agalactiae</i> , <i>B. prodigiosus</i>
6 1/2400	<i>B. friedländer</i> , <i>Str. faecalis</i> , "F" coccus. <i>B. laterisporus</i>
7 1/2600	<i>E. coli</i> , <i>B. murisepticus</i>
8 1/2800	<i>C. hofmanni</i>
9 1/3000	<i>C. xerosis</i> , <i>B. caratovra</i>
10 1/3200	<i>P. avisepticus</i> , <i>C. diphtheriae</i> (Park 8)

Many organisms used in the above experiments were tested in suspensions containing 5% normal horse serum, and also in suspensions made from growths on agar containing 5% serum. This was done with a view to correlating the results with those in the air-sterilization tests with similarly prepared suspensions. As was to be expected, in the vast majority of instances a greater concentration of germicide was required when serum was present, the organisms

which showed the greatest increase in resistance being the *Corynebacterium* group. The effect of adding serum to the suspensions seemed to be greater than the growing of the organisms on serum agar.

When we tested benzyl-cresol and hexyl-resorcinol by the method just described we confined ourselves to using only selected organisms half-way down our list of resistance, i.e. "F" coccus, *Str. agalactiae* and *Str. pyogenes*. With benzyl-cresol the killing dilutions were found to be 1/6000, 1/8000 and 1/9000 respectively, an order different from that obtained with thymol water, in spite of the fact that *Str. pyogenes* was of necessity only grown on serum agar. With hexyl-resorcinol the killing strength for the "F" coccus was 1/6000.

Having obtained some idea of the lethal dilution required for certain organisms we proceeded to extend the tests for determination of the individual lethal dose. It was found necessary for practical reasons to alter the time basis and the organisms. The test time was extended to 30 min. and *Saccharomyces cerevisiae* and *E. coli* were used because large bulks of organisms were required.

The procedure adopted was, in the first place, to enumerate the number of organisms in 1 g. of centrifuged emulsion, the consistency of the deposit being regulated by spinning time, etc. The yeast emulsions were suitably diluted and counted in an haemocytometer, the *E. coli* being estimated by opacity. The percentage survival when using various dilutions of germicide over different periods of time was then ascertained, the unabsorbed germicide remaining in the supernatant fluid being titrated colorimetrically. Having obtained information as to the most economical dilution of germicide and the best period of time to be used we next proceeded to vary the number of bacteria placed in contact with a constant amount of germicide for a constant time. A time period of about 30 min. appeared to be the best, because it was long enough for maximum absorption possible to take place and because it appeared that rediffusion of the germicide into the surrounding fluid occurred after death of the bacteria.

We found 1 g. of moist yeast contained very approximately 3×10^{10} cells, and 1 g. of *E. coli* about 60×10^{10} cells. The maximum kill obtained with 1 g. of hexyl-resorcinol was 117 g. of yeast and 375 g. of *E. coli*, but in neither case was the end-point reached. In Table 30 it has been shown that 0.004 g. of this germicide was sufficient to kill the average 20 g. mouse, and for convenience we may consider that 1 g. of the germicide was capable of killing 5000 g. of mouse tissue, perhaps an amount ten times greater than of *E. coli*. If these figures are of the right order, though possibly they may not be, the host-parasite toxicity ratio would be 10 : 1. This ratio appears to be in the wrong direction to that which superficially might be hoped for, but it will be realized that the lesser sensitivity of the bacterium is to be expected. Not, however, because the germicide would be expected to cause death by intoxication of a small, vital organ of the Metazoa, for it is not to be supposed that all the germicide finds its way to such vital organs, the major portion of it being absorbed by tissues to which it is far from lethal in the dose absorbed. As a matter of fact, in the animal, as in the micro-organism, there is a wastage of germicide, which in turn brings us to a consideration of the relative efficacy of

a given germicide as a killer in the air and in the test-tube. In other words, wherein is there the greater wastage of germicide?

It is easy by considering the conditions under which our numerous experiments were carried out and the results obtained to get an idea of the number of bacteria killed by a given quantity of germicide. As an example we found that 1 g. of benzyl-cresol used to good advantage would kill 1×10^{10} of the "F" coccus in the air, and twice this number in the test-tube. From what has been said on the subject of the individual lethal dose it is clear that the wastage of germicide in our experiments is enormous in both instances. This must of necessity be so because our experiments are designed to kill all, or almost all, the bacteria present in the test, and in effect it is a titration of the lethal dose, not of the average organism, but of the most resistant member whatever may be the factors responsible for the resistance. Presumably the answer to the question depends upon the germicide under test, but in any case the establishment of the degree of wastage with any accuracy necessitates careful carrying out of numerous titration absorption tests wherein at least no more than a 60% kill is aimed at.

GENERAL DISCUSSION

The experiments carried out were undertaken to gain information as to the possibility of preventing air-borne contamination of man, animals, plants and inanimate materials by means of germicidal aerosols. We are of opinion that the information we have gained points to the great possibilities of this line of approach for preventing infection, and venture to think that the method will ultimately prove of practical value in prophylactic medicine. We shall, of course, be in a much stronger position if we are able to confirm Trillat's experiments consisting of infecting animals by exposing them to air contaminated with virulent bacteria, and preventing such infection by treatment of the contaminated air with "Aéryl". On the assumption that we are successful in this respect on substituting "S²" for "Aéryl"¹, and also when contamination of the air by diseased animals is substituted for contamination with laboratory cultures, we shall have reason to believe that in all probability we shall be able to control with equal facility human infection due to similar types of micro-organisms.

Some of the commoner afflictions of man in which we hope to render useful service are: streptococcal sore throat, etc., cerebro-spinal fever, diphtheria, tuberculosis, pneumonia, etc., but our ultimate goal is the prevention of the spread of virus diseases.

The most difficult conditions under which aerial disinfection might be applied in order to prevent infection are those in which man would be exposed, perhaps for hours on end, to the continual inhalation of air containing germicide, and although he might not complain of untoward effects on the senses, nevertheless, it has to be borne in mind that the germicide might not be

¹ In tentative experiments we have since shown this to be possible.

altogether harmless in certain respects. We have in mind such symptoms as dryness of the throat, headache, giddiness, etc., and it is in view of these possibilities that we have performed tests on man exposed for many successive hours to atmospheres containing varying concentrations of different germicides of graded particle size. We are of the opinion, without, however, being absolutely convinced, that as far as S^2 is concerned, the smaller the particle the better is the mist tolerated by the throat. That is to say, in the mist concentrations of this germicide likely to be used in practice, the only evidence of intolerance we have noted has been a slight pricking sensation on the fauces when using a somewhat high concentration of ungraded mist containing many particles about 2μ in radius, and the concentration was somewhat high. When the particle size is small, i.e. of a radius of 1μ downwards, there is never any sense of throat irritation even when the test subject is enveloped in a dense mist, but under these conditions there is a feeling of suffocation, which may persist for some time after removal of the subject to the open air. In veterinary practice and under many other circumstances the question of tolerance, of course, diminishes in importance.

The position as regards our findings with plate cultures from air experiments may be summarized in terms of survivors when the germicide is and is not present, the former being expressed as a percentage of the latter. We have found that at a concentration of about 1 g. of germicide mixture in 4000×10^6 c.c. of air (0.00025 g./cu.m.) the number of bacteria in a broth emulsion which are viable at the end of a quarter of an hour varies with the type of organism, and other factors. *E. coli* and some micrococci may be completely destroyed, while perhaps 1 in every 400 *C. xerosis* and 1 in every 4 *M. phlei* may survive. In the case of atomized saliva, death of the bacteria present is not so easy of attainment, and the concentration of germicide mist has to be raised sometimes, but not always, tenfold or more in order to obtain sterility, even in half an hour. A suitable mist of our germicide, designated " S^2 ", is apparently tolerated perfectly by man, when in a concentration of 1 g. in 200×10^6 c.c. of air, equal to 1 of germicide base in 2000×10^6 c.c. of air.

It is thus plain that we have been successful in killing within a short time, with a germicidal mist apparently quite harmless in all respects for man, the majority of bacteria artificially suspended in the air, while it is probable that at least most of the survivors have been sufficiently damaged by the action of the germicide to render them avirulent. We see no reason why pathogenic bacteria escaping into the air from an infected individual should not be killed with equal ease, but confirmation of this opinion has yet to be obtained by experiment. In any case, we anticipate that, broadly speaking, germicidal aerosols will prove of greater utility in eliminating pathogenic than in eliminating saprophytic bacteria. Thus we imagine that the method will turn out to be of more value in the sick room than in the operating theatre.

There are many factors relating to lethal effectiveness of a phenolic germicide about which we have gained valuable knowledge. Thus:

(1) Lethal effectiveness in the air does not run parallel to lethal effectiveness *in vitro*.

(2) Vapours of the germicide are useless for our purpose. On the other hand, to get the maximum effect in the air from a given quantity of our germicide mixture the particle size should not be too large; something below 1μ being the upper limit with, meanwhile, some doubt as to the lower limit except, as we have said, that it is certainly not mono-molecular.

(3) The persistence of the mist depends upon the ingredients making up the mixture, but this persistence cannot necessarily be foreseen from a knowledge of the vapour pressures of the constituent germicide and solvent.

(4) Maximum lethal effectiveness is not proportional to the amount of germicide base in the aerosol mixture. A mixture which is half as strong as another *in vitro* may not be one-tenth as effective as an aerosol.

It thus follows that, in setting out to keep the air in a given closed atmosphere as free as possible from dangerous bacteria, we must know the time of air turnover, for upon this will depend not only the amount of germicide to be generated per unit time, but also the most suitable particle size of mist droplets which should be selected. The time the germicide particle persists should roughly correspond to the time of turnover of air.

For example, let us assume that we have a room of 1000 cu.m. capacity, with an air turnover every 12 min., and containing 100 persons. In order to minimize the risk of infection from one individual to another it is proposed to maintain in the air a mist of S^2 at a concentration of 1 g. to 200 million c.c. of air. This means that the machine must be capable of atomizing 5 g. of the germicide mixture every 12 min., or 25 g./hr. in order to maintain the required concentration (this concentration having been previously attained). Under these conditions the particle size of the mist droplets should not be above 1μ and not less than 0.5μ . If the atomizer used delivers mist above this limiting size then the larger particles must be removed by a selector centrifuge placed between the generator and its outlet, and due allowance will have to be made for the weight of germicide mixture thereby removed; while if a high proportion of the particles happens to be very small, this is of no account as the volume of material involved is not great, and in any case it is more difficult to remove small than large particles from a mixture of varying size particles. The gross output of such a machine would thus have to be increased to an amount equivalent to that removed by the selector. In some machines this may amount to a tenfold increase, but we have designed a machine in which it is so small as to be for practical purposes negligible.

The position of the inlet or inlets for the germicide mist is the concern of ventilating engineers, and proof by chemical test that the mist is being equally distributed must be obtained before the method is put into practice. Temperature conditions would also have to be taken into consideration because of their effect on the persistence of the particles.

Although a mist of "Aéryl", when not too concentrated, is relatively well

tolerated, our experimental results show clearly wherein lie the greater merits of our own germicide mixture, "S²". Roughly, these merits may be quantitatively assessed as being:

- (1) in equal mist concentrations two to ten times more powerfully germicidal on broth emulsions of bacteria suspended in the air, and in low concentrations also on the bacterial flora of the saliva;
- (2) one-tenth or less as toxic for the animal; and
- (3) a persistence in the atmosphere originally free from vapour about fifty times as long, and, therefore, usable as a mist of much finer particles.

SUMMARY

A form of ultramicroscope apparatus is described which enables the evaporation of mist droplets to be followed for long periods. A rough method of estimating the size distribution in aerosols is also given.

The rates of evaporation of particles of various phenol solutions have been studied, the solutions chosen being of possible interest as aerial germicides. It is shown that the typical evaporation curve for a binary mixture consists of three parts, which in actual cases need not all be present. Sometimes the more detailed history of an evaporation can be deduced from the results.

The approximate effective size distributions in mists of hexyl-resorcinol—propylene-glycol solutions have been measured and compared with the evaporation rates.

It is shown that the efficiency of aerial germicides is partly a function of their volatility, and three rough classes are distinguished. But biological evidence is adduced which suggests that the solubility of the germicides in water may be of equal importance, and that the liquid in which the germicide is dissolved is not without effect.

A centrifuge is described which enables the maximum particle size in a mist to be limited to a desired value.

Methods of estimating quantitatively germicidal aerosols are discussed, and a method described which has been found to give reasonably accurate results in practice. Tentative experiments have been made to determine whether the materials studied are likely to cause corrosion of metals, etc., after prolonged use.

The collision theory of aerial disinfection is discussed, as is also the applicability of Langmuir's treatment of the evaporation of fine particles in mixtures.

The development of the experimental technique involved in the biological investigations appertaining to air disinfection has been discussed, together with the numerous fallacies arising and the means by which these have been overcome.

The construction of a special pair of experimental chambers is described, and details given, both as regards the bacteria and germicides, of the exact experimental conditions under which the most consistent results can be obtained.

The requisite characteristics of germicidal mixtures which could be utilized for air disinfection are considered, and examples of suitable germicides and solvents are given. The method of recording and evaluating the results of a varied assortment of experiments is explained to facilitate *inter se* comparison.

Examples are given of the lethal effectiveness in the air of several germicides in broth emulsions, both with and without the presence of serum, on stock cultures of selected types of bacteria. The sensitivity to the germicides of the bacteria making up the flora of the average normal saliva is compared with that of broth emulsions of bacteria.

10% hexyl-resorcinol dissolved in propylene-glycol + 0.05% sulphonated lorol ("S²") was the most effective all round germicidal mixture of those tested. Various other germicides were found equal in germicidal activity in the air, but for reasons stated have been deemed unsuited for use in the presence of man.

The relationship between germicidal efficiency in the air and mist particle size and persistence has been studied by means of centrifuged mists. Particles of 0.5–1.0 μ radius are shown to be the most useful in dealing with bacterial particles containing organic matter. Laboratory cultures, emulsified in broth, have been sterilized in mist dispersions by droplets of bactericides at least as small as 0.25 μ radius.

Tests on the penetrating abilities of bactericidal mists and bacteria through certain cloths have been performed.

Experiments to demonstrate the surface sterilizing properties of aerosols have been performed, and examples of differences in effect on horizontal and vertical surfaces are noted.

The degree of tolerance of man and animals (mice) for a number of phenolic substances and some organic solvents has been compared with the degree of tolerance of bacteria for the same substances.

The tests on man have been confined to the detection by the special senses of the substances suspended in the air as a fine mist.

The tests on animals were designed to show acute and chronic effects, the results being recorded in terms of clinical symptoms and pathological changes in the organs. A record was also kept of the findings as regards protozoal parasites of the host, and compared with the normal incidence among ordinary laboratory stock.

Tests on bacteria were instituted for the purpose of gaining information on the host-parasite tolerance ratio for our germicides when in the air and when in the test-tube.

GENERAL CONCLUSIONS

The general conclusion we draw from the present investigations is that aerial disinfection by means of germicidal mists is a procedure which under some circumstances may turn out to be a valuable prophylactic measure in combating air-borne infection. The possibilities of our being able to render

useful service in this direction rest entirely upon the results of future experiments on animals, wherein we shall attempt to infect through the medium of the air and, if successful, to prevent such infection with germicidal aerosols. It would seem, from our experience, that if aerial disinfection by the methods described is a practical proposition for preventing the infection of one individual by another then our mixture designated "S²" is the only germicide at present available likely to be of use. It would appear that the proprietary product designated "Aéryl", although excellent in some respects, not only has to be used as a relatively concentrated mist, but is also more toxic for the animal economy.

For a germicide to be of use in aerial disinfection it seems that it should have a low vapour pressure, or if the vapour pressure be high this must be compensated for by rapidity of action. There are indications that the latter is allied to water solubility¹, and accordingly we are now searching for germicides with a low vapour pressure, high water solubility and at least a moderate degree of activity *in vitro*. Needless to say, we would welcome the co-operation of those who make a special study of germicides, and would gladly submit to aerial test compounds selected as likely to be of utility in our present field of research.

In conclusion, we would like to express our appreciation of the whole-hearted support received from the Directors during these researches, and are grateful for the facilities they have afforded us, and for permission to publish our results. Our thanks are also due to Mr R. O. Bishop, F.I.C., the General Manager, for his encouragement and interest in the work, as well as for advice in many directions received from him and other members of the Works Staff.

On the scientific side, the valuable advice freely given from time to time by Prof. F. W. Twort has been greatly appreciated, and we also wish to record our indebtedness to Mr C. L. Hunter, B.Sc., and Mr J. A. Haynes for their technical assistance in carrying out many of the bacteriological bench and chamber tests involved in these investigations. The maintenance of the animals, performance of post-mortem examinations and preparation of histological specimens have been the responsibility of Mr F. Dixon. We wish to record our appreciation of the care and technical skill bestowed upon the great amount of material passing through his hands.

¹ On the other hand we have found that sodium salts and sulphonates of certain phenols are relatively inactive.

REFERENCES

- Air analysis, Report of Sub-Committee on Bacteriological Procedures of. Year Book, 1936-7. Supplement. Amer. J. Publ. Hlth, 1937, 27, No. 3.*
- BECHHOLD, H. (1935). Improvements in rendering micro-organisms innocuous. British Patent No. 472,623.
- CHICK, H. & MARTIN, C. J. (1908). The principles involved in the standardization of disinfectants and the influence of organic matter upon germicidal value. *J. Hyg., Camb.*, **8**, 654-703.
- COULTHARD, C. E., MARSHALL, J. & PYMAN, F. L. (1929). The variation of phenol coefficients in homologous series of phenols. *J. chem. Soc.* 1930, pp. 280-91.
- CUNNINGHAM, E. (1910). On the velocity of steady fall of spherical particles through fluid medium. *Proc. roy. Soc. A*, **83**, 357-65.
- FINN, S. R., POWELL, E. O. & SHEPHERD'S INDUSTRIES LTD. (1939). Aerosol centrifuge. British Patent Application No. 17,525.
- FOLPMERS, T. (1934). Determination of traces of phenols in surface water. *Chem. Weekbl.* **31**, 330-3. Cited in *Brit. Chem. Abstr.* B (1934), **53**, 606.
- DE FORCRAND (1901). Vaporisation et hydratation du glycol éthylique. *C.R. Acad. Sci., Paris*, **132**, 689-95.
- FUCHS, N. (1934). Zur Theorie der Koagulation. *Hoppe-Seyl. Z. A*, **171**, 199-208.
- HOUGHTON, G. V. & PELLY, R. G. (1937). A colorimetric method for the determination of traces of phenol in water. *Analyst*, **62**, 117-20.
- LANGMUIR, I. (1918). The evaporation of small spheres. *Phys. Rev.* (2), **12**, 368-70.
- LISTER, J. (1868). An address on the antiseptic system of treatment in surgery. *Brit. med. J.* **2**, 53-6, 101-2, 461-3, 515-17.
- MORSE, H. W. (1910). On evaporation from the surface of a solid sphere. *Proc. Amer. Acad. Arts Sci.* **45**, 363.
- NIEDERL, J. B. *et al.* (1938). Diisobutylphenol. *Industr. Engng Chem. Industrial Ed.* **30**, 1269-74.
- PULVERTAFT, R. J. V., LEMON, G. J. & WALKER, J. W. (1939). Atmospheric and surface sterilization by aerosols. *Lancet*, **1**, 443-6.
- PULVERTAFT, R. J. V. & WALKER, J. W. (1939). The control of air-borne bacteria and fungus spores by means of aerosols. *J. Hyg., Camb.*, **39**, 696-708.
- SCARPA, O. (1939). Sulla necessità di ammettere affinità chimica fra solvente e soluto. *R.C. Accad. Lincei*, **29**, 247-53.
- SHEPHERD, T. L., FINN, S. R., POWELL, E. O. & SHEPHERD'S INDUSTRIES LTD. (1939). Improvements in aerosols particularly those having germicidal, disinfecting, insecticidal or medicinal qualities. British Patent Application No. 21,820.
- SIEDENTOPF, H. & ZSIGMONDY, R. (1903). Über Sichtbarmachung und Grossenbestimmung ultramikroskopischen Teilchen, mit besonderer Anwendung auf Goldrubingläser. *Ann. Phys., Lpz.* (4), **10**, 1-39.
- v. SMOLUCHOWSKI, M. (1916). Versuch einer mathematischen Theorie der Koagulationskinetik kolloider Lösungen. *Hoppe-Seyl. Z.* **92**, 129-68.
- TAUZIN, P. (1939). Ultramicroscopie à grande distance frontale pour l'étude des aérosols. *C.R. Acad. Sci., Paris*, **209**, 27-30.
- TRILLAT, A. (1938*a*). Les aérosols microbiens: applications. *Bull. Acad. Méd., Paris*, (3), **16**, 49-57.
- (1938*b*). Propriétés des aérosols microbiens: applications. *Ann. Hyg. publ., Paris*, **119**, 64-72.
- (1939). Aérosols microbiens (Historique). Sur leur rôle dans la contagion et sur leur stérilisation. *Rev. Path. Comp.* **39**, 292.

- TRILLAT, A. & FOUASSIER, M. (1912). Action des doses infinitésimales de diverses substances alcalines fixes ou volatiles sur la vitalité des microbes. *C.R. Acad. Sci., Paris*, **155**, 1184-6.
- (1914). Influence de la radioactivité de l'air sur les gouttelettes microbiennes de l'atmosphère. *C.R. Acad. Sci., Paris*, **159**, 817-19.
- TWORT, C. C. (1913). The rapidity with which contamination of the thoracic cavity and its contained glands follows infection of the peritoneal cavity. *Lancet*, **2**, 216-18.
- TWORT, C. C. & LYTH, R. (1935). A new method for measuring carcinogenicity. *J. Hyg., Camb.*, **35**, 125-9.
- TWORT, C. C., LYTH, R. & TWORT, J. M. (1936). The significance of density, refractive index and viscosity of mineral oils in relation to the type and degree of animal reaction. *J. Hyg., Camb.*, **37**, 14-29.
- TWORT, J. M. & TWORT, C. C. (1932). Disease in relation to carcinogenic agents among 60,000 experimental mice. *J. Path. Bact.* **35**, 219-42.
- WELLS, W. F. (1935). Air-borne infection and sanitary air control. *J. industr. Hyg.* **17**, 253-7.
- (1936). *Centrifuging apparatus*. U.S. Patent No. 2,043,313.
- (1938). Air-borne infection. *Mod. Hosp.* **51**, 66.
- WELLS, W. F. & BROWN, H. W. (1936). Recovery of influenza virus suspended in air and its destruction by ultraviolet radiation. *Amer. J. Hyg.* **24**, 407-13.
- WELLS, W. F. & FAIR, G. M. (1935). Viability of *B. coli* exposed to ultraviolet radiation in air. *Science*, **82**, 280-1.
- WELLS, W. F. & WELLS, M. W. (1936). Air-borne infection. *J. amer. med. Ass.* **107**, 1698-703.
- (1938). Measurement of sanitary ventilation. *Amer. J. Publ. Hlth*, **28**, 343-50.
- WHYTLAW-GRAY, R. & PATTERSON, H. S. (1932). *Smoke*, 1st ed. 188 pages, 12 plates, 33 diagrams. London: Edward Arnold and Co.
- WHYTLAW-GRAY, R. & SPEAKMAN, J. B. (1932). Smokes. Part II. A method of determining the size of particles in smokes. *Proc. roy. Soc. A*, **102**, 615-27.
- WHYTLAW-GRAY, R., SPEAKMAN, J. B. & CAMPBELL, J. H. P. (1922). Smokes. Part I. A study of their behaviour and a method of determining the number of particles they contain. *Proc. roy. Soc. A*, **102**, 600-15.

(Received for publication 12. II. 40.—Ed.)

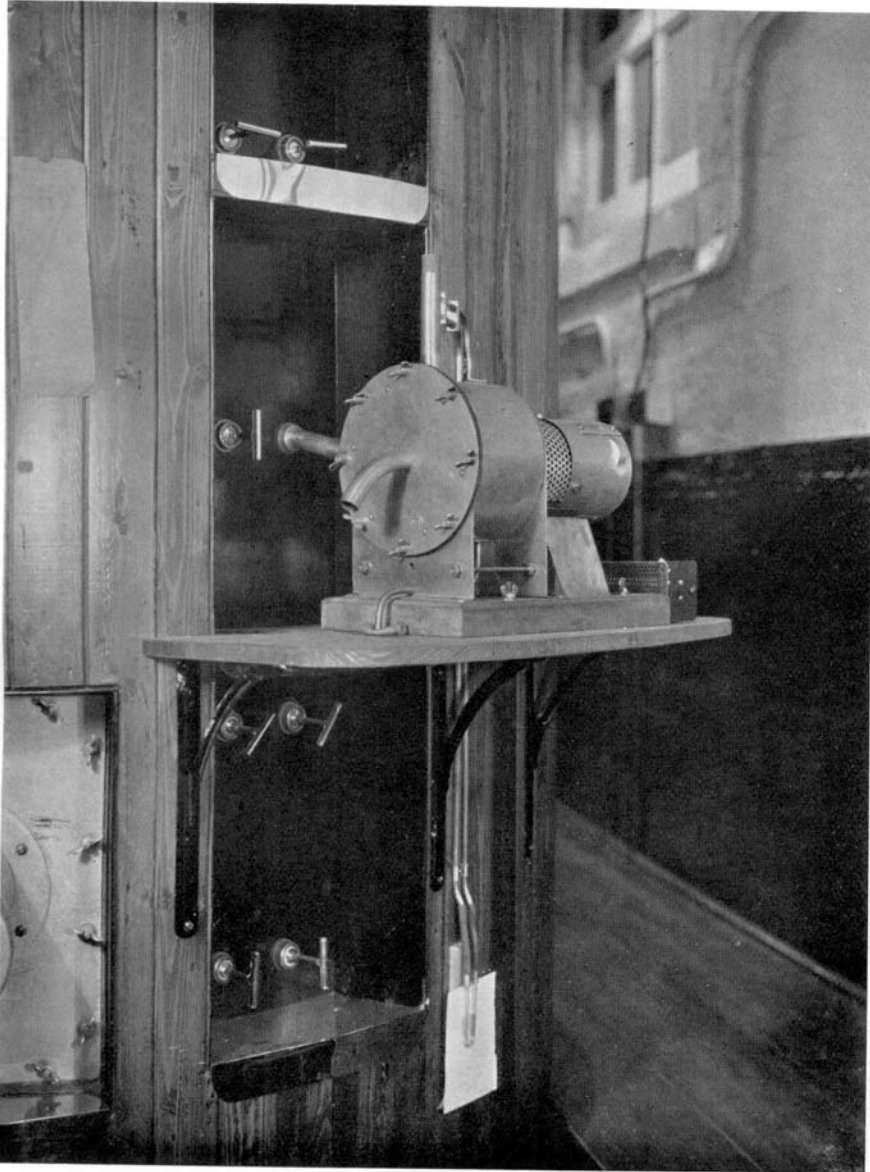

Mist-grading centrifuge.

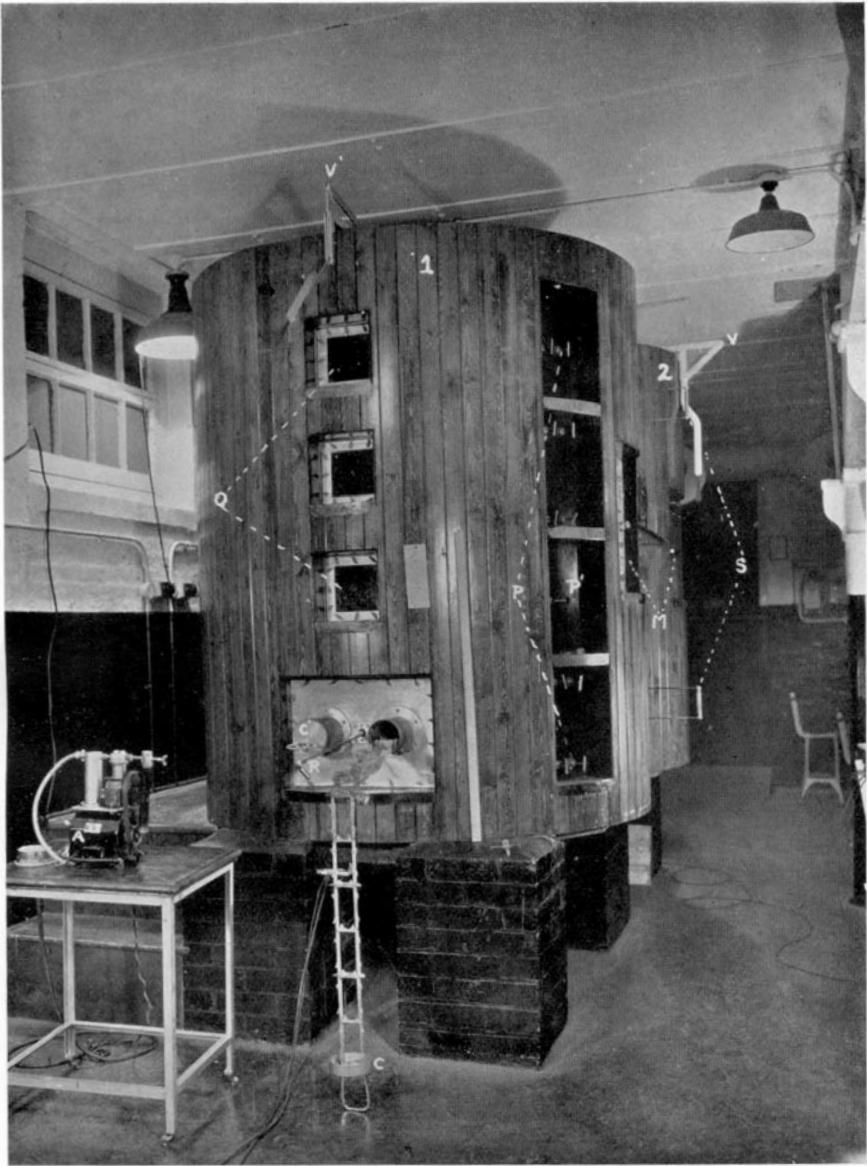

Test chambers.

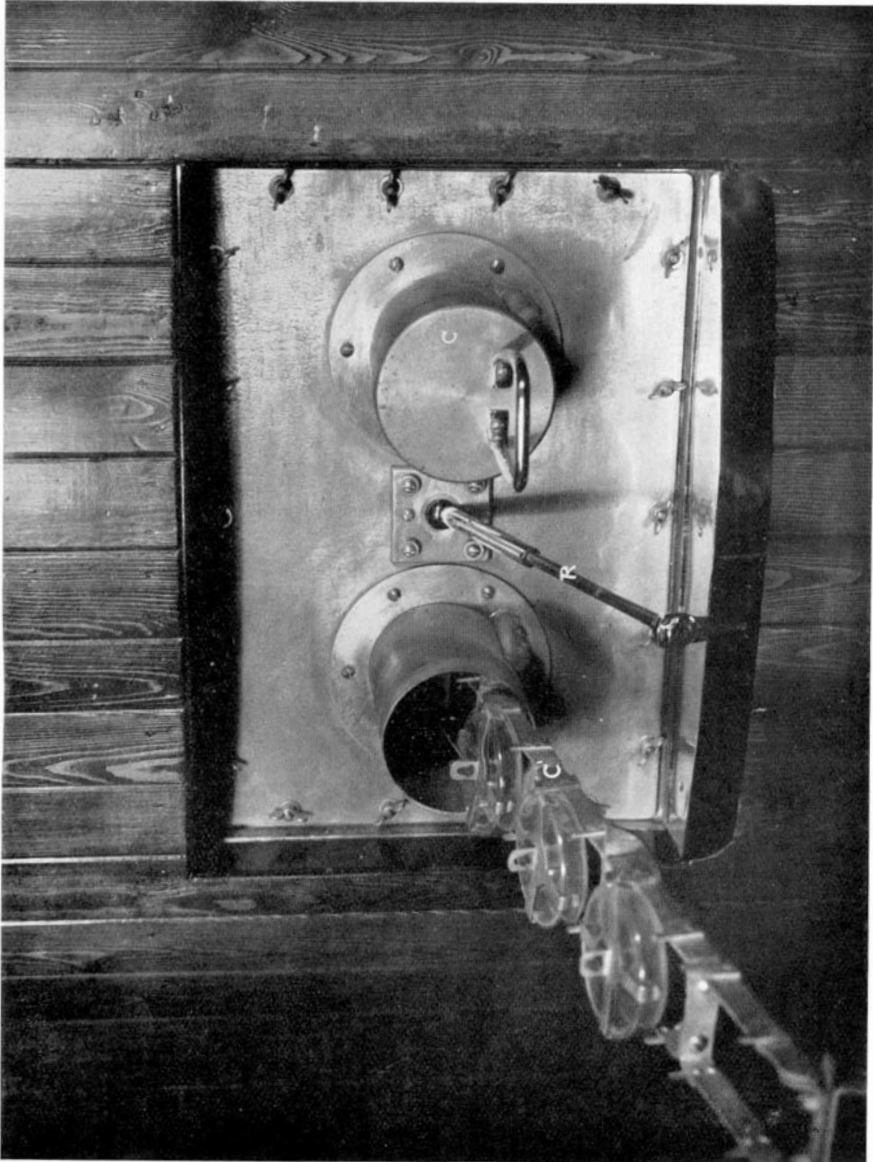

Plate carrier.