

## THE TOXICITY OF ATMOSPHERES CONTAINING HYDROCYANIC ACID GAS.

BY JOSEPH BARCROFT.

*(From the War Department, Experimental Station.)*

(With 23 Text-figures.)

### CONTENTS.

	PAGE
I. Introduction . . . . .	1
II. The determination of toxicity-concentration time curves . . . . .	2
(a) Literature . . . . .	2
(b) Experimental . . . . .	2
(c) Toxicity curves of different mammals and birds . . . . .	4
III. Mode and seat of action of HCN vapour . . . . .	19
IV. The specific action of hydrocyanic acid inhaled in low concentrations . . . . .	24
V. The toxicity of HCN to man when inhaled . . . . .	24
VI. The concentration necessary to produce unconsciousness . . . . .	25
VII. General comparison between mammals and birds . . . . .	27
VIII. The concentration necessary to make pigeons vomit . . . . .	27
IX. Indicators . . . . .	29
X. Treatment . . . . .	30
(a) Efficacy of artificial respiration . . . . .	30
(α) Dissipation. (β) Destruction . . . . .	32
(b) Administration of glucose . . . . .	32
(c) Administration of nitrites . . . . .	33

### I. INTRODUCTION.

THE lethal dose of an ordinary pharmacological preparation is expressed in a simple statement of quantity. The lethal dose of a poisonous gas cannot as a rule be so expressed. The majority of such gases are rapidly destroyed in the body, and the building up of a lethal concentration in some critical portion of the organism is a race between the rate at which the gas is inhaled and the rate at which it is destroyed. Even in the cases of such gases as arsenuretted hydrogen which are destroyed only very slowly, and which are therefore cumulative poisons, the attainment of a lethal concentration in the body is a function not only of the concentration of the gas in the atmosphere, but of the time during which that atmosphere is breathed.

As the fatal dose of a poisonous gas is best expressed by a curve which relates the concentration of the gas in the atmosphere to the length of time for which it is inhaled, if this curve could be represented by an equation (as in some cases it approximately can be), that equation would be the statement of the dose. During the great war it was the universal practice among the belligerent nations to state the toxicity of gases by concentration-time curves.

A consideration of the toxicity of hydrocyanic gas therefore from the basal data furnished by the concentration-time curves for various forms of life is here presented. At first those for some typical mammals will be considered.

The ultimate interest in these curves lies largely in their applicability to human beings. We have little *a priori* knowledge of the principles which underlie the transference of the effects obtained on any particular animal to man. One drug, carbon monoxide, will kill a mouse quickly, where it will only kill a man slowly; another, atropine, will kill a man in doses which have little effect on animals.

In the case of hydrocyanic acid we know little of the laws which govern its absorption by the lung. We know less about the laws which govern its destruction in the body, and least of all about its precise method of attack.

For all these reasons it will be best to start our investigation on broad lines, using animals of very different sizes and very different habits. There is a high degree of probability that, if we know the whole range of toxicity curves for the animal creation, the toxicity of the gas to man will be of the same general order.

## II. THE DETERMINATION OF TOXICITY-CONCENTRATION TIME CURVES.

### (a) *Literature.*

There are no published curves, so far as I know, relating the time of exposure, the concentration of hydrocyanic acid in the air and the prospect of life. Here, let me say, that if I have done less than justice to work carried out in other countries, notably the Central European Powers, it is because during the war, from the very nature of the case, I had no access to their published work.

Some figures of a not very systematic character are given by Henderson and Haggard (1927).

### (b) *Experimental.*

Experiments of the following type were designed to secure more accurate information on this subject.

As a sample experiment four goats were put in an airtight chamber 10 cubic m. in capacity. This chamber was made of sheets of plate glass held together by a steel frame. It contained an electric fan for the purpose of stirring the air, and could be entered from an airlock about 2 cubic m. in capacity.

The operator went in wearing a respirator and taking with him a sealed glass tube which contained the required quantity of hydrocyanic acid; in the present case 3.6 gm. With the door shut the tube was broken in the vicinity of the fan, and the hydrocyanic acid poured out. It evaporated immediately, the air as well as being stirred by the fan was stirred by a large piece of cardboard or paper waved by the operator.

The animals were exposed to this atmosphere which contained "a nominal

concentration of 0.36 mg. of HCN per litre" for 15 minutes (the same figure stands for gm. per cubic metre), after which time the chamber was opened and the animals were withdrawn. Of the four goats, one died and three recovered. The result of the experiment was plotted on a graph in which the ordinate is the concentration of prussic acid, and the abscissa the time of exposure. On such a graph an  $\times$  indicates that the animal died, and an  $\circ$  that it recovered.

By "a nominal concentration" as used above is meant the calculated concentration on the assumption that the material in the tube was pure HCN, that it was all dissipated in the air, and that it remained there. These assumptions are of course "councils of perfection," especially the last, for apart from the possibility of gas being adsorbed on the glass surface, there remains the fact that a considerable amount was inhaled by, and remained in the goats. No effort was made to reinforce the atmosphere in order to compensate for loss. The "nominal concentration" is therefore the "superior limit of concentration."

The order of errors involved in the falling off of the concentration of gas during an experiment may be gathered from the following experiment.

Table I.

Concentration of HCN in air at commencement	Concentration of HCN in air at end	Loss in 38 min. (%)
0.231 mg./litre (1 part in 5250)	0.180 mg./litre (1 part in 6750)	22

Reverting to the experiment under discussion, it was one of a series, the whole results of which are shown in Fig. 1. (Here the concentration of gas is represented in two ways; on the left the molecular concentration, the number of volumes of air which contain 1 volume of prussic acid, according to which the figure includes ranges of between one part of HCN in 1000, and one part in 100,000 of air: on the right-hand side the concentration is expressed in mg./litre.)

Two other experiments were carried out at a concentration of 0.36 mg./litre; at 20 minutes three goats died, and one lived. At 24 minutes all four had died.

Fig. 1 is the result of 18 experiments, with various concentrations of gas, and for various times of exposure. As a result it is possible to draw a curve such that, if a goat is exposed for the specified time to the specified concentration, the chance of its dying will be equal to that of its recovery. This is known as the toxicity curve.

The only points that need be noted here are that the relationship between the "time" and the "dose" is not a simple one (in the case of cumulative poisons it is more nearly hyperbolic), and secondly that the curve at low concentrations becomes parallel to the base line, indicating that there is a limiting concentration of 0.24 mg./litre (1/5000) less than which the average goat could tolerate for an unlimited period.

A general discussion of the theoretical relationship of the factors which

*Hydrocyanic Acid Gas*

involve the rate at which a gas is absorbed are given by Henderson and Haggard (1927).

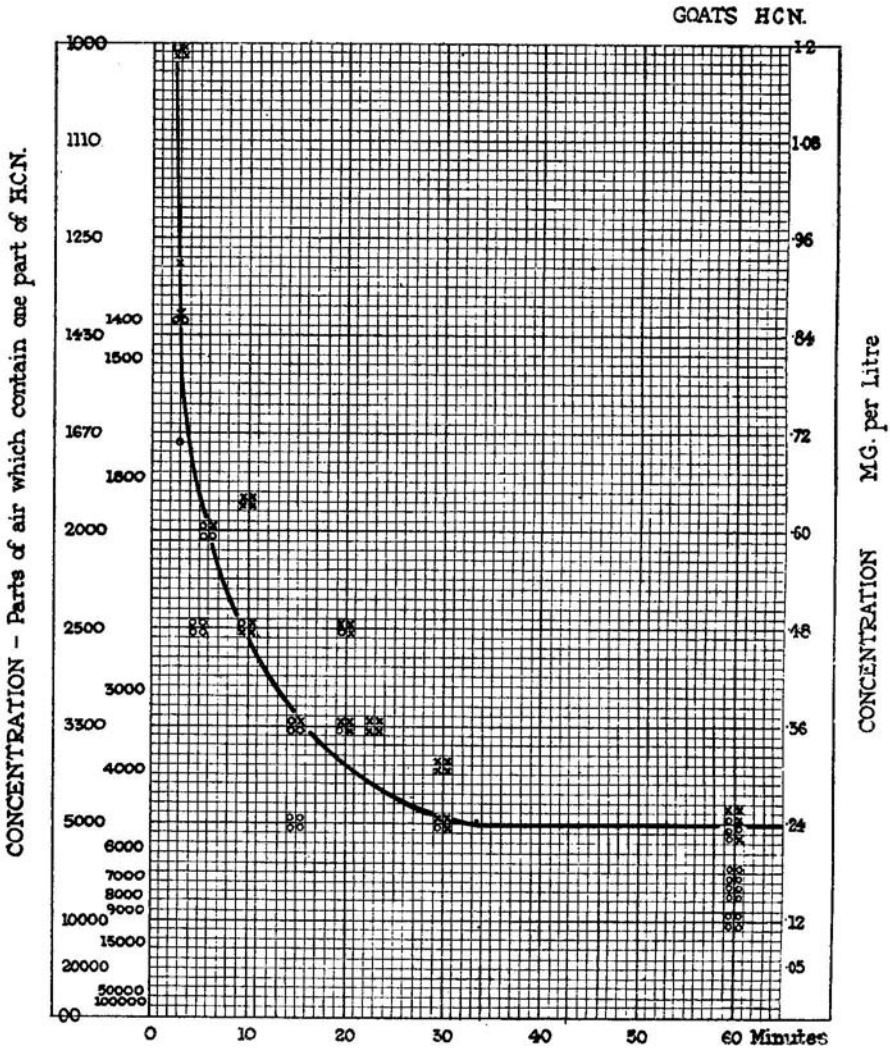


Fig. 1. Shows the prospect of life of goats exposed to atmospheres containing HCN. Ordinate = concentration of HCN in the air. On the left-hand side this is expressed in "molecular" concentration, *i.e.* the number of parts of air by volume which contain 1 part of HCN. On the right the concentration is given in mg. per litre. Abscissa = minutes of exposure of the animal to the gas.  $\times$  = the goat died as the result of exposure to the atmosphere.  $\circ$  = the goat survived. The curve, therefore, approximately indicates that for a given concentration and time the goat had a 50 per cent. chance of surviving.

(c) *Toxicity curves of different mammals and birds.*

Figs. 2-11 show the toxicity curves for monkeys, rabbits, rats, cats, dogs, guinea-pigs, mice, fowls, pigeons and canaries, and except in the case of guinea-pigs, the data on which they are based.

The curves obviously differ greatly; inspection of the actual data on them shows that the difference is far beyond the experimental errors involved.

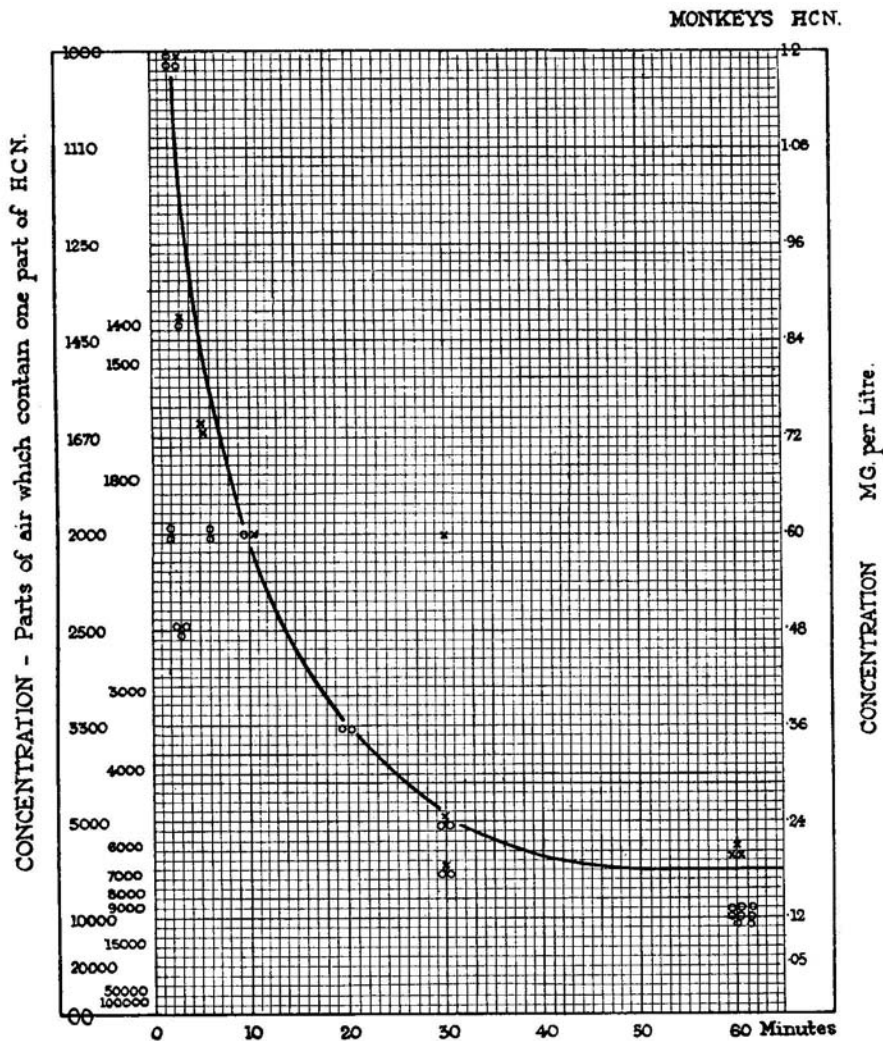


Fig. 2. Shows the prospect of life of monkeys when exposed to atmospheres containing HCN. Scales, etc., as in Fig. 1.

Figs. 12-14 show the individual curves in the preceding experiments superposed. They bring out the fact that there is considerable crossing of the curves.

At the highest concentration about which it is possible to speak with much certainty, about 1.08 mg./litre, the mammals stand in the following order from the most to the least sensitive.

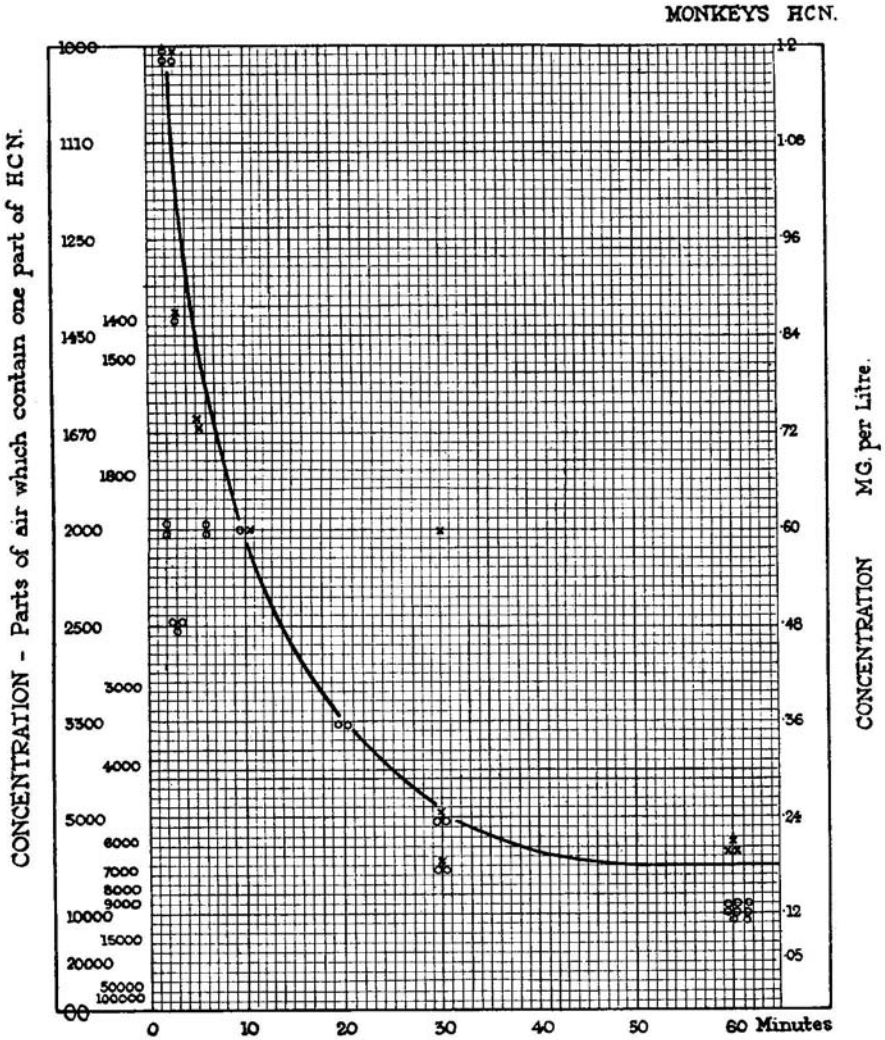


Fig. 3. Shows the prospect of life of rabbits when exposed to atmospheres containing HCN. Scales, etc., as in Fig. 1.

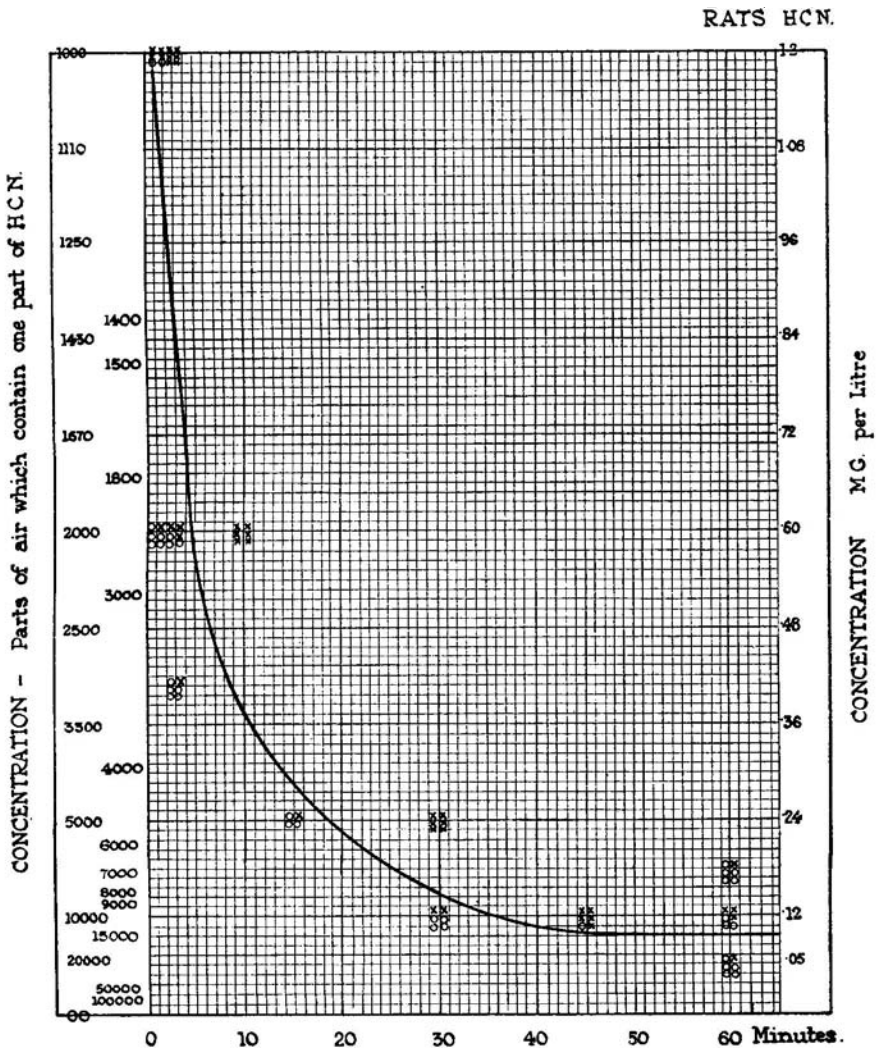


Fig. 4. Shows the prospect of life of rats when exposed to atmospheres containing HCN. Scales, etc., as in Fig. 1.

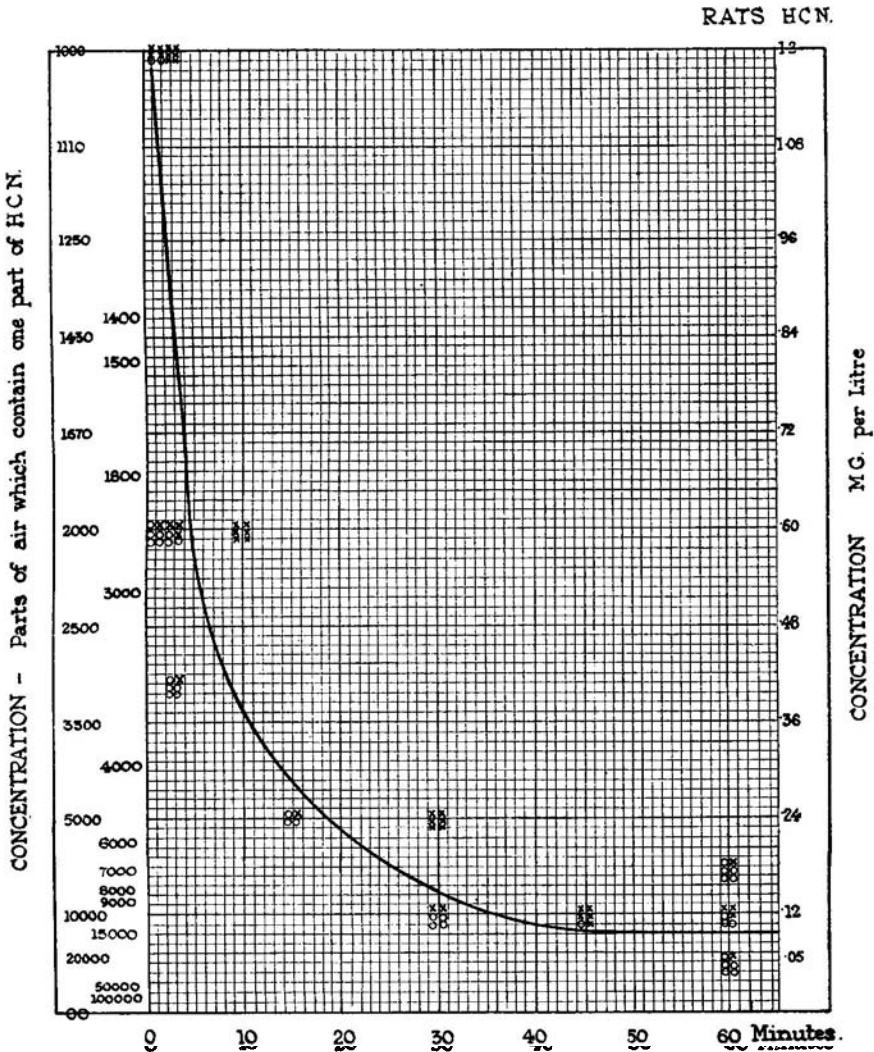
*Hydrocyanic Acid Gas*

Fig. 5. Shows the prospect of life of cats when exposed to atmospheres containing HCN. Scales, etc., as in Fig. 1.



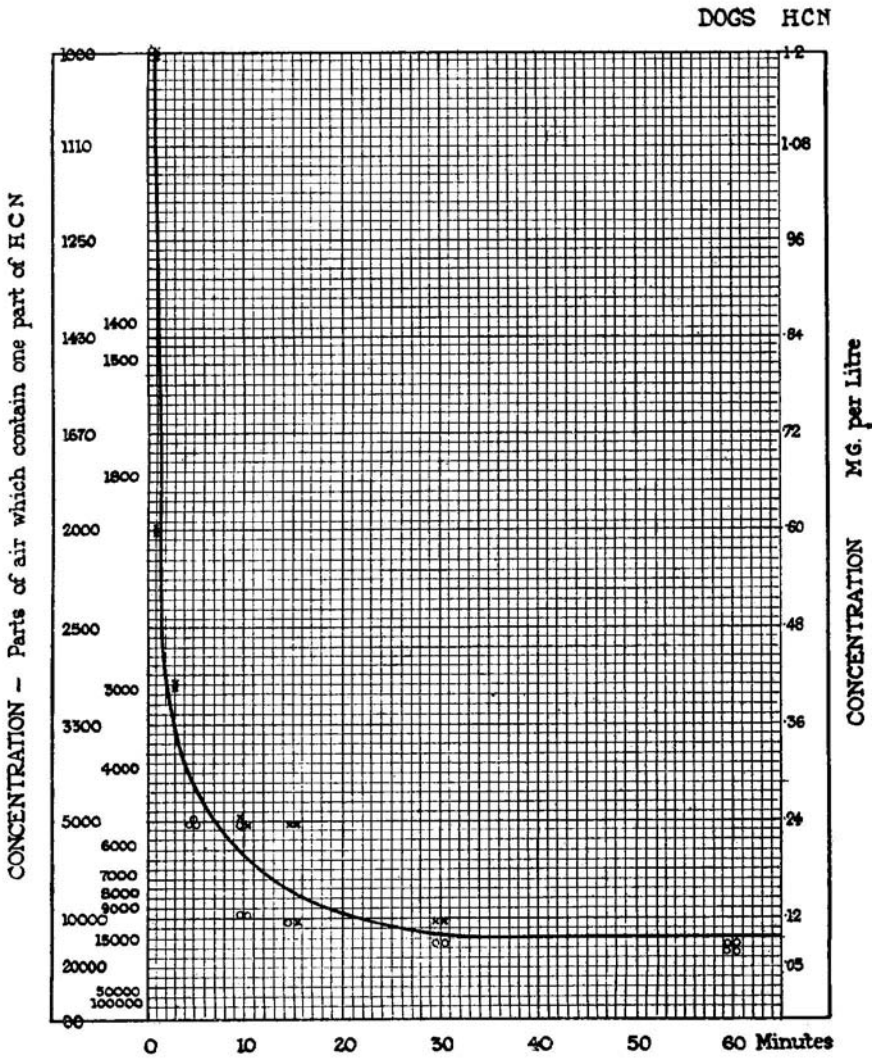


Fig. 6. Shows the prospect of life of dogs when exposed to an atmosphere containing HCN. Scales, etc., as in Fig. 1.

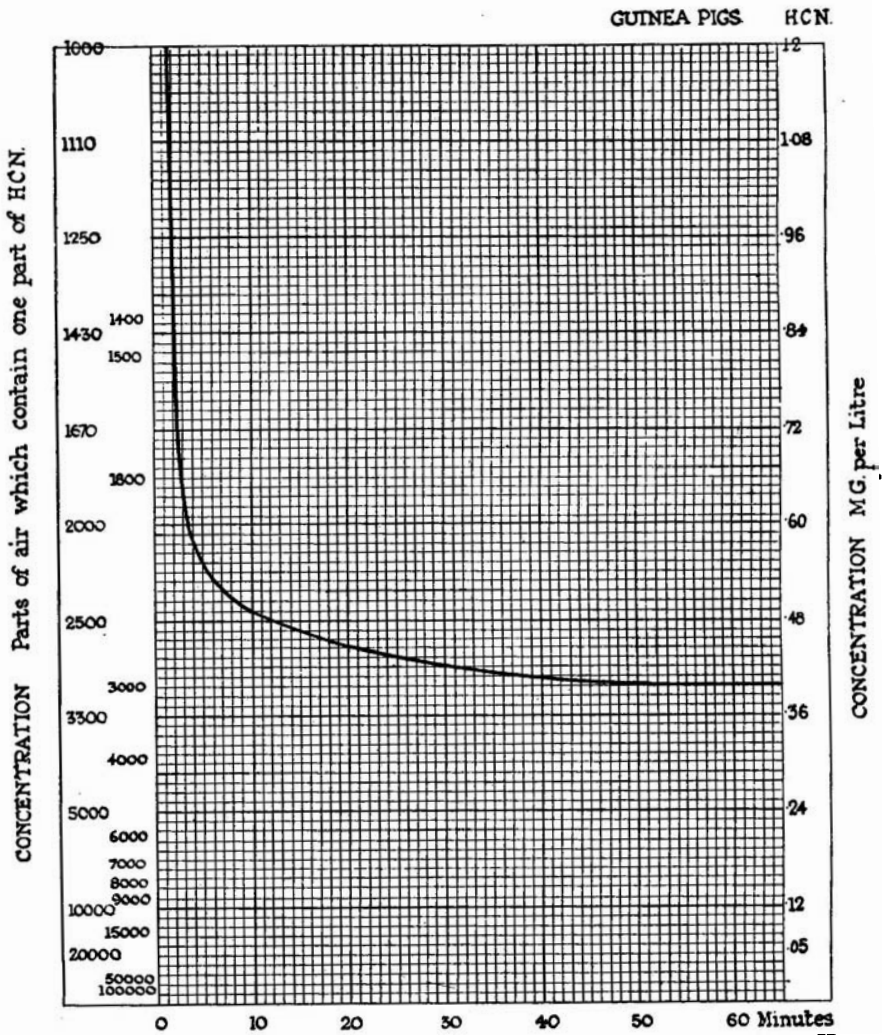


Fig. 7. Shows the prospect of life of guinea-pigs when exposed to an atmosphere of HCN. Scales, etc., as in Fig. 1.

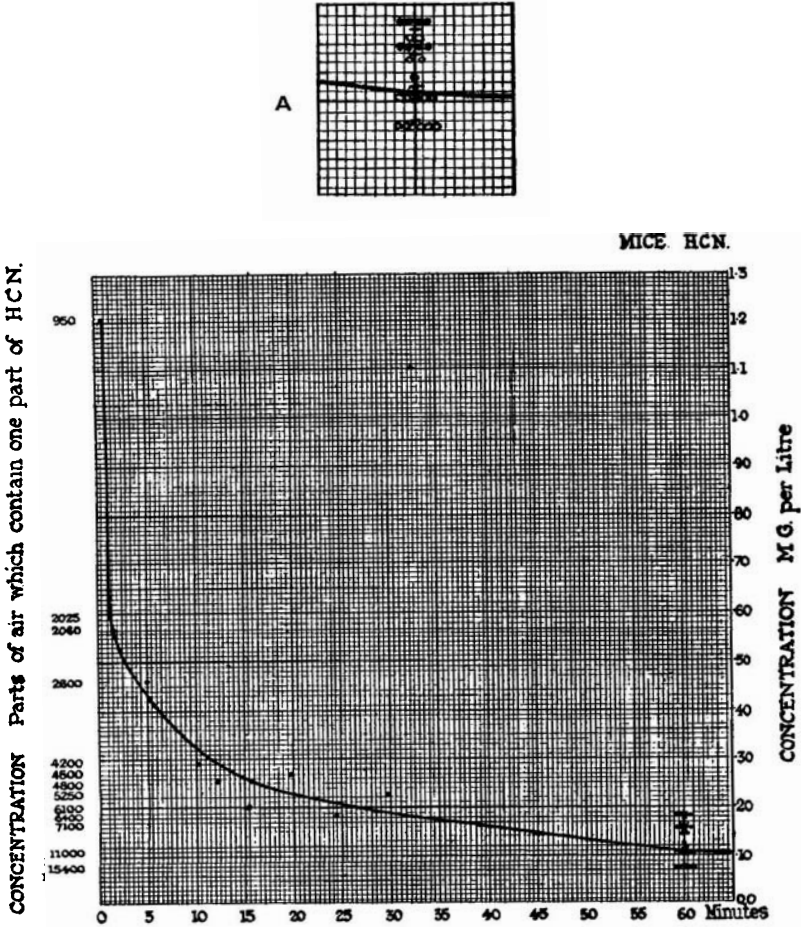
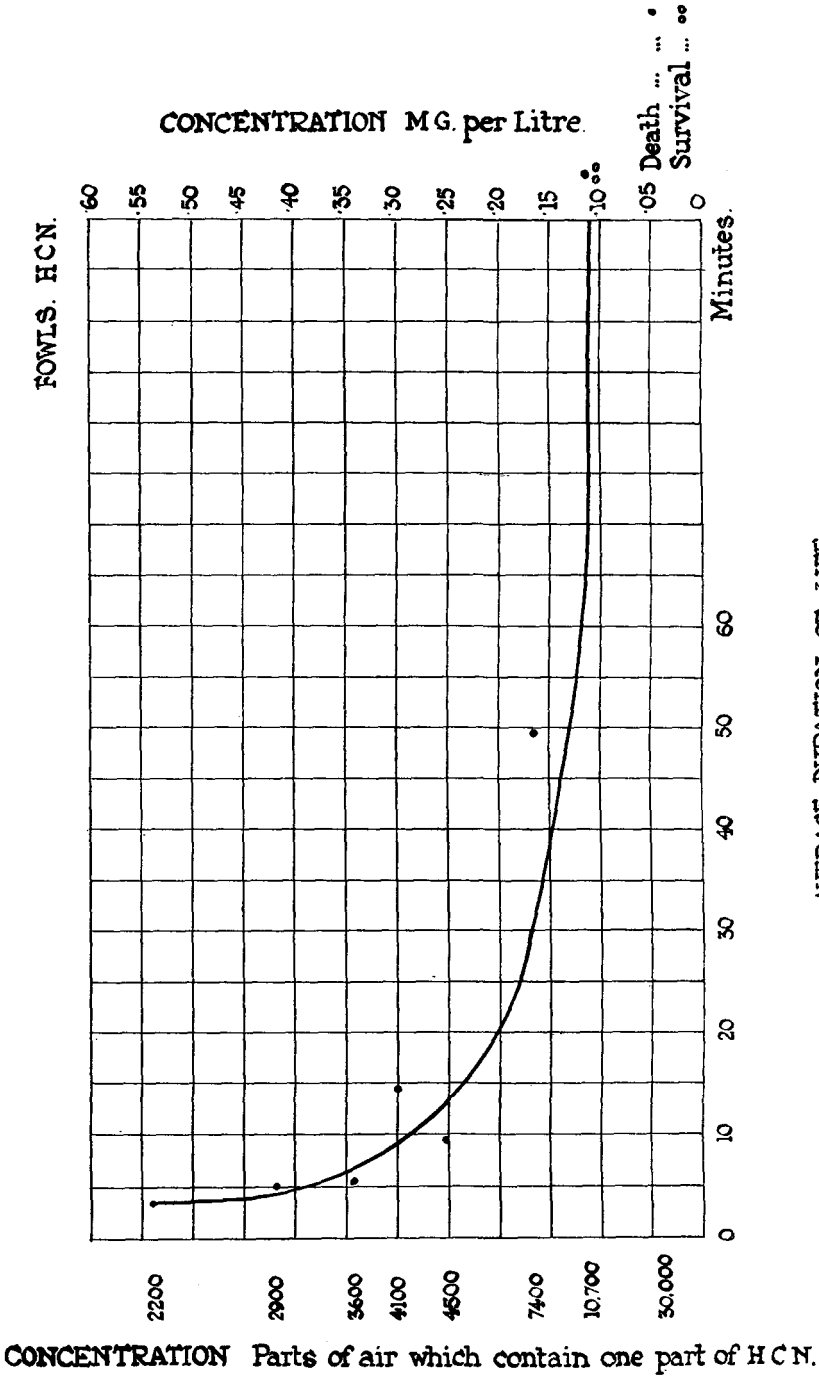


Fig. 8. Shows the prospect of life of mice in an atmosphere of HCN. ● Died. ○ Survived. Scales, etc., as in Fig. 1.

The coarsely grated square A shows details that are obscure in the lower right-hand portion of the figure.

*Hydrocyanic Acid Gas*



**AVERAGE DURATION OF LIFE**  
 Fig. 9. Prospect of life of fowls in atmospheres containing HCN. Scales, etc., as in Fig. 8.

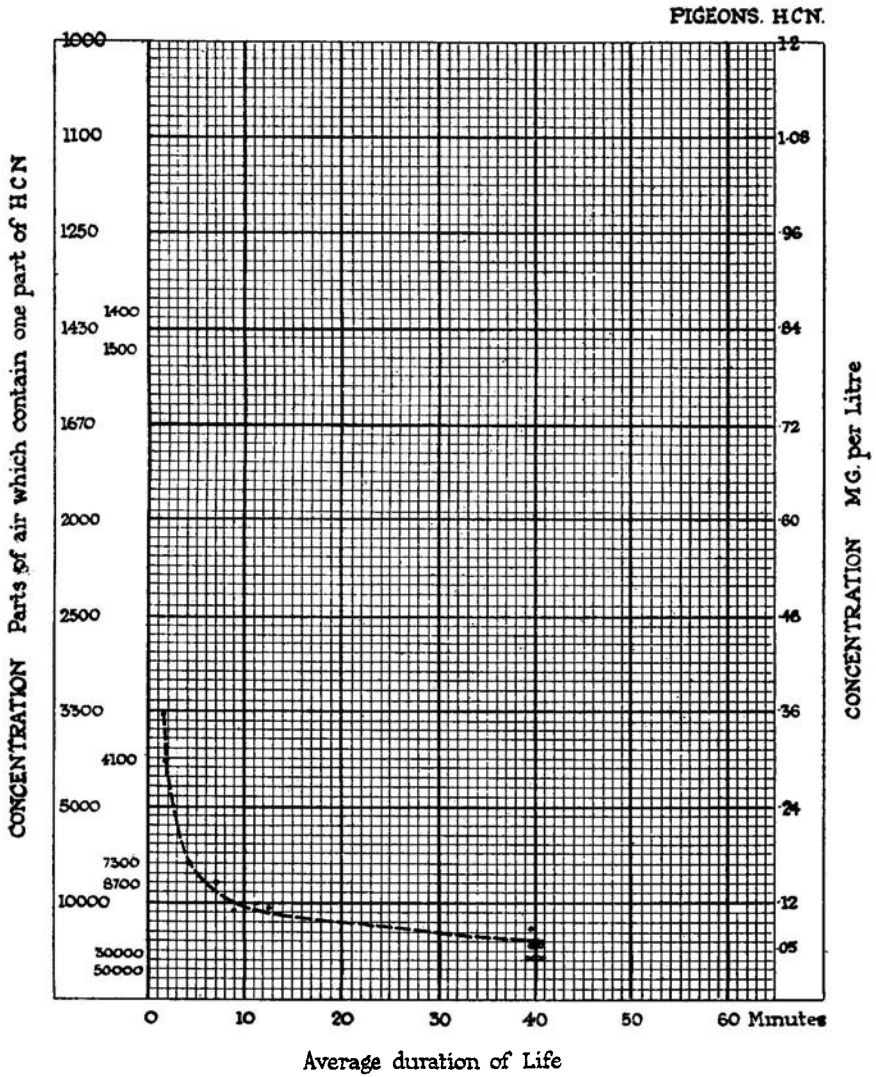


Fig. 10. Prospect of life of pigeons in atmospheres containing HCN. Scales, etc., as in Fig. 8.

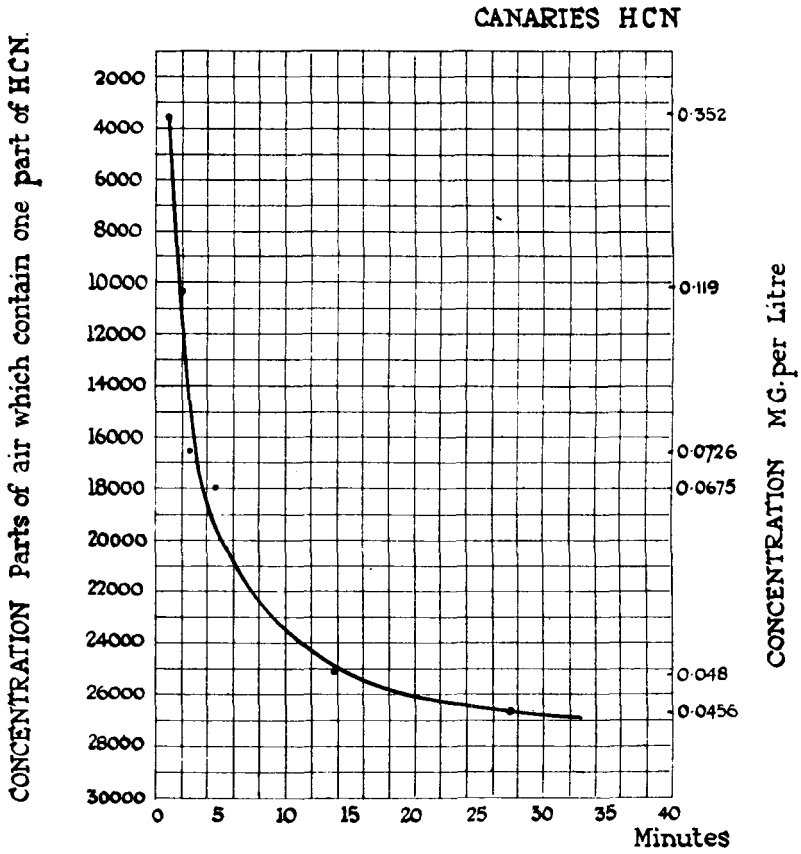


Fig. 11. Prospect of life of canaries in atmospheres containing HCN. Scales, etc., as in Fig. 8.

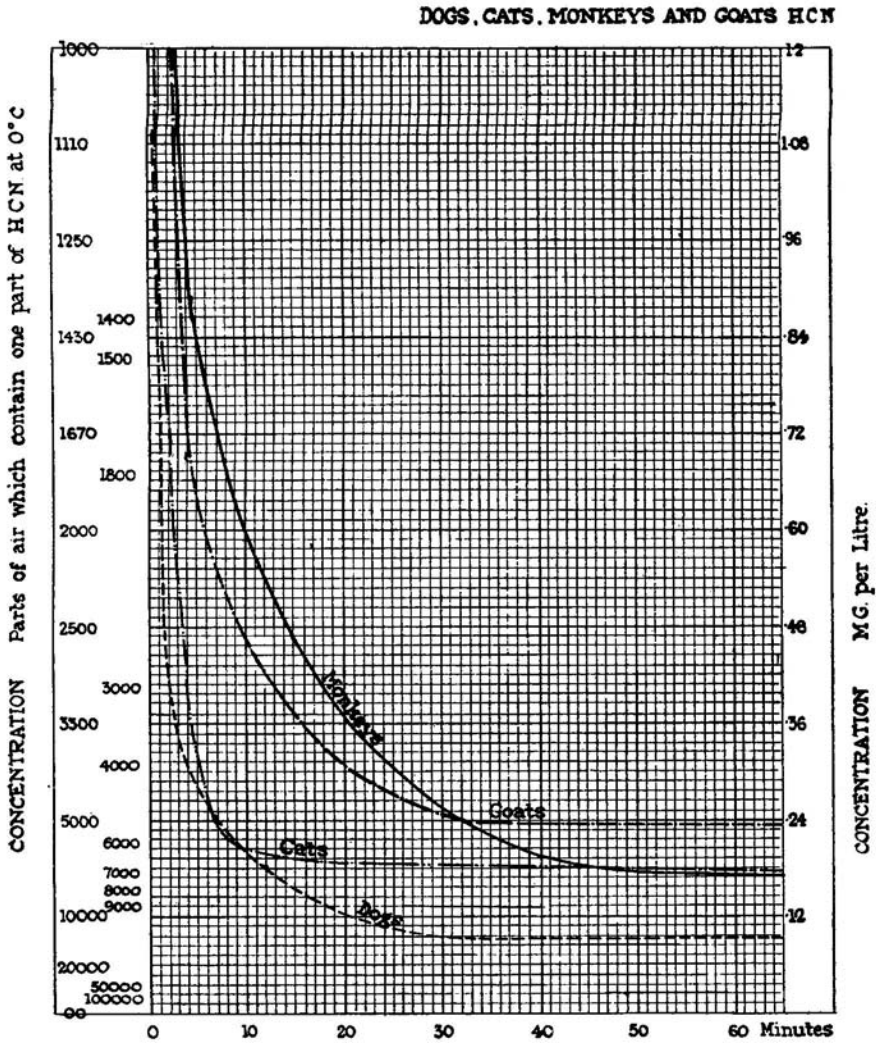
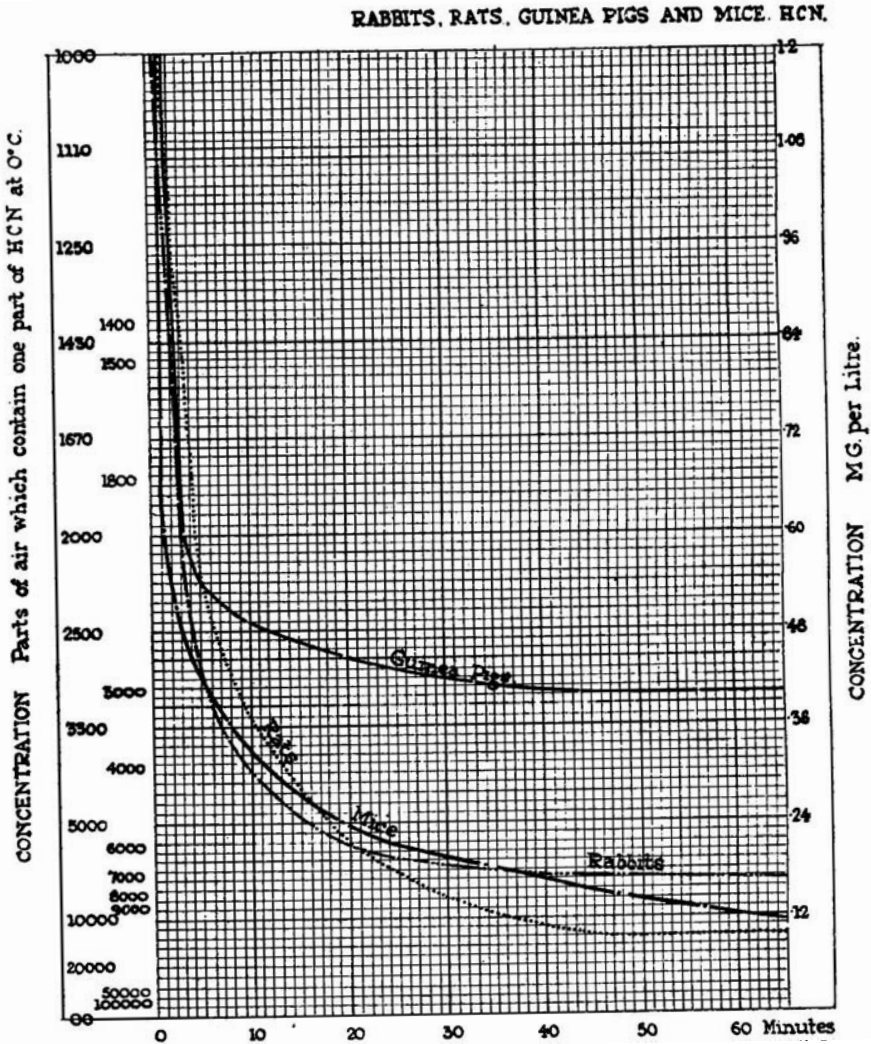


Fig. 12. Shows the curves for the prospect of life given in Figs. 1, 2, 5 and 6, for goats, monkeys, cats and dogs respectively, superposed. Scales, etc., as in Fig. 1.



**Fig. 13.** Shows the curves for the prospect of life given in Figs. 3, 4, 7 and 8, for rabbits, rats, guinea-pigs and mice respectively, superposed. Scales, etc., as in Fig. 1.



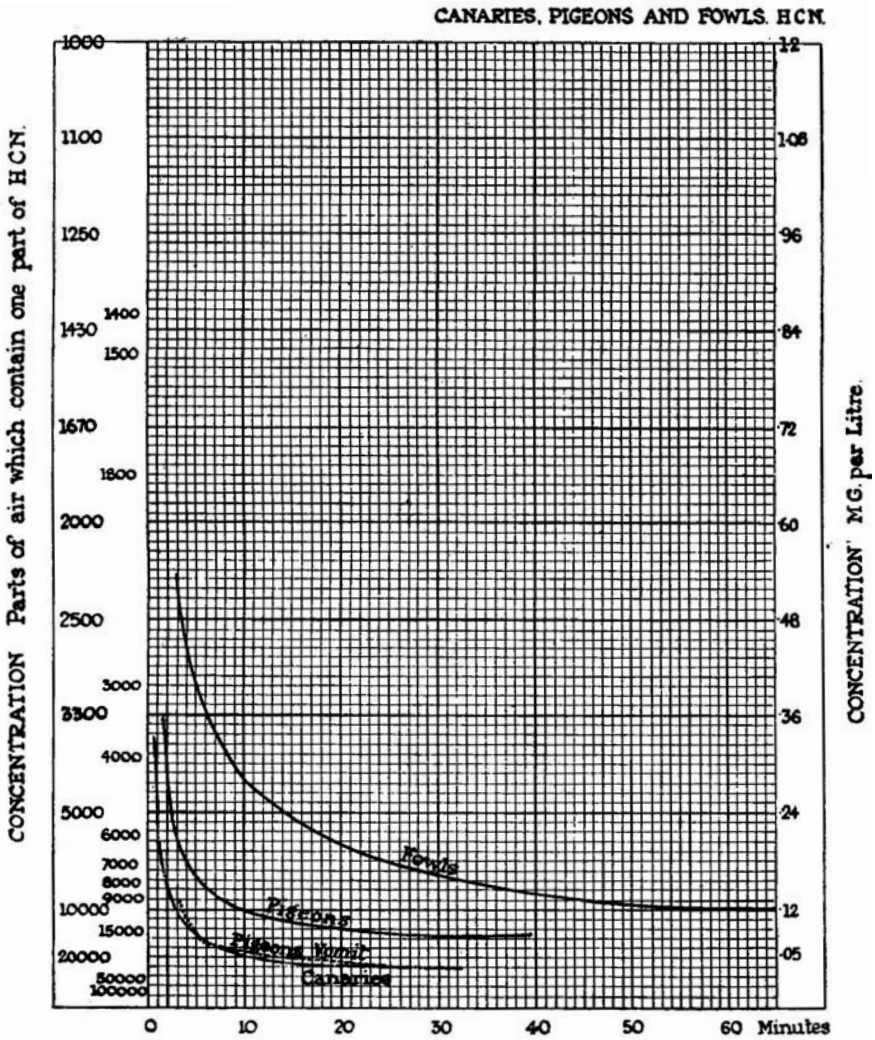


Fig. 14. Shows the curves for the prospect of life, given in Figs. 9, 10 and 11 for fowls, pigeons and canaries respectively, superposed. Scales, etc., as in Fig. 1. Also the times necessary to produce vomiting in pigeons at various concentrations.

Table II. *Animals in order of sensitiveness to HCN.*

Animal	Lethal time of exposure to a concentration of 1.0 mg./litre (mins.)	Animal	Highest approximate concentration which can be breathed indefinitely mg./litre
Dog	0.8	Dog	0.10
Mouse	1.0	Rat	0.10
Cat	1.0	Mouse	0.14
Rabbit	1.0	Rabbit	0.18
Rat	2.0	Monkey	0.18
Guinea-pig	2.0	Cat	0.18
Goat	3.0	Goat	0.24
Monkey	3.5	Guinea-pig	0.40

Table II, the right half, shows also the comparative sensitiveness of the same species as are named in the left half to very low concentrations, the goat being able to tolerate more than twice the concentration which will kill the dog and the guinea-pig four times that which will kill the rat.

The question naturally arises, can any reason be assigned for the difference in susceptibility of different species (1) to weak concentrations; (2) to strong concentrations?

(1) The discussion of weak concentrations is best deferred and is to be found on page 24.

(2) *Strong concentrations.* The case of strong concentrations is in one respect easier than that of weak ones, for it contains one less factor—the rate at which the HCN is destroyed may doubtless be neglected. In the case of carbon monoxide, it is known that if a series of animals of markedly different size are exposed to considerable concentrations of this gas the smaller animals succumb first, because, relatively to their weight, they inhale it and distribute it more rapidly. In a mouse, for instance, carbon monoxide more rapidly attains a lethal concentration in the blood than in a dog, and *a fortiori* than in man. The actual concentration in the blood required to kill the mouse is not smaller than that required to kill a man, in fact it is greater. In very low concentrations, therefore, a mouse might live where a man might die. The present argument, therefore, refers only to concentrations which are in any case lethal, and to the time required in such for a fatality to occur.

Unless there is some reason to the contrary, the whole argument which applies to carbon monoxide might be expected to apply to hydrocyanic acid. The forms of life which pass most air and most blood through their lungs per kg. of animal, per minute, should absorb the gas most rapidly and, other things being equal, succumb soonest. Should the various forms of life not die in the inverse order of their size, when exposed to a given concentration of gas, it can only be, either that their normal rates of respiration and circulation are upset by the gas (a notable instance in point is that of the exposure of rabbits to chloropicrin, the effect of which is to stop their respiration entirely for some minutes), or that the size factor is masked by other and more powerful effects of this gas.

Reference to Table II above shows that the lethal time of exposure to concentrations which kill in a few minutes is not determined primarily by the "size factor." The dog and the goat are not animals of a wholly different order of size, yet the goat will survive more than three times as long as the dog, while the monkey, which again is an animal of about the same size as the dog, will survive four times as long. Yet between the goat and the dog comes a much smaller animal, the rat. The dog and the mouse survive about the same time in high concentrations (0.5–1.0 mg./litre).

The importance of correct ideas on the relation of the "size factor" to the toxicity is very great, for were the size factor the ruling one, it could be taken for granted that man would out-last any of the above forms of life,

and even a likely guess could be made as to the length of time by which he would do so.

The following experiment performed by the Experimental Staff during the Great War illustrates the case of animals of the same order of size, the dog and the goat. The difference in tolerance to HCN of these animals is so great as not to be obscured by the hazards of exposure to gas "in the open." The same difference of sensitiveness between dogs and goats would no doubt be equally apparent in other places even where the gas was distributed somewhat unevenly. The experiment was as follows:

In the open air goats and dogs were exposed to hydrocyanic acid gas in the following way. A number of stations were marked out on the ground; at each station was placed in close juxtaposition a pair of animals, namely one goat and one dog, the animals being selected so that the dog and the goat at any particular station were of much the same size. Commercial hydrocyanic acid gas was then released into the atmosphere from shells, each of which contained about 900 c.c. of the fluid. Since the shells were fired over a short period of time and fell at different distances from the animals, the concentration on the line on which the animals were exposed was somewhat haphazard and uneven. Table III shows the fatality among the dogs and goats respectively. The animals were in no case killed by the shell splinters.

Table III.

	Dogs	Goats
Numbers of animals exposed	7	7
Killed	6	2
Unconscious, but survived	1	0
Affected	7	2

From Table III it is clear that the dogs were much more susceptible than the goats to the HCN vapour.

An experiment in which two dogs and two monkeys were exposed to the same concentration of gas in the gas chamber showed that the monkeys were only commencing to show signs of unsteadiness when the dogs died.

### III. MODE AND SEAT OF ACTION OF HCN VAPOUR.

The effects of hydrocyanic acid, when given by the mouth or injected, are described in all textbooks of pharmacology. In particular the reader is referred to a paper on the subject by Prof. C. Lovatt Evans (1919), the gist of this paper is summarised by Vedder (1925). The general action of HCN in the concentrations under consideration is not, as was formerly supposed, that of functionally destroying the haemoglobin by the formation of cyan-haemoglobin. As Evans showed: "the bright colour of the blood in poisoning is due to the fact that the venous blood contains an excess of oxygen over the normal. In other words the tissues have been unable to remove the oxygen from the blood."

More recently a great volume of work has been carried out by Warburg

(1923, 1928) and his associates, and by Keilin (1925, 1929), showing that the HCN acts on the intercellular enzymes of the body, more especially that known as the cytochrome oxidase. These enzymes are responsible for the oxidative life of the tissues, and are reduced to impotence by prussic acid.

The actual cause of death when small doses of prussic acid are taken is paralysis of the respiratory centre. The acid first stimulates the centre, and then completely inhibits. The heart beat continues after the respiration has ceased, and the heart ultimately fails, partly on account of the direct action of the acid, but partly also on account of the asphyxia secondary to cessation of respiration.

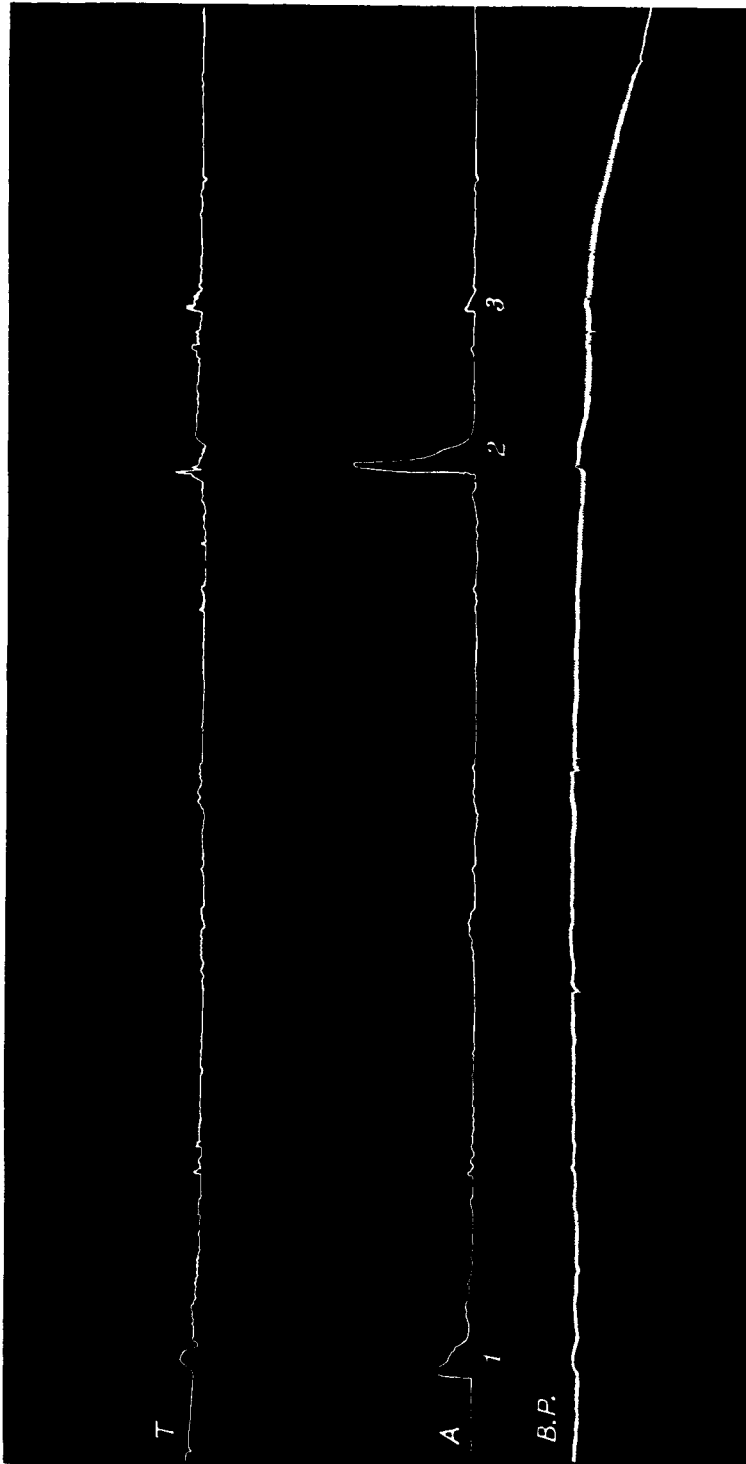
This sequence of events appears to be true also of the prussic acid when inhaled.

Fig. 15 shows three tracings, taken by H. Taylor (1931), *A* and *T* of the movements of the chest of a cat at the moment when life is becoming extinct. The larger oscillations are due to respiration. The third tracing *B.P.* is the arterial pressure, the smaller oscillations on which are evidence of heart beats. The tracings *A* and *T* were taken by Lumsden's method (1923), glycerine tambours having been bandaged to the abdominal and thoracic walls respectively. The alteration in pressure in the tambours were communicated to the recording tambours. The abdominal record gives an indication of the movements of the diaphragm.

What difference can there be between the respiratory centre of, say, a goat and that of a dog which will render the latter more susceptible to hydrocyanic acid than the former? About the dog and the goat in this connection we have no definite information, but experiments performed by H. Taylor on the cat and the rabbit respectively yield instructive results.

The cat, or the rabbit, is lightly anaesthetised, a trachea tube is inserted, and the total ventilation of each may be measured in the following way. The animal is placed in an airtight box (Fig. 16). In the walls of the box are two holes each fitted with a rubber cork. Through the rubber corks pass glass tubes *B'* and *C* respectively. The inner orifice of the glass tube in hole *C* is attached to the trachea tube of the animal; the outer orifice communicates with the toxic atmosphere. The tube *B'* is open inside to the air in the box, whilst its outer orifice is connected by rubber tubing with the orifice *B* of a recording spirometer *A*. Every inspiration of the cat displaces a corresponding quantity of air into the spirometer, which air returns to the box during expiration.

Measurements made in this way of the actual quantity of air inhaled show a remarkable difference between the cat and the rabbit. When HCN is administered in the air the quantity of air which the rabbit inhales per minute is at no stage appreciably increased over and above the value which is obtained when the animal was breathing pure air. In the case of the cat, however, there is at first a great increase in the total ventilation. These facts are illustrated in Figs. 17 and 18, which are records of typical experiments.



**Fig. 15.** Tracings *T* and *A* record movements of thoracic and abdominal walls respectively during the last three respirations 1, 2 and 3, given by a cat. *B.P.* = tracing of arterial pressure.

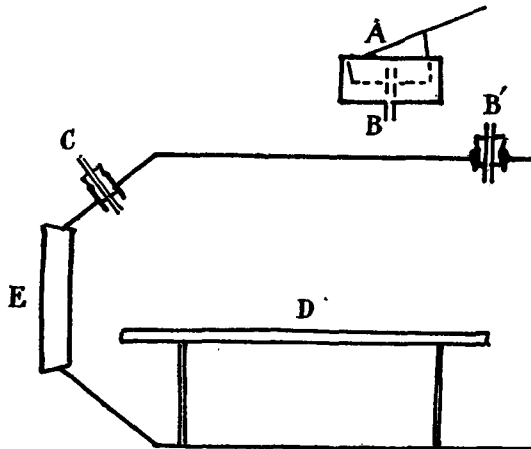


Fig. 16. Apparatus used by H. Taylor for recording the total ventilation and also the rate and depth of respiration. *A*, spirometer. *B* and *B'*, orifices for the attachment of the spirometer to the pneumatic chamber. *C*, orifice leading from the trachea tube to the outer atmosphere. *D*, table to which the anaesthetised animal is attached. *E*, wooden stopper, rendered airtight. The chamber is made from an oil tin. Scale one-fifth of actual linear dimensions.

CAT

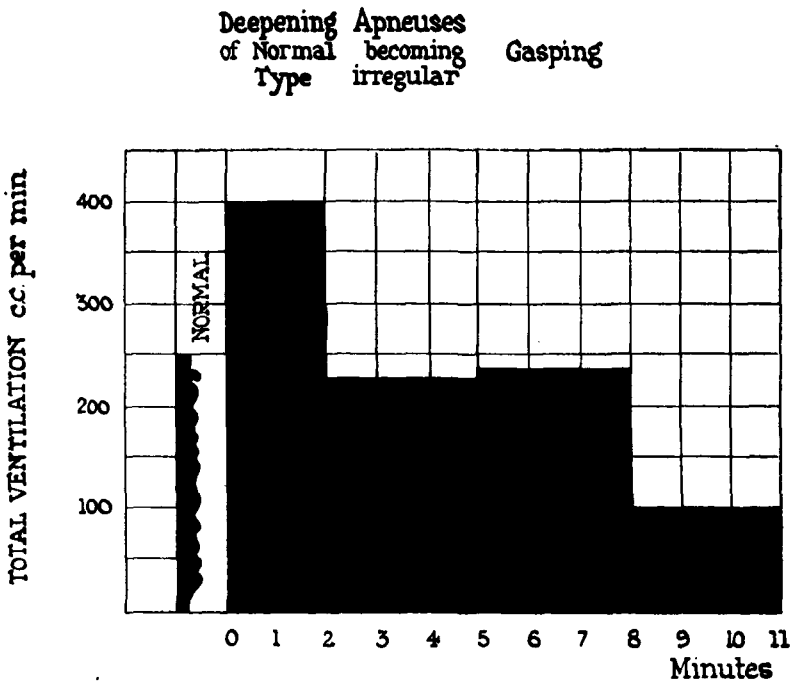


Fig. 17. Variations in the total ventilation of the cat when breathing an atmosphere containing 0.36 gm. of HCN per cubic m. of air. Zero time = commencement of dose.

The essential data in Figs. 16 and 17 may be tabulated as follows:

Table IV.

	Total ventilation before adminis- tration of HCN (c.c.)	Concentration of HCN in air administered in mg./litre	Period from commencement of HCN inhalation till death (min.)	Total volume of air inhaled in that period (c.c.)	Total quantity of HCN inhaled (mg.)
Rabbit	252	0.50	15	1902	0.95
Cat	252	0.36	11	2547	0.92

## RABBIT

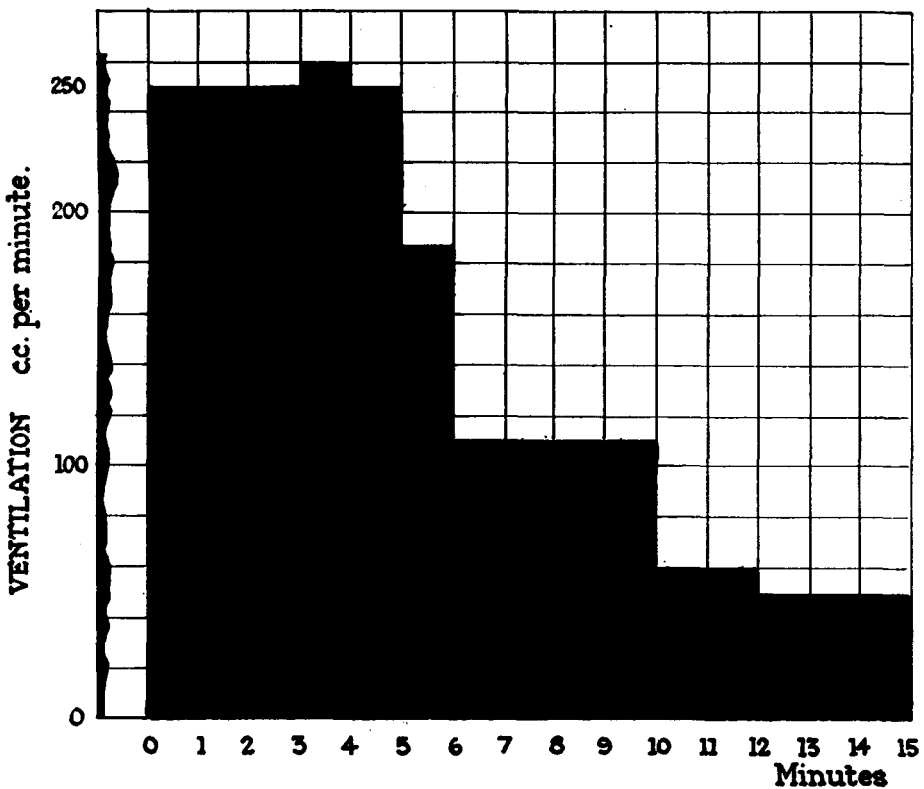


Fig. 18. Variations in the total ventilation of the rabbit when breathing an atmosphere of 0.51 gm. of HCN per cubic m. of air.

In spite, therefore, of the facts (1) that the initial ventilation was the same in each case; (2) that the concentration of HCN in the air breathed by the cat was less than in that breathed by the rabbit; and (3) that the cat died sooner than the rabbit, the actual quantity of HCN inhaled by the cat was approximately the same as that inhaled by the rabbit. The lethal dose of NaCN for a cat is given by Evans (1919) as 1.3 mg./kilogram.

At present it is not possible to say that the specific power of hydrocyanic acid to increase the total ventilation is the only factor in determining the specific toxicity of the gas, but clearly it is an important factor.

#### IV. THE SPECIFIC ACTION OF HYDROCYANIC ACID INHALED IN LOW CONCENTRATIONS.

About the factors which dictate the concentrations of hydrocyanic acid which are just tolerable to various forms of life, little can be said. It might be supposed here also that the size of the animal might be the determining factor, the rate at which the gas is inhaled being proportionate to the square of its linear proportions, and the rate at which it is destroyed being proportionate to the mass of the animal. In that case the largest animals would best tolerate the gas. That is not far from being the case, but exceptions exist, and here again the dog forms the principal anomalous case. It must be assumed that one or more of the following factors are at work: (1) that the dog inhales greater quantities of air than would be expected from its size; (2) that its tissues, compared with those of other animals, destroy the gas slowly; (3) that a less concentration in the blood will affect its central respiratory mechanism.

The animal most tolerant of small concentrations of HCN is the guinea-pig.

#### V. THE TOXICITY OF HCN TO MAN WHEN INHALED.

The question of where man stands in relation to the animals is most important. Clearly it is very difficult to obtain exact information on this subject, for when fatalities are concerned the concentrations which produce them are not known.

The experiment about to be described shows, however, that man is not very susceptible. It took place in the airtight chamber already described, the human subject was about 45 years of age, and weighed about 70 kg.

One human being and one dog (about 12 kg.)<sup>1</sup> were exposed simultaneously, without protection, to an atmosphere containing a nominal concentration of 1/1600 hydrocyanic acid, the actual concentration being probably between that and 1/2000. The dog was placed in one corner of the chamber, the man in the corner diagonally opposite to him, so that they faced one another. The utmost care was taken lest, if the dog succumbed first it should not be because its respiration was stimulated by a greater degree of muscular activity, therefore each movement made by the dog was followed by an imitative movement on the part of the man, so that the degree of activity of the two might be as nearly as possible the same. This procedure was followed up to the point at which the dog became unconscious. After that no effort was made by the man to imitate the muscular spasms which form so conspicuous a feature of the later stages of cyanide poisoning. The experiment ran the

<sup>1</sup> The weight of this dog is not recorded and the above figure is guessed from memory of its general appearance. It is intended only to give an idea of the sort of sized dog used.



course as shown in the following notes which were taken by the man as the experiment proceeded.

Table V.

Time from zero	Dog	Man
50 sec.	Became unsteady	—
1 min. 15 sec.	On floor unconscious	—
1 min. 30 sec.	Crying sounds and tetanic convulsions sufficiently established to render it probable that animal was in extremis	—
1 min. 31 sec.	—	Came out of chamber and put on respirator having felt no symptoms. No apparent dyspnoea
1 min. 33 sec.	Respiration apparently* ceased, animal believed to be dead, was pulled out by lead	Re-entered chamber in respirator for purpose of pulling out dog. Having done this he remained outside
5 min.	—	Momentary feeling of nausea
10 min.	—	Attention difficult to concentrate in close conversation

\* Although the corpse was set aside for burial about 6.30 p.m., the dog did in point of fact recover, and was found walking about next morning. It showed no further symptoms.

A report by S. H. Katz and E. S. Longfellow from the American Bureau of Mines issued in July 1923 states: "Men employed in fumigation with HCN have been tested while at rest in 250 parts per million of air for 2 minutes and in 350 parts per million for 1½ minutes, but felt no dizziness, although possibly on exertion they might have done so. In experiments during the war men have been exposed to 500 parts per million for about a minute without injury<sup>1</sup>. Hydrocyanic acid gas was formerly considered one of the deadliest gases in minute concentrations, but later experience, especially in the war, has shown that man is more resistant than some other forms of life—[Lehmann, *Tabelle der kleinsten Mengen, welche allenfalls ertragen werden*, in book by Kobert, *Kompendium der praktischen Toxikologie zum Gebrauche für Aerzte, Studierende und Medizinalbeamte*. Stuttgart, p. 45] whereas recently Kohn-Abrest [*Notice toxicologique sur les gas. Annales des Falsifications*, 8, pp. 215–39] determined that 1000 parts per million are impossible to breathe for many minutes."

#### VI. THE CONCENTRATION NECESSARY TO PRODUCE UNCONSCIOUSNESS.

The relation of the time necessary to produce unconsciousness to that necessary to produce death is of much interest, unless either the concentration is dissipated or the man rescued; once he becomes unconscious he must go on breathing the gas and therefore the relation of concentration to time necessary to produce unconsciousness is potentially that which will produce death unless the concentration is sublethal. Such information as is available is chiefly gleaned from experiments on goats. Unconsciousness is, perhaps, the

<sup>1</sup> It is not clear whether the last statement refers to the experiment described above, and which was communicated to the American authorities, or to an independent experiment in America in which the figures were of a similar order.

*Hydrocyanic Acid Gas*

wrong word, more correctly, the time observed was that at which the animal fell. Table VI gives the data which were obtained during the Great War:

Table VI. *Goats.*

Concentration	Produced unconsciousness in (min.)	Produced death in (min.)
1 in 1000 (1.2 mg./litre)	1	3
1 in 2000 (0.6 mg./litre)	2	10
1 in 3000 (0.4 mg./litre)	6	16
1 in 5000 (0.24 mg./litre)	12	23

**HCN. GOATS.**

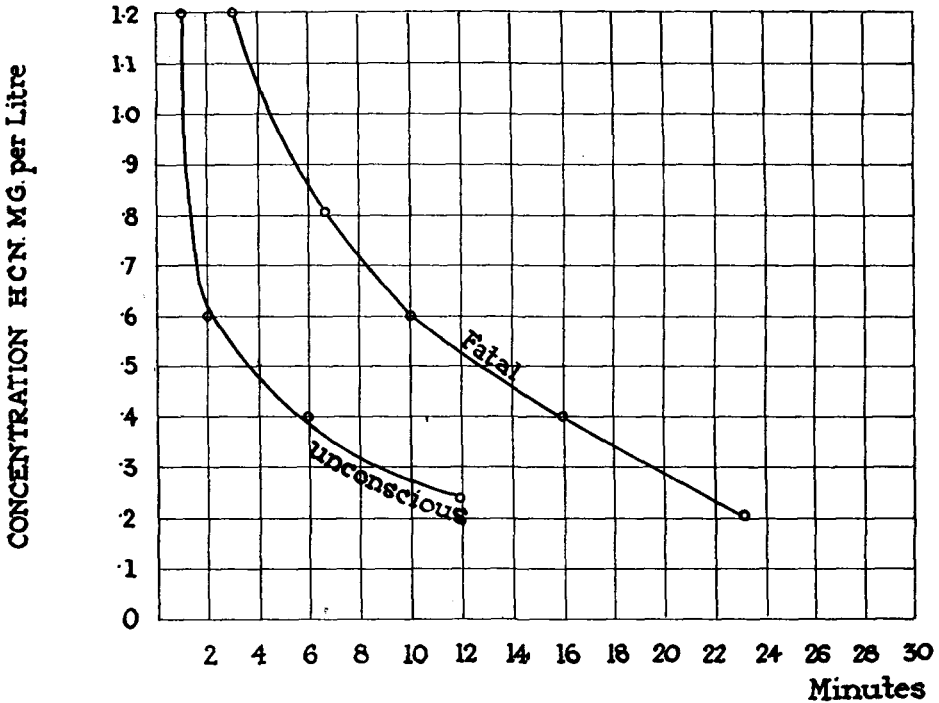


Fig. 19. Curves showing the concentration (ordinate) which if breathed for a given time (abscissa) will produce (a) death, (b) unconsciousness, in 50 per cent. of the cases in goats.

In general, therefore, the time of exposure sufficient for collapse is about one-third of the fatal period of exposure. The rates of the times of exposure necessary to produce collapse and death respectively is not a constant one, and is shown in Fig. 19.

The following figures are quoted from *Noxious Gases* by Henderson and Haggard (1927):

Table VII.

	Parts of air per 1 part of HCN
Slight symptoms after several hours exposure	50,000
Maximum that can be inhaled indefinitely without serious disturbance	20,000-17,000
Dangerous in 30 minutes to 1 hour	7,000- 8,000
Rapidly fatal	3000

## VII. GENERAL COMPARISON BETWEEN MAMMALS AND BIRDS.

Curves have been determined upon canaries, pigeons and fowls. The creatures are of the same order of weight as mice, rats and rabbits respectively. Of the curve for fowls there is nothing special to be said, but one of the most striking things about HCN is its high toxicity for canaries and pigeons. It is about twice as toxic to the former as to the latter. Taking the extreme types, canaries will die in 1 in 10,000 parts of HCN in about 2 minutes; monkeys will withstand that concentration indefinitely. In twice that concentration, 1 in 5000, canaries will die in 1 minute, monkeys in about 25 minutes.

The extreme susceptibility of canaries to HCN makes them valuable as indicators of lethal concentrations of the gas in cases where a chemical indicator is not available. Pigeons, moreover, are no less useful than canaries, for though the concentration lethal to the pigeon is almost twice that lethal to the canary, the pigeon vomits at about the concentration at which the canary dies.

## VIII. THE CONCENTRATION NECESSARY TO MAKE PIGEONS VOMIT.

These may be read from Fig. 14.

Why canaries and pigeons should be so much more susceptible than mice and rats respectively we do not know. Little definite knowledge exists about respiration in birds; it is, of course, of quite a different nature from that of mammals. The air is said to be drawn through the lungs rather than in and out of them, and in this connection we do not know even in mammals what proportion of the HCN in the inspired air is absorbed. One possible explana-

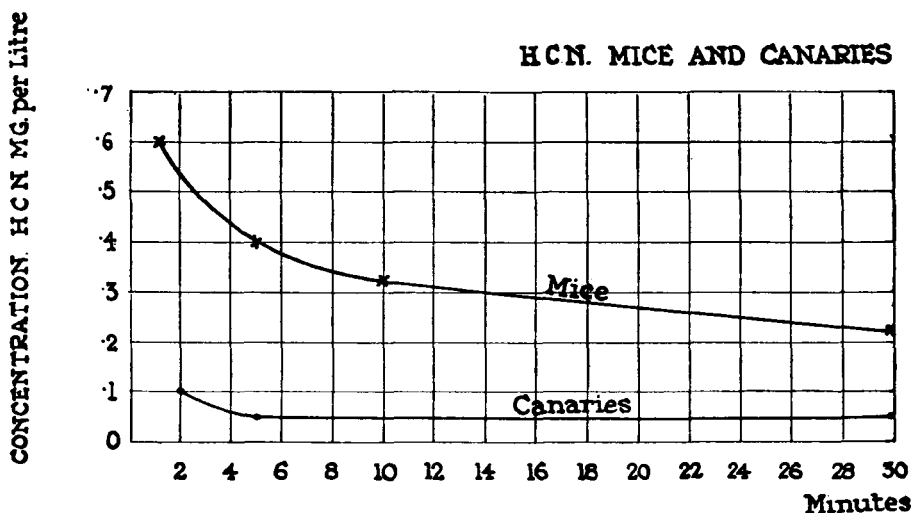


Fig. 20. Comparison of curves relating the fatal concentration to the time for which the gas is inhaled in the case of mice and canaries respectively.

*Hydrocyanic Acid Gas*

tion has been tested and appears not to be the true one, namely, that birds having a higher metabolism have a much greater total ventilation.

H. Taylor has devised a method for the measurement of the total ventilation which appears to give approximately correct results, it assumes that the

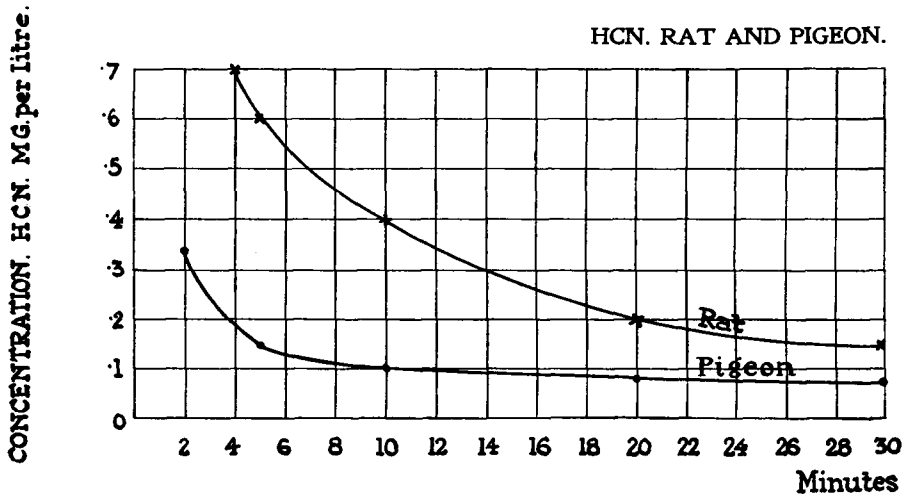


Fig. 21. Comparison of curves relating the fatal concentration to the time for which the gas is inhaled in the case of rats and pigeons respectively.

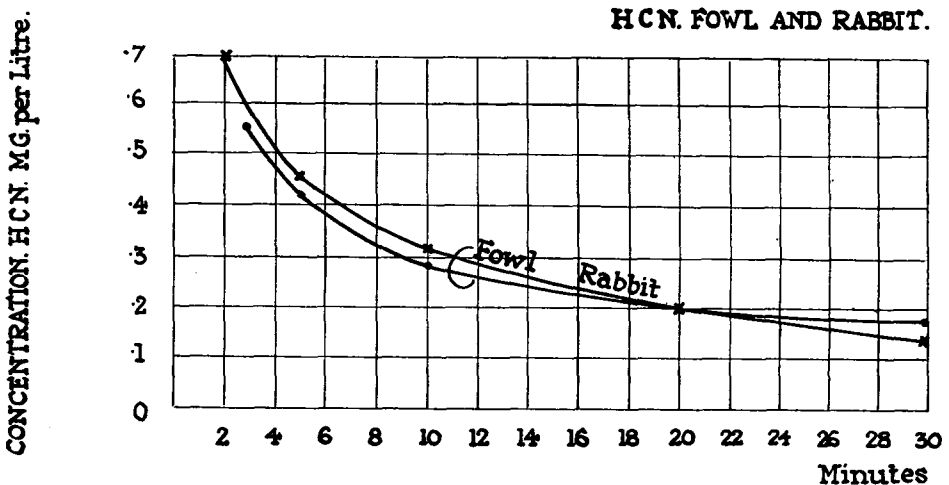


Fig. 22. Comparison of curves relating the fatal concentration to the time for which the gas is inhaled in the case of fowls and rabbits respectively.

expired air is 92 per cent. saturated with water vapour. The animal is placed in a dry chamber, through which a measured current of dry air is passed. The water in the effluent air is collected and estimated, and precautions being taken that the air receives moisture from no other source than the breath,

the volume of the expired air is ascertained. The following data are given by Taylor:

Table VIII.

Animal	No. of experiments	Weight (gm.)	Relation of surface to $W^{\frac{2}{3}}$	Respiration per kg. per min.	Respiration per sq. cm. per min.
Rabbit	15	1256 ± 184	× 12.9	393 ± 47	0.33 ± 0.04
Guinea-pig	27	519 ± 148	× 8.5	615 ± 175	0.61 ± 0.43
Rat	16	205 ±	× 9.1	1561 ± 273	1.02 ± 0.18
Pigeon	9	421 ± 16	× 10.45	1173 ± 188	0.88 ± 0.14
Mouse	17	31 ± 2	× 11.4	5097 ± 1105	1.41 ± 0.29
Canary	17	16 ± 1	10 × 45	5611 ± 1099	1.37 ± 0.27

The rat and the pigeon appear to have much the same total ventilation per sq. cm. of body surface as one another. So also do the mouse and the canary. It is true that the canaries on the average were only half the weight of the mice, but, on the other hand, the pigeons were twice the weight of the rats.

#### IX. INDICATORS.

There is no simple chemical indicator which is affected by hydrocyanic acid which can be trusted to reveal the presence of the gas in dilutions which fall short of those affecting man.

A rather complicated indicator consisting of three sets of test papers, standard sets and tints, a stop-watch, etc. is described by Katz and Longfellow (1923). This professes to detect 1 part in 40,000 of HCN in air.

For the purposes of fumigation it is possible to mix into the prussic acid small quantities of highly irritant gases, which will reveal the presence of the hydrocyanic acid even when the latter is in innocuous concentrations.

The experiments cited above show that many animals, notably dogs, rats, mice, pigeons and canaries, are overcome by this gas before man. In fact, almost any smaller animal is so overcome. Rats and mice may be available, but in their use this caution should be given. A man going into a lethal concentration is taking exercise, at least he is walking, and in addition he may easily be carrying a heavy burden of some kind. Therefore, the margin of safety between the lethal dose for man and that for a mouse or a rat in a cage is by no means so great as might appear from a consideration of the experiment described in Table V.

The dog allows of a safer margin, for in addition to being the most sensitive of the quadrupeds which have been studied, he can be made to walk with the man, and the factor of exercise to that extent eliminated. But undoubtedly by reason of their extreme sensitiveness the best indicators are birds. Two of the most readily available serve excellently for this purpose, the canary and the pigeon. The concentrations at which the pigeon will vomit, or the canary will die, are approximately the same, and are over short periods of time, say up to ten minutes, negligible as compared with the concentration which would affect man.

The subject of the experiment described in Table V was inhaling perhaps

10 litres per minute of gas containing 0.6–0.7 mg./litre of HCN; in 1 minute and 35 seconds he will have inhaled say 10 mg. of the gas. To inhale the same quantity of HCN (which is known to be harmless) the man under the circumstances of the experiment would require 10 minutes if the concentration were 0.1 mg. per litre. In this concentration the canary would be dead in about 2 minutes, in which time the pigeon also would be vomiting.

Moreover, the man has in his favour the extra margin obtained by the oxidation of the gas in his tissues, so that the content of HCN in his blood would be by no means so high if he inhaled 1 mg. of HCN in  $1\frac{1}{2}$  minutes as if he took 10 minutes for its inhalation. On the other hand, if the man was so far exerting himself as to be inhaling 50 litres of air per minute (the maximum possible to most men being of the order of 100 litres per minute), the picture would alter, and the value of the bird as an indicator would be reduced.

It should, therefore, be emphasised that persons entering suspect atmospheres should not indulge in greater exertion than is necessary. They should not be breathing heavily.

#### X. TREATMENT.

The possibilities of treatment are:

- (1) Artificial respiration.
- (2) The administration of materials calculated to “kill” the HCN in the body. These may be considered either (a) as prophylactic measures, (b) as remedial measures.

##### (a) *Efficacy of artificial respiration.*

Artificial respiration is certainly useful, and should be employed.

Whilst permanent lesions of the brain are believed to have been found in certain cases, the general trend of knowledge with regard to HCN poisoning is like that of ether or alcohol; the effect is reversible, and if life can be maintained until the lethal concentration has been dispelled the machinery of the body is not impaired, it is merely temporarily brought to a standstill.

The phrase used above “if life can be maintained” is advisedly a loose one. Closer enquiry shows that the impairment of the vital process consists in an incapacity on the part of the tissue ferments, responsible for the fundamental oxidation processes of life, to take up oxygen and build the oxygen into living material. The essential spot at which this disability spells fatality is the living material of the cells in the brain which performs the function of respiration. This blocking of the oxidative enzyme machinery is not diminished by the accumulation of oxygen, and therefore no benefit on this count can be hoped for, from artificial respiration. On the other hand, if all the other mechanisms of the body can be preserved unimpaired till the oxidative enzymes are freed from HCN, the functions of the body will become re-established. The fate of the animal is staked upon a race between the onset of incidental degradation of the machinery of the body, and the dissipation

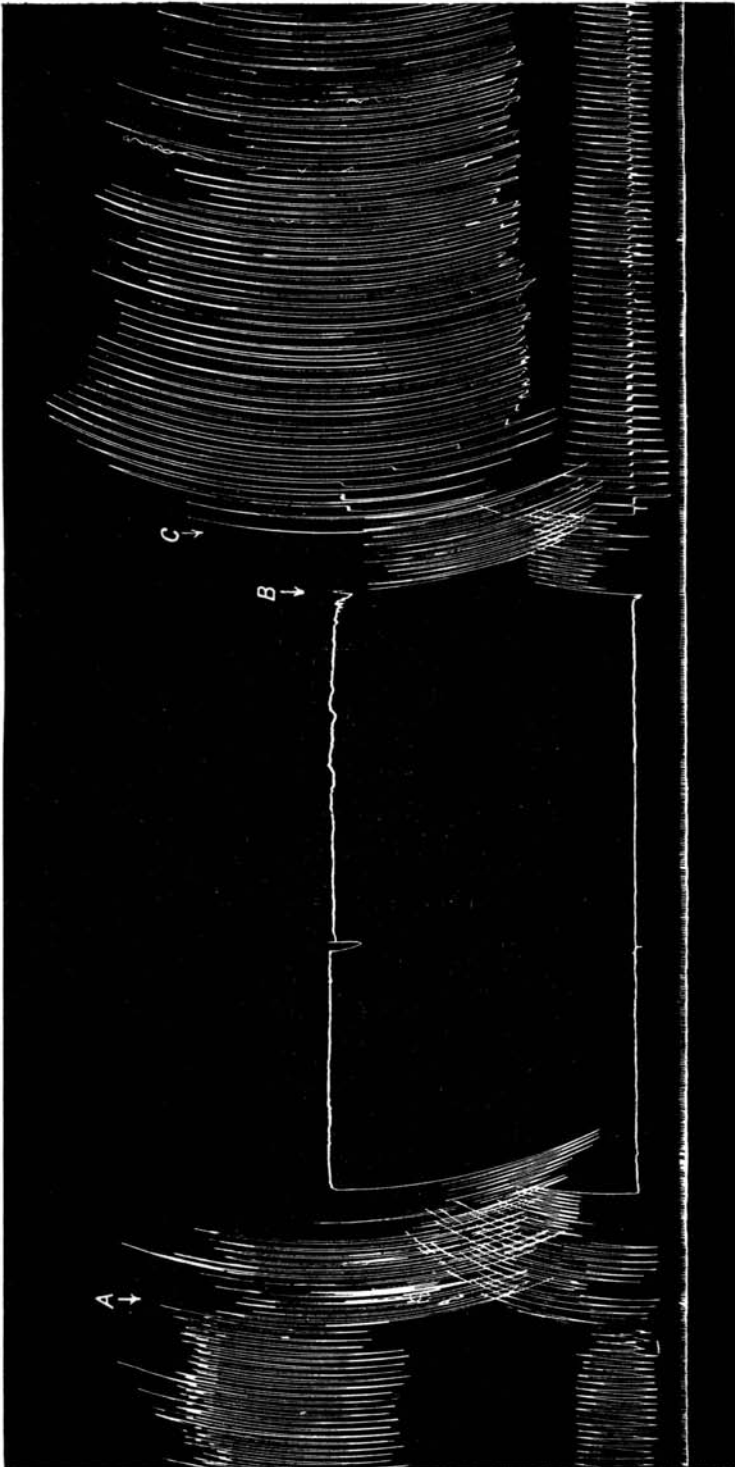


Fig. 23. Record of respiration of the rabbit. Time = seconds (for explanation, see text p. 32).

or "destruction" of HCN. The terms ( $\alpha$ ) "dissipation," and ( $\beta$ ) "destruction," suggests the two lines along which artificial respiration may be useful.

( $\alpha$ ) *Dissipation*. During artificial respiration HCN imparts its odour to the expired air, from which it may be inferred that the concentration of the gas in the blood is reduced, HCN being given off in the air.

( $\beta$ ) *Destruction*. Hydrocyanic acid is destroyed in the tissues. This destruction is probably a change to sulphocyanide and oxidation, yet it does not apparently depend upon the type of enzyme action which HCN destroys. Therefore, if HCN and oxygen can be kept circulating in the body the HCN will be gradually destroyed, and the velocity of this destruction may depend upon the concentration of the oxygen present, following the general law of mass action. Therefore, while no quite definite statement can be made, it seems not unlikely that artificial respiration with oxygen is more desirable than artificial respiration with air.

The upper tracing shown in Fig. 23 is that of a lead attached to a strip of diaphragm muscle in the rabbit (Head's method), and therefore registers the movement of one of the respiratory muscles. The lower tracing shows one of alteration of pressure in the trachea. When the animal inspires this tracing rises, but when on the other hand the lung is artificially inflated, the tracing falls. Reading from left to right, at the commencement of the tracing, the animal was breathing an atmosphere containing HCN at the dictate of its respiratory centre. At *A* artificial respiration was commenced, and the lung was inflated with the same atmosphere, but the total ventilation was considerably increased with the result that the rabbit ceased breathing, the artificial respiration was stopped, and had no further steps been taken the animal would probably not have again respired; but at *B* resort was had to artificial respiration of cyanide-free air; the respiratory centre woke up at *C*, and the animal was restored; this procedure was repeated several times on the animal in question.

(*b*) *Administration of glucose.*

Violle (1926) and Forst (1928) have advocated the injection of glucose on the ground that HCN will react with the glucose forming cyanohydrin, which undergoes hydrolysis to form a harmless compound. The merits of glucose have been denied by Hynd (1927) and Heymans and Soenen (1927). Taylor (1930) has repeated both the experiments of Forst and those of Violle.

Forst's method consisted in the injection of glucose previously to the injection of cyanide. As an example, a rabbit of 2.6 kg. weight was given an injection of 6 c.c. of glucose solution (50 per cent. glucose in 0.85 per cent. saline). Eighteen minutes later 2.1 c.cm. of 0.12 per cent. HCN (*i.e.* 0.97 mg./kg.) were injected. Taylor's experiments showed that glucose had a certain value in marginal cases.

	Died	Recovered	Total
Following Forst's procedure with glucose	5	4	9
Controls without glucose	7	2	9
With twice the dose of glucose	3	6	9
Controls without glucose	8	1	9



The following experiment is an example of Violle's procedure:

40 c.c. of 10 per cent. glucose were injected intravenously, and 60 c.c. into the peritoneal cavity. One hour afterwards the animal was exposed to air containing HCN 1.79 gm. per cubic m. Twelve pairs of rabbits were subjected to the above procedure (with, in some cases, slight variations) the glucose gave no immunity to the HCN, when the latter was inhaled.

As a prophylactic against HCN vapour glucose, therefore, has no practical value, and therefore from the practical point of view the subject may be dismissed. On the theoretical side two or three interesting points arise.

(1) Why should glucose reduce the susceptibility of the animal to HCN when the latter is injected, but not when it is inhaled? The probable answer is that in the case of injection, once the dose is introduced, the body has no further access to HCN, but in the case of inhalation there is always a background of HCN which at each circuit of the blood through the lungs, replenishes what has been oxidised, or at least does so as a first approximation.

If the explanation is correct, glucose should benefit a case which after a short period of inhalation of HCN was taken out of the toxic atmosphere.

(2) Does the glucose act in reality chemically? There is a possible alternative to this idea that the glucose acts by transforming the cyanide into cyanohydrin. It is that the glucose increases (as indeed it does) the volume of the blood, and that the same injection put into a greater volume of blood produces a less concentration of cyanide in the blood, and consequently a blood stream less toxic to the tissues. This simple explanation seems not to be the correct one, for according to Taylor's researches, cane sugar, which produces similar osmotic effects in the body, does not increase the tolerance of the body to HCN. Moreover, dilution of the blood with "gelatine saline" does not increase the tolerance. On the other hand, acetone, which acts chemically like glucose, produces a similar degree of resistance to HCN on the part of the animal.

*Rabbits.* 0.4 c.c. per kg. of 26 per cent. acetone injected subsequently given 1.1 mg. HCN per kg. subcutaneously.

	Died	Recovered	Total
Acetone animals	2	6	8
Control animals	5	3	8

The benefit is, however, only in the marginal cases administration of 1.2 mg./kg. of HCN killed all the animals, whether given acetone or not.

### (c) Administration of Nitrites.

The most recent suggestion made by Mlodveanu and Gheorghin (1929) is the use of sodium nitrite as an antidote against HCN. The suggestion is that the nitrite reacts with urea in the body, produces CO<sub>2</sub> and so stimulates the respiratory centre. It is claimed that after a dog has ceased breathing as the result of HCN, respiration may be started again on the injection of sodium

nitrite. "If several minutes after the stoppage of respiration an intravenous injection of 10–20 c.c. of a freshly prepared 1 per cent. solution of nitrite be injected" respiration will be restored. These experiments have as yet been incompletely controlled.

## REFERENCES.

- EVANS, C. LOVATT (1919). *J. Physiol.* 53, 17.  
FORST (1928). *Arch. f. exp. Path. u. Pharm.* 128, 1.  
HENDERSON and HAGGARD (1927). *Noxious Gases*, p. 110. New York.  
HEYMANS and SOENEN (1927). *C.R. Soc. Biol.* 96, 202.  
HYND (1927). *Biochem. J.* 21, 1904.  
KATZ and LONGFELLOW (1923). *Serial Report No. 2405 of the American Bureau of Mines.*  
KELLIN, D. (1925). *Proc. Roy. Soc. B*, 98, 312.  
— (1929). *Ibid.* B, 104, 206.  
LUMSDEN (1923). *J. Physiol.* 57, 357.  
MLODVEANU and GHEORGHIN (1929). *C.R. Soc. Biol.* 102, 164.  
TAYLOR, H. (1930). *J. Physiol.* 69, 124.  
— (1931). *Ibid.* (in press).  
VEDDER (1925). *The Medical Aspects of Chemical Warfare*. Baltimore.  
VIOLE (1926). *Bull. Acad. méd.* 95, 664.  
WARBURG, O. (1923). *Biochem. Zeitschr.* 136, 266.  
— (1928). *Ueber die katalytische Wirkung der lebendigen Substanz*. Berlin.

(*MS. received for publication 31. VII. 1930.—Ed.*)