

+ Microscopy Fluorescence

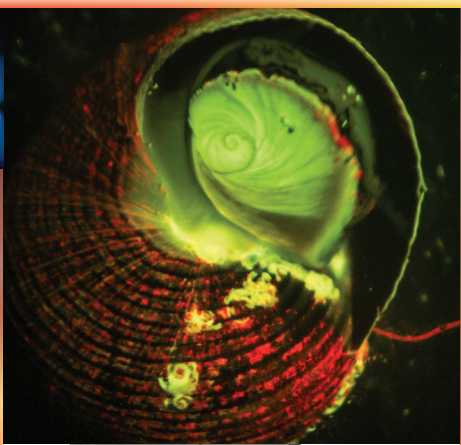

= NIGHTSEA Fluorescence Viewing Systems

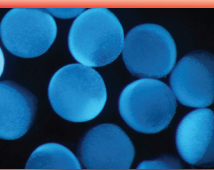
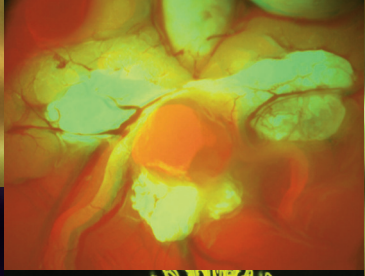
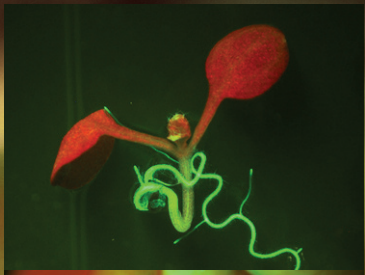
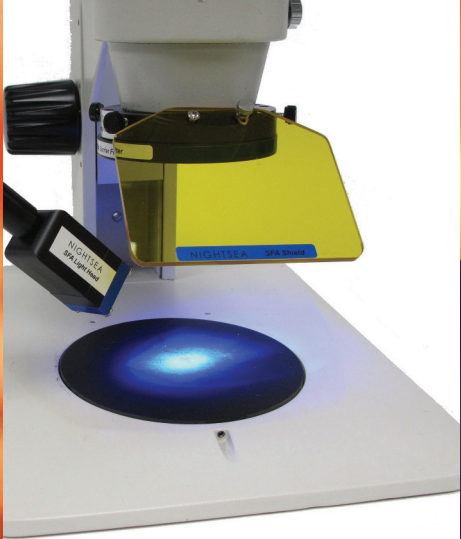

Fluorescence
isn't just for
research
microscopes
anymore...

NIGHTSEA™ Stereo Microscope Fluorescence Adapter

Adapt your existing lab stereo microscopes for fluorescence

The NIGHTSEA™ Stereo Microscope Fluorescence Adapter adapts just about any stereo microscope (dissecting microscope) for fluorescence with no modification to the microscope itself. The modular design lets you easily switch between several different excitation/emission combinations to work with a variety of fluorescent proteins and other fluorophores. There are now five different excitation/emission combinations available, plus white light.

Applications

- Quick screening of your fluorescent genotypes — *Drosophila*, zebrafish, *C. elegans*,...
- Genotype sorting
- Fluorescence-aided dissection, injection, or micromanipulation
- Freeing up your research-grade fluorescence microscopes for more demanding work
- New faculty start-up budgets
- Bringing fluorescence into teaching laboratories

CONTACT US FOR
MORE INFORMATION...

EMS has it!

**Electron
Microscopy
Sciences**

P.O. Box 550 • 1560 Industry Rd.
Hatfield, Pa 19440
Tel: (215) 412-8400
Fax: (215) 412-8450
email: sgkcck@aol.com
or stacie@ems-secure.com

www.emsdiasum.com

Precision, Speed, Stability

NANO-POSITIONING FOR MICROSCOPY & IMAGING



Manual Stage
25x25mm Travel



High-Speed Nanofocus
<1nm Resolution



XYZ Flexure Stage
<1nm Resolution

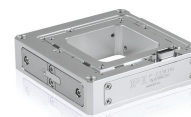

UHV Piezo Stage
0.1nm Resolution, XYZ

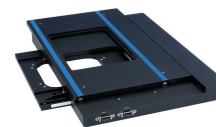

XY Piezo Motor
Stage, 100mm

The Broadest and Deepest Portfolio of Precision Motion Technologies



Vacuum Stages



Piezo Mechanics

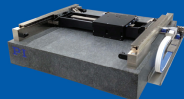

Air Bearings



Fiber Alignment



Hexapods

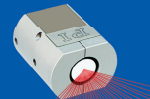

Beam Steering

Learn more ► www.pi-usa.us
508.832.3456
PI (Physik Instrumente)

SEM & TEM Sample Preparation

Microscopy



DESK V TSC Sample Coater

- Fully automated
- Minimize sample charge
- Reduce e-beam damage
- Increase secondary electron emissions

BENCH TOP TURBO Evaporation Tool for Tissue and Life Science

- Carbon coating
- Sputtering
- AC glow discharge
- Low-voltage thermal evaporation

Support Performance Value

DV-502

Large Sample, High Throughput
Sputter & Evaporation

- Rotary shadowing for metals and carbon
- High vacuum gate valve for rapid cycling
- Recipe development

RAISING THE STANDARD FOR MICROANALYSIS

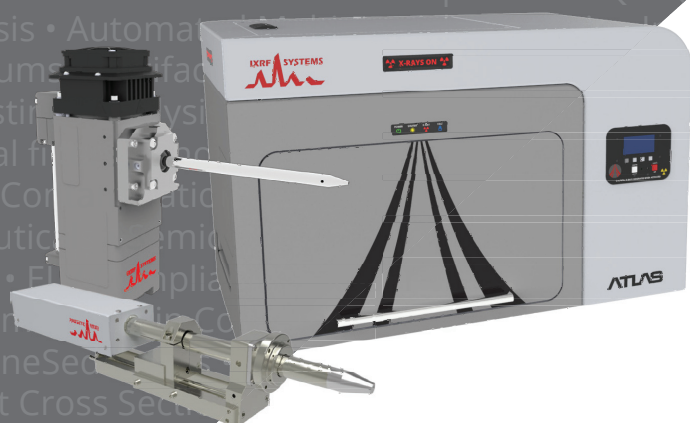

MICRO-XRF

Benchtop XRF

The ATLAS™ Micro-XRF spectrometer (μ XRF) from IXRF Systems introduces a new world of x-ray mapping and automation. The ATLAS™ boasts the largest chamber volumes under vacuum, SDD detection areas up to 150mm², well as the smallest spot size (5 μ) available on the market.

SEM-XRF

Electron beams produce very high backgrounds hiding trace elements in a sample. X-rays do not have this affect. Thus, coupling an X-ray Fluorescence (XRF) source to an SEM allows the user to identify and quantify low ppm levels of elements, improve quantitative accuracy, separate peak overlaps, and even produce trace level x-ray maps to reveal elemental distributions.



IRIDIUM ULTRA EDS

EDS Microanalysis for the SEM

Iridium Ultra EDS will change the way you analyze your data. Our software suite boasts analytical tools for the beginner, as well as the experienced user. Iridium Ultra includes advanced spectra, imaging, mapping, particle analysis and microscope stage/column control tools standard with every system, as well as, a lifetime software license for free software upgrades.

Have an old system you need to upgrade?

Have an older system and need something new? No problem! IXRF can replace everything or just the EDS analyzer and software. Keeping the existing detector can save substantially on cost. IXRF electronics interface with nearly every EDS detector or can rebuild, maintain and support your existing detector. IXRF guarantees resolution and light element performance.

VISIT US AT
M&M 2017 BOOTH #1211

Contact Us:

info@ixrfsystems.com | www.ixrfsystems.com | 512.386.6100

IXRF SYSTEMS



SOFTWARE MADE SIMPLE

Meet Sam.

He's eight years old and just ran his first in situ experiment with the Protochips Clarity™ software suite. With its simple user interface and intuitive workflow, Clarity™ lets you stay focused on what matters – your experiment.

Find out more about Sam's experiment at:

www.protochips.com/bibliography



 **Protochips**
Quantifiably Better™

SIA

1 TO 50 MEGAPIXELS live and slow scan
MAGNIFICATION FACTOR OF 1 on bottom mounted cameras
DIFFRACTION BEAM STOP on side mounted cameras

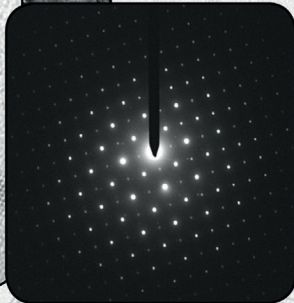
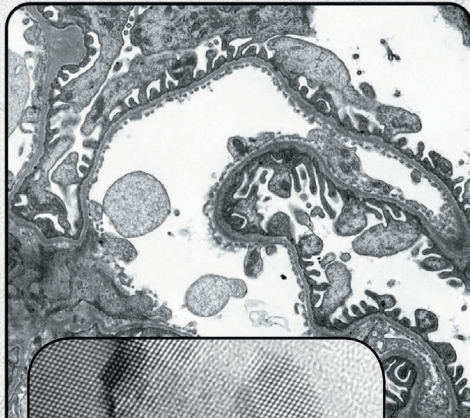

Affordable TEM camera systems for research, education, healthcare, and industry since 2001

Scientific Instruments and Applications
2773 Heath Lane • Duluth, GA 30096
(770) 232 7785 • www.sia-cam.com



VIBRATION ENGINEERING CONSULTANTS

Over 33 years of professional experience providing *independent* tests, certifications, and services, including:

- Site Surveys
- Magnetic Field Cancellation Systems, including installation
- Stiffness Testing
- Facilities Problem Solving for vibration, acoustics, and magnetic field resolution
- OEM Consulting

Let us help you make an *independent*, informed decision to maximize performance from your microscopy investment

Contact us today at 831-465-9189 or visit our website www.vibeng.com

We're Really BIG on TINY

We make **Tiny Holes** in molybdenum, platinum and other materials. Diameters from 10 μ m all the way down to 100nm.

We make **Tiny Tools** in diamond, glass and other materials, all supporting linear dimensions less than 10 μ m for imaging, metrologic probes, nanomechanical testing and other applications. Fully turned geometries of submicron radii are feasible.

We make **Tiny Marks** as micrographic inscriptions in a great variety of materials for branding security, tracking, optoelectronic testing and other purposes.

We certainly can't predict what you might want these tiny items for, but with over twenty years of experience making them, we invite you to get in touch with us. We may be able to put a demonstration piece or prototype into your hands within a matter of just weeks.

We're really big on tiny things.

Norsam Technologies, Inc. | www.norsam.com | Phone 505.984.1133

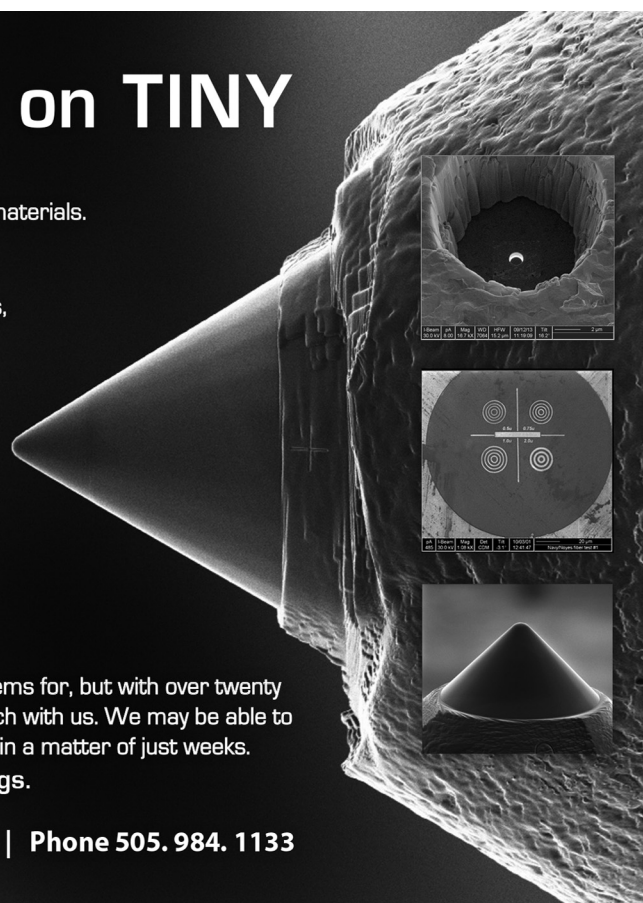

INDEX TO ADVERTISERS

Bruker Nano GmbH	A9, A21
Denton Vacuum	A11b, A16b
Diatome	Cover 2, A23
EDAX, Inc.	A14
Electron Microscopy Sciences, EMS	Cover 3, A15
FEI Company	A6, A22
Hitachi	Cover 4, A3
IXRF Systems, Inc.	A17
Norsam Technologies, Inc.	A20a
Physik Instrumente	A5b, A16a
Protochips	A13, A18
Scientific Instruments & Applications (SIA)	A11a, A19a
Tescan	A10, A24
Vibration Engineering Consultants	A19b
XEI	A5a
ZEISS	A12, A25

Someone has to be first.
XFlash® FlatQUAD, multiple detector systems & VZ

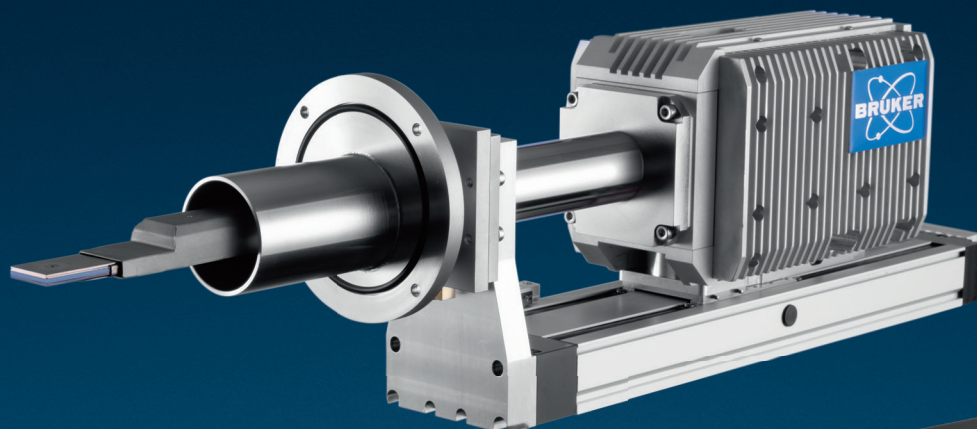

Analyze textured
samples with ease.



- The unique XFlash® FlatQUAD offers a large solid angle and an amazing take-off angle. This minimizes shadowing so you can see every nook and cranny of your sample in record time.
- Bruker's multiple detector systems provide large solid angles and great take-off angles too. You can start with one detector building up to four, depending on your needs.
- The Variable Z (VZ) adapter allows you to optimize take-off angles in-situ, which significantly improves the analysis of topographically challenging samples.

Someone has to be first.



www.bruker.com/quantax-flatquad

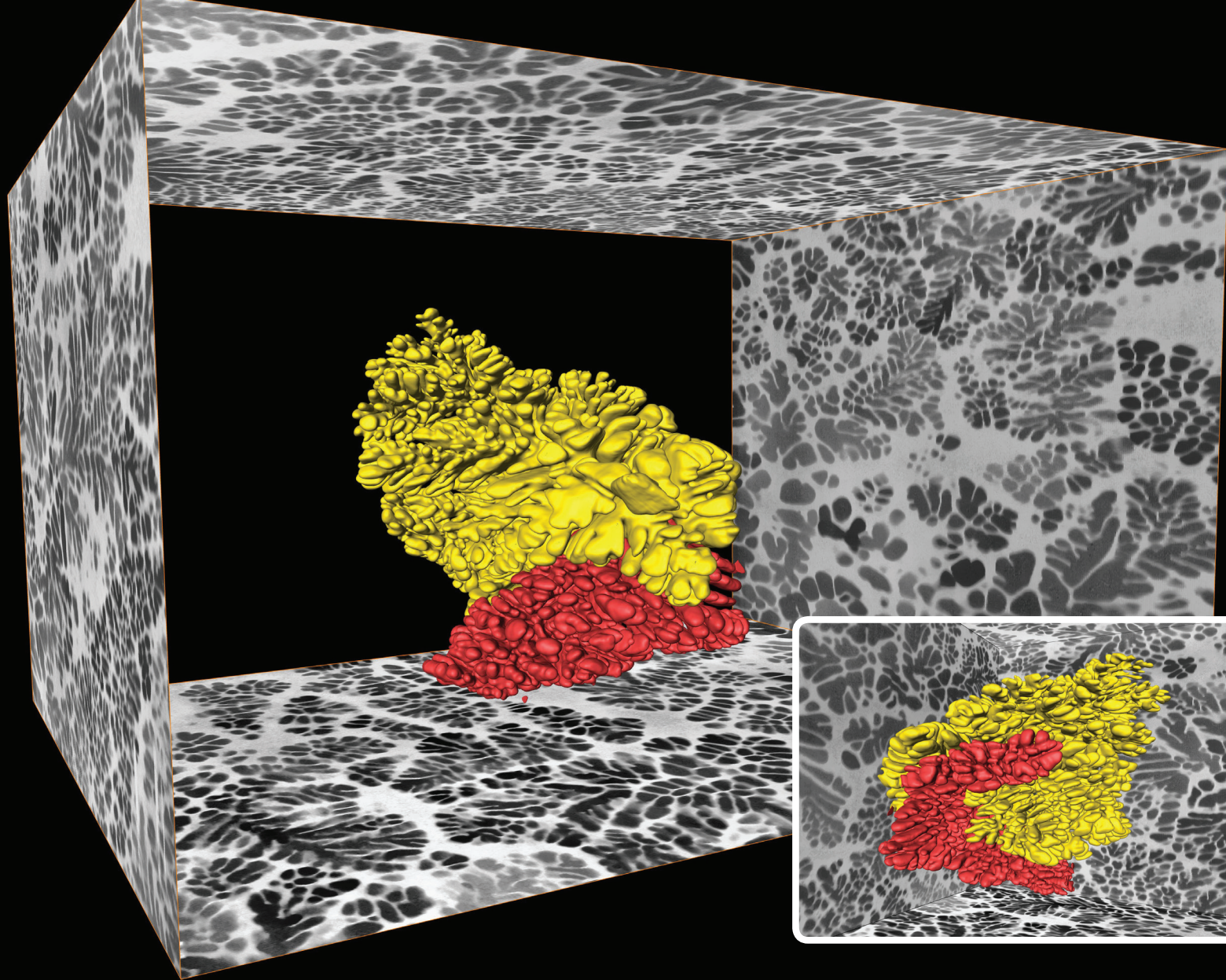

FEI Avizo® 3D visualization of two large adjacent crystalline dendrites of a bulk-metallic-glass matrix composite ($Zr_{58.5}Ti_{14.3}Nb_{5.2}Cu_{6.1}Ni_{4.9}Be_{11.0}$). Data was obtained by large volume serial sectioning tomography using the Helios PFIB DualBeam. The sectioned block is about $90 \times 80 \times 70 \mu m^3$. Sample from The University of Tennessee, USA. Images courtesy of The University of Manchester.

Large 3D volumes with unprecedented surface resolution

Until recently, available technologies have limited the volumes and depths of materials that can be analyzed at high resolution, ultimately restricting the insight into structural, crystallographic, and chemical properties. This is no longer the case. The Helios™ PFIB DualBeam™ offers unrivaled access to regions of interest deep below the surface—combining serial section tomography with statistically relevant data analysis.

Discover more at FEI.com/Helios-PFIB



Incomparable...

...and still innovating



DiATOME diamond knives

ultra 45° • cryo • histo
ultra 35° • histo jumbo
cryo immuno • ultra sonic
ultra AFM & cryo AFM
trimtool 20 • trimtool 45
trimtool 90

Over 40 years of development,
manufacturing, and customer service

DiATOME U.S.

P.O. Box 550 • 1560 Industry Rd. • Hatfield, Pa 19440
Tel: (215) 412-8390 • Fax: (215) 412-8450
email: sgkcck@aol.com • www.emsdiasum.com

Free customer service

Sectioning tests with biological and material research specimens of all kinds. We send you the sections along with the surfaced sample, a report on the results obtained and a recommendation of a suitable knife. Complete discretion when working with proprietary samples.

Re-sharpening and reworking service

A re-sharpened Diatome diamond knife demonstrates the same high quality as a new knife. Even knives purchased in previous years can continue to be re-sharpened. The knives can be reworked into another type of knife for no extra charge, e.g. ultra to cryo or 45° to 35°.

Exchange service

Whenever you exchange a knife we offer you a new DiATOME knife at an advantageous price.

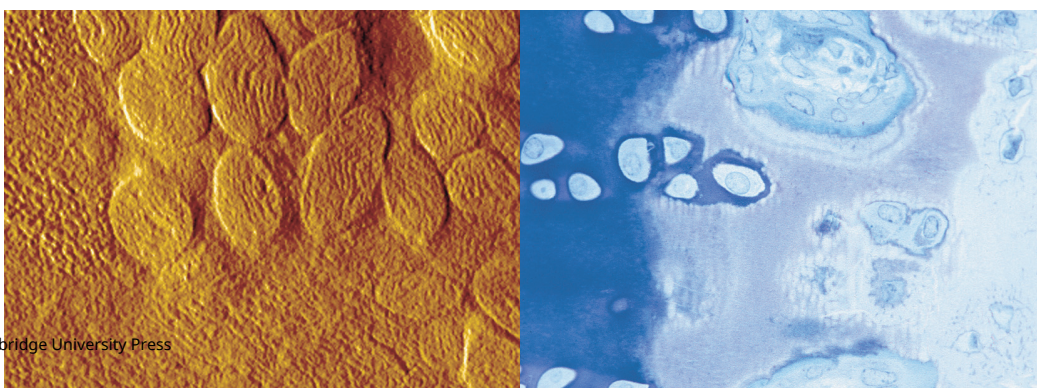

The Swiss Army Knife of Microscopy

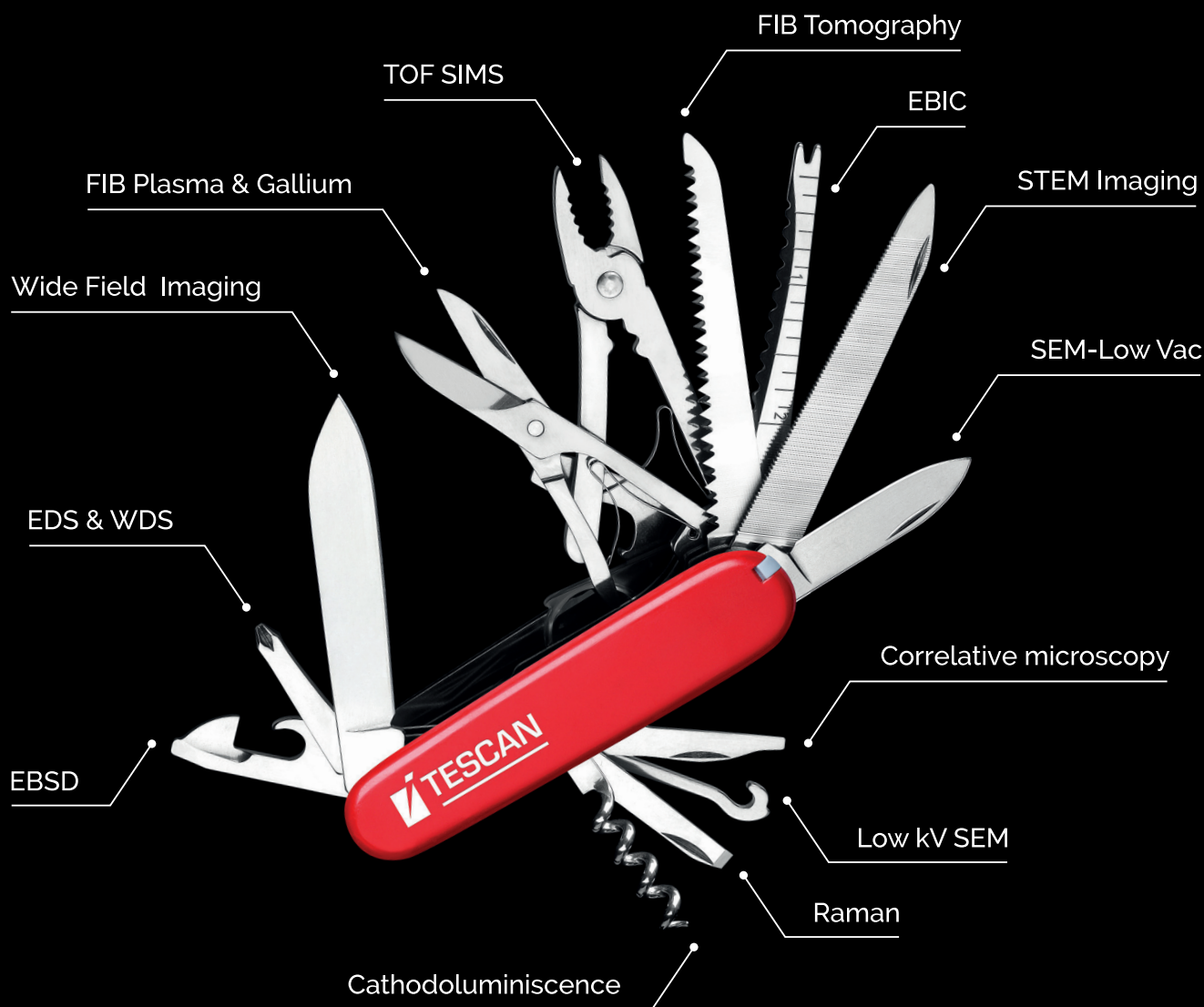

Always have the right
tool on hand!



Visit **TESCAN USA** at **M&M 2017**

www.tescan-usa.com | 724-772-7433

Imaging at sub-nanometer resolution.

ZEISS GeminiSEM

// INSPIRATION
MADE BY ZEISS

GeminiSEM 500

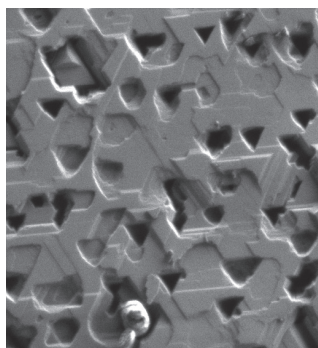

Sample courtesy of A. Charai, Aix
Marseille University, France.

Your field emission SEM for subnanometer, surface sensitive images

Image effortlessly with sub-nanometer resolution and high detection efficiency, even in variable pressure mode. You always acquire excellent images from any real world sample. **Visit the ZEISS booth #1018 at M&M and see GeminiSEM in action.**

www.zeiss.com/geminiSEM



If you are interested in attending or sponsoring an ImmunoGold/Silver Staining Workshop please give us a call and ask for Stacie Kirsch.

Reactions of Participants:

"We are very enthusiastic and will most certainly pursue this method!"

"The time for personal advice was excellent!"

"An abundance of practical info, built on the necessary theoretical background!"



Electron Microscopy Sciences is the exclusive distributor of Aurion products in the United States.

clear, clean, reproducible, and reliable results

AURION Immuno Gold/Silver Staining

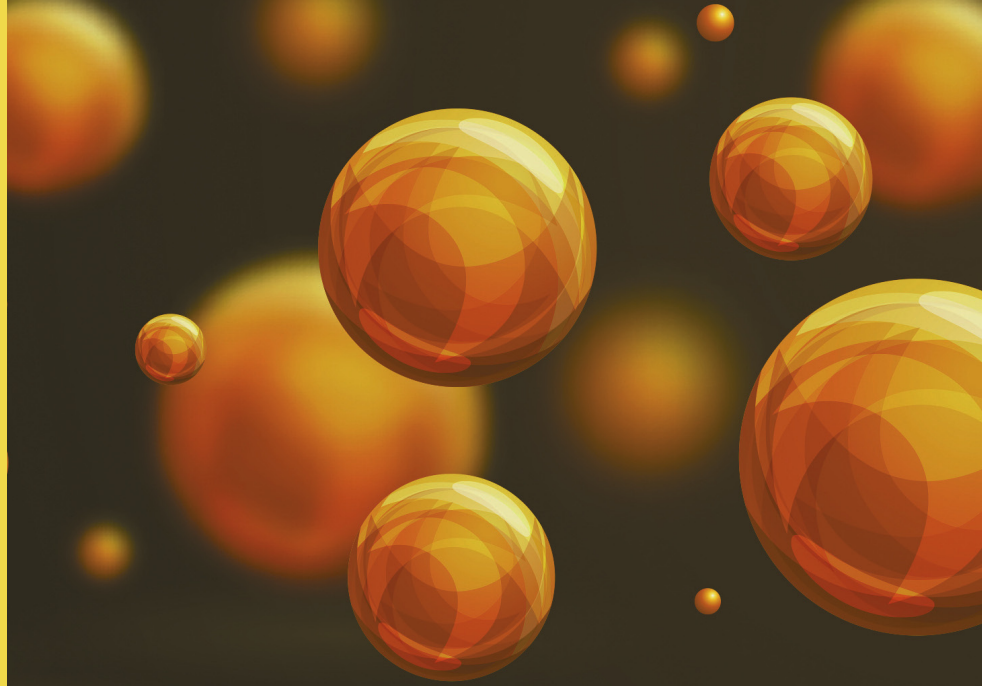

...EMS has it!

CONTACT US FOR MORE INFORMATION...

**Electron
Microscopy
Sciences**

P.O. Box 550 • 1560 Industry Rd.
Hatfield, Pa 19440
Tel: (215) 412-8400 • Fax: (215) 412-8450
email: sgkcck@aol.com
or stacie@ems-secure.com

OUR MAIN INTERACTIVE WEBSITE:
www.emsdiasum.com

 TO REQUEST A COPY
OF OUR CATALOG:
[www.emsdiasum.com/
requests/catalog](http://www.emsdiasum.com/requests/catalog)

 TO VIEW OUR
DIGITAL CATALOG:
catalog.emsdiasum.com

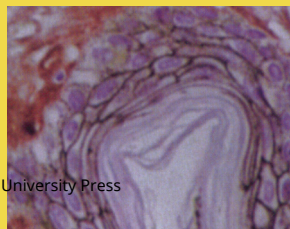
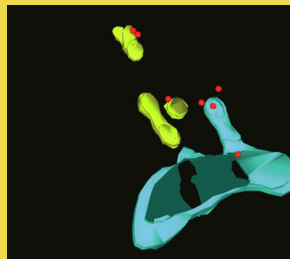
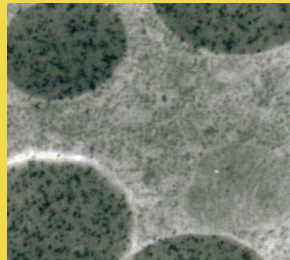

Here at Electron Microscopy Sciences we are very proud to be the exclusive agents of Aurion, the leading manufacturer and developer of a complete line of ImmunoGold Reagents and Accessories in the Netherlands. Aurion is led by the renowned Dr. Jan Leunissen, whom many of you may know through his books that he has written on ImmunoGold labeling as well as the workshops he teaches throughout the world.

Over the years the Aurion line has grown and has been further enhanced to include many unique and exclusive products not available elsewhere. Today their line includes not only the more commonly known reagents for EM and LM but, as well, a newly introduced line of products such as Silver Enhancement specifically for EM, Ultra-Small Fab fragments, Blocking Solutions, and even a line of donkey gold conjugates.

With all of the new additions to the line up Aurion and EMS have something for everyone in the ImmunoGold Field.



The NEXT Generation of 120 kV TEM

Innovation, Performance, and Reliability—The All New Hitachi *HT7800* Series

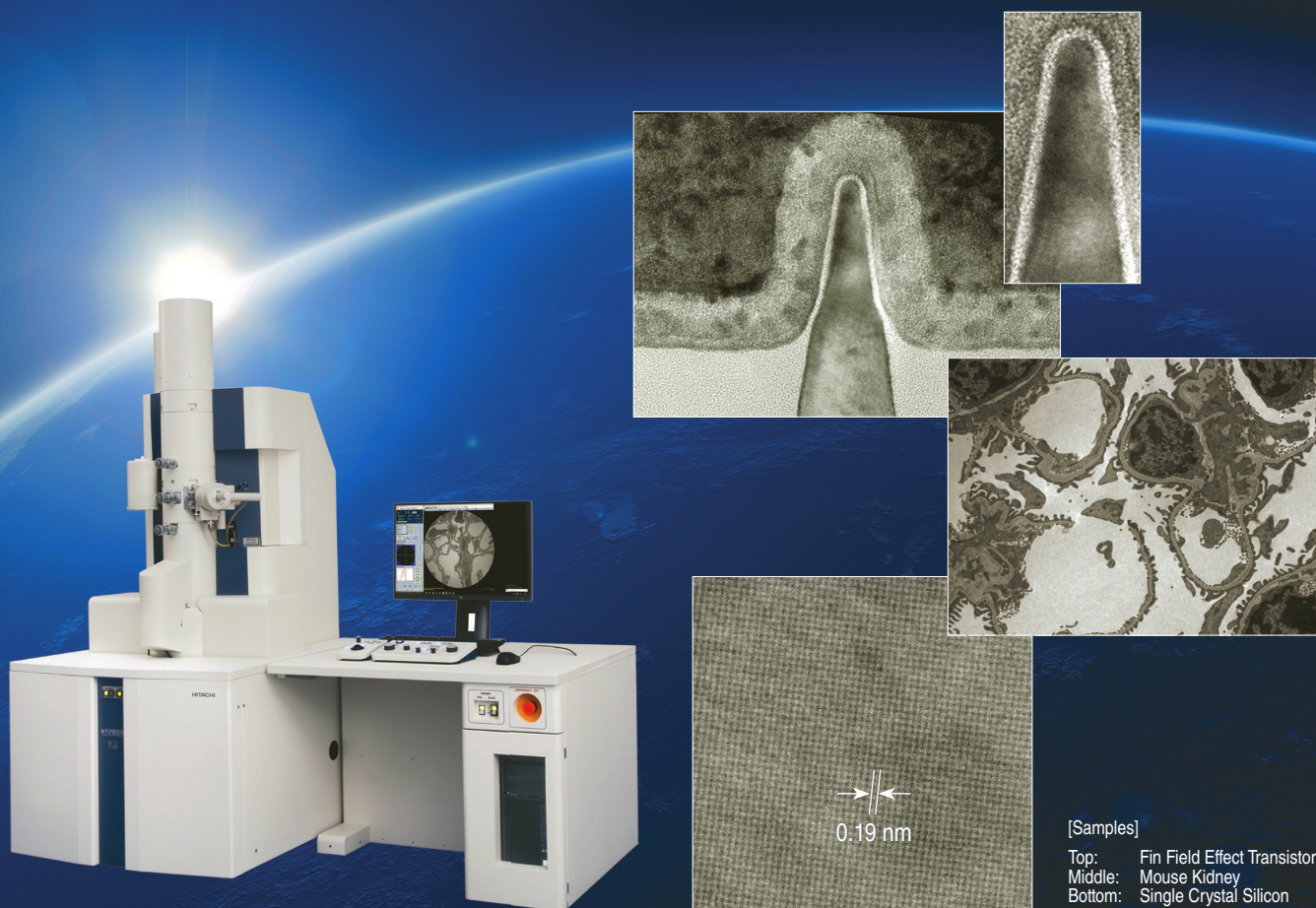

[Samples]

Top: Fin Field Effect Transistor
Middle: Mouse Kidney
Bottom: Single Crystal Silicon

Hitachi's advanced electron optics and dual-mode lens technology redefine the boundaries of 120 kV TEM performance. With ≤ 0.19 nm on-axis resolution, the highest contrast in its class, and diverse analytical capabilities for Material Science and Life Science fields, the *HT7800* Series provides a complete solution for all your TEM imaging needs.

For more details, contact us at: microscopy@hitachi-hta.com

Think Outside the Lab