

NEW APPLICATIONS OF RADIO HOLOGRAPHY FOR MM OBSERVATIONS WITH THE RATAN-600 RADIO TELESCOPE

VLADIMIR KHAIKIN

*The Special Astrophysical Observatory of Russian Academy of Sciences,
N.Arkhys, 357147, Karachai-Cherkessia, Russia
Tz:123244 ZENIT SU, FAX:(7-812)315-17-01, email:rukh@sao.stavropol.su*

ABSTRACT

In the paper we describe the results of active holography RATAN-600 surface testing including the measurements of a single element profile and topography. The RATAN-600 beam pattern at 3.2 mm after an antenna correction and its dynamics during daytime are presented.

INTRODUCTION

The RATAN-600 has been planned and built as an instrument enabling us to reach maximum resolution for a reflector radio telescope in the wide wave range from 30 to 1cm (Korolkov, Parijskij, 1979). The improvement of the radio telescope reflecting surface and the development of holography surface testing have provided us with the possibility to work in MM wave range of a very big reflector and in future - of a big array(Parijskij et al.,1992). New radio holography applications help us to achieve the above mentioned goals.

THE HOLOGRAPHY TECHNIQUE AND EQUIPMENT

Figure 1: A scheme of holography measurements at the RATAN-600

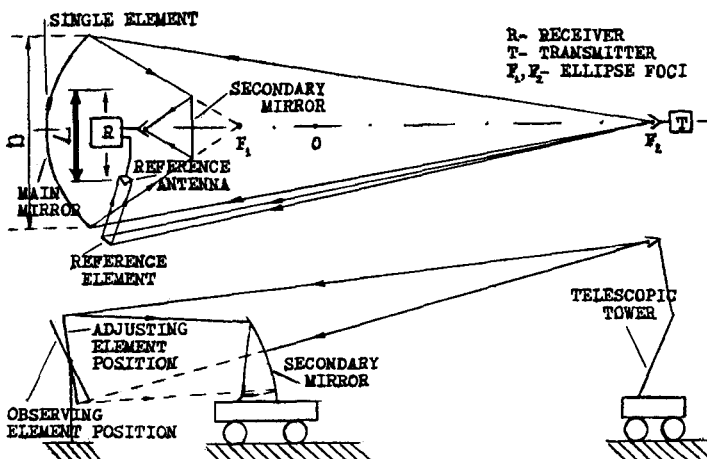

The main advantage of the method we use is radio holography measurements in the mode which is maximally close to the process of radio astronomical observations (Khaikin, 1991). Fig.1 gives a scheme of holography measurements at the RATAN-600 with the use of a remote ground based signal source.

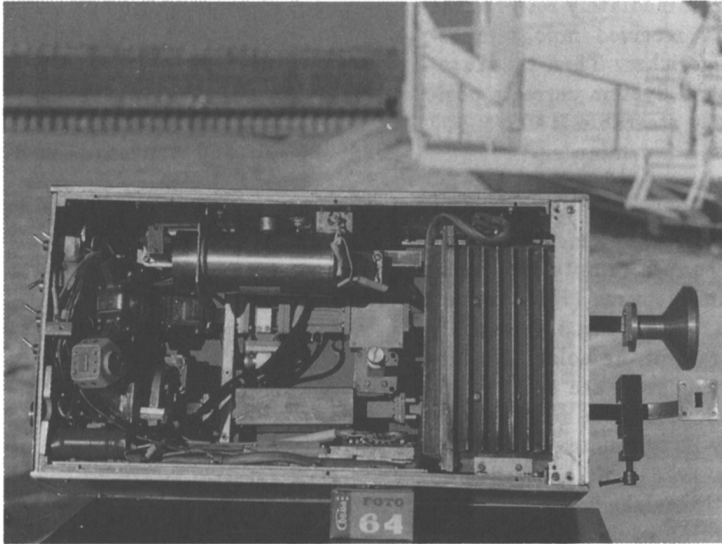

Figure 2: The two-channel holography receiver at 22 GHz

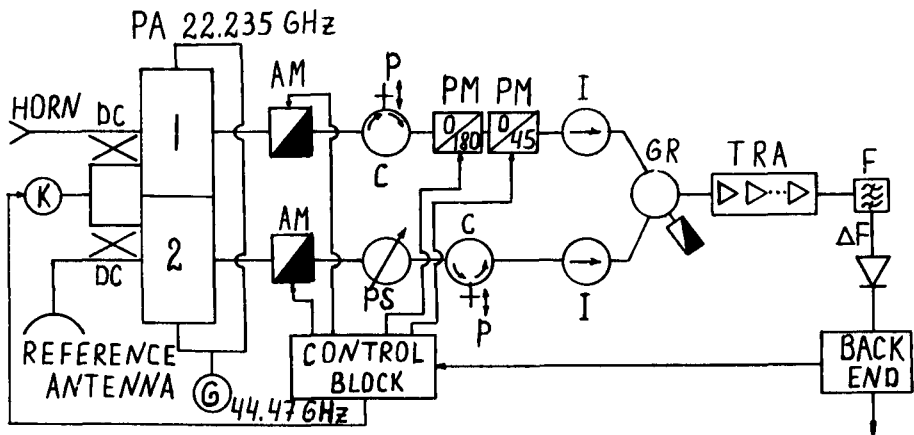

Figure 3: A block diagram of the holography receiver. PA - two-channel parametric amplifier with common pumping, PS - linear phase shifter, PM - phase modulator, GR - gibride ring, TRA - FET amplifier, AM - amplitude modulator, G - pumping, K - calibration

A radio hologram is recorded while the platform with the holography receiver is moving along the focal line of the Secondary mirror. IBM AT 386 placed in the Laboratory building immediately restores the "ON-LINE" received hologram using FFT algorithm. Then the Automatic Control System corrects positions of fully steerable RATAN-600 elements in a few minutes.

The two-channel holography receiver at 22.235 GHz specially designed for holography measurements with the use of a remote ground or strong cosmic source (H_2O maser) is given in Fig.2. Fig.3 presents a block diagram of the holography receiver. A linear phase shift is applied in the receiver to avoid output holography image distortions (Bennet et al., 1976). It is similar to the Leith-Upatnieks "off-axis" hologram recording in optics.

The characteristics of the receiver and phase devices used are given in (Khaikin, Yaremenko, 1991; Romanov et al., 1991). High phase stability of the receiver front end (Dvoyan et al., 1991) guarantees good quality of holography recording. In Fig.4 two one-dimensional holograms recorded in the daytime with 0.5 hour difference demonstrate a high repeatability of holography recording.

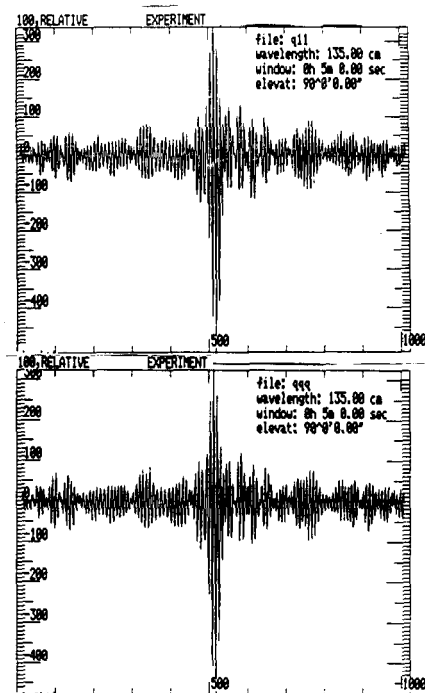

Figure 4: Two holograms recorded with 0.5 hour difference

HOLOGRAPHY TESTING OF THE RATAN-600 SURFACE

Fig.5. presents the results of holography measurements of the RATAN-600 surface with element numbers from 640 to 670 before and after the antenna correction. The substantial improvement of both the aperture phase(radial element positions) and amplitude (angle element positions) are demonstrated. As the result r.m.s. accuracy of mutual elements alignment is improved from $\sigma = 0.54mm$ to $\sigma = 0.083mm$. Residual surface distortions correspond to the RATAN-600 Automatic Control System precision. The accuracy of single measurement performed by this method during the daytime is equal to $50\mu m$.

The complete cycle holography measurements - antenna correction - holography measurements for radio telescope sector (225 element) can be performed in 15-20 min if the most important radial coordinate is corrected. To correct all the three coordinates several one-dimensional holograms with different angle antenna positions should be recorded and an antenna correction takes 30-35 min.

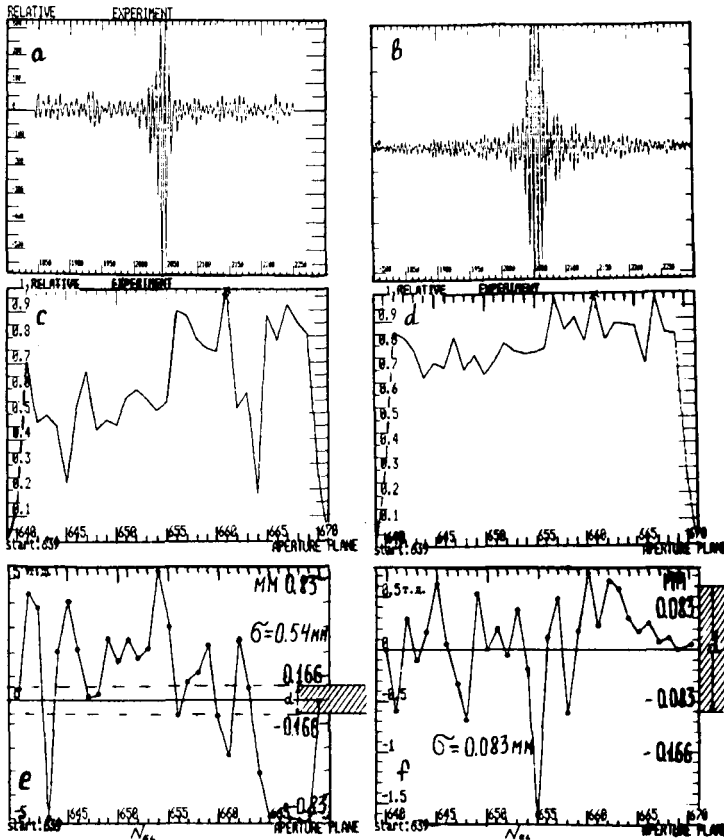

Figure 5: Holography testing and correction of the RATAN-600 surface. N_{EL} -element number, holograms (a,b), aperture amplitude distributions (c,d) and radial element positions (e,f) before (left) and after(right) the antenna correction

HOLOGRAPHY MEASUREMENTS OF A SINGLE RATAN-600 ELEMENT

In Fig.6. the holography measurements of surface integral profiles (by vertical coordinate) for elements numbered 640 and 670 are given. The concavity(el.670) or the salience(el.640) of the restored integral profiles are the result of the difference between the real curvature radius (R_r) of the given element and optimal one (R_o). The calculation of R_o , which depends on the element position, focus position etc. allows us to estimate R_r for given element. For 640 and 670 elements occasional deviations of the ideal profile form are $\sigma = 0.16 \text{ mm}$ and $\sigma = 0.11 \text{ mm}$. The integral profile measurement takes only 5 min with repeatability better than $10 \mu\text{m}$ and horizontal resolution of 10 cm .

Fig.7 demonstrates repeatability of the method. The integral profile of

669 element is restored here by 3 holograms recorded one by one (exp.12-14). The r.m.s. error of the difference between the profiles in experiments 12 and 13 (except trend) is less than $2\mu\text{m}$. The biggest profile difference about $8\mu\text{m}$ is between the 12-th and 13-th experiments (Fig. 8).

To do a surface map of an antenna element a two-dimensional hologram

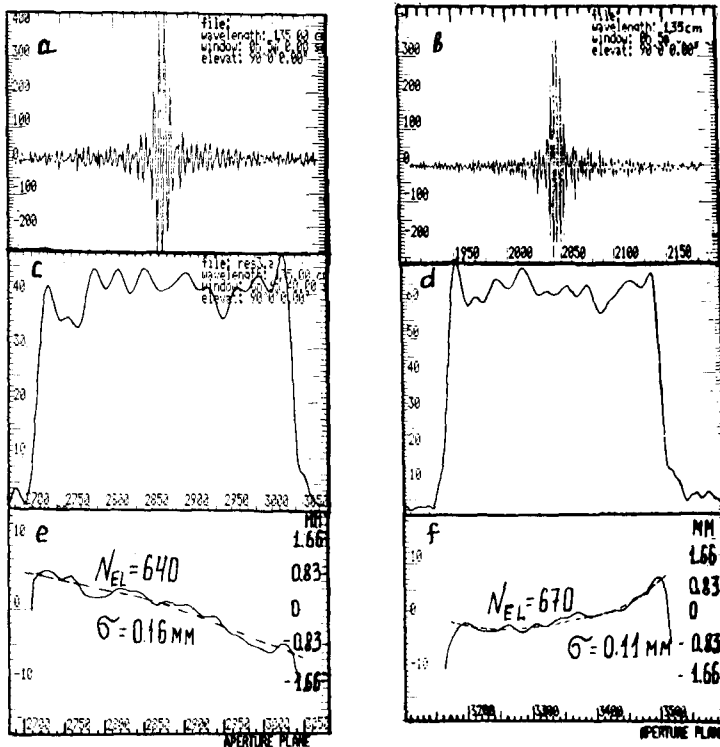

Figure 6: The holograms(a,b), aperture field amplitudes(c,d) and surface integral profiles(e,f) of 640 and 670 elements

should be recorded which at the required resolution of $20 \times 20 \text{ cm}$ (the distance between the adjustment screws at the panel surface) takes 1.5 hours. The accuracy of a holography recording in this case is limited by amplitude and phase fluctuations of close to ground atmosphere level at the RATAN-600. $100\mu\text{m}$ accuracy of the restored surface map can be reached during the night time when the level of phase atmosphere fluctuations is usually less than $\sigma = 3^\circ$.

To estimate the influence of other factors distorting a two-dimensional hologram and restored aperture field the far-field modeling of the reconstruction process was provided(Fig.9). The noise, limitations of recording region, non-linear phase shift etc. were taken account of. As the basic model we take a rectangular aperture whose small element has been phase shifted to $\lambda/4$ (Fig.9 a)

Fig.9 shows that the given field distribution in the aperture can be successfully restored using *FFT* even if the noise level is as high as -40 dB (S/N

Figure 7: The aperture amplitude distribution(left) and integral profile(right) of 669 element restored by 3 holograms

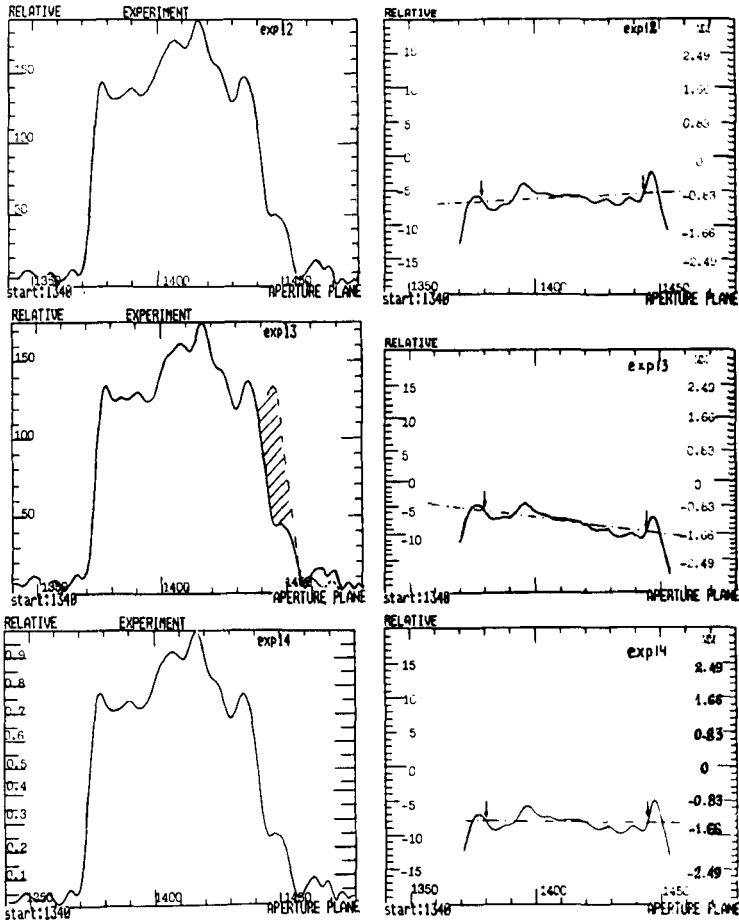

ratio in the hologram), but cutting of the hologram part, the noise and non-linearity of phase shift lead to extension of the output image size and the appearance of "higher" images(Fig.9 i-l).

Fig.10 presents 9 of 20 sections of the two-dimensional hologram recorded for one of the RATAN-600 element. During the hologram recording a fully steerable element scans by the azimuth coordinate with the angle shift after each scan.

Fig.11 shows the results of the experimental hologram processing.

Figure 8: The difference between profiles in 12 and 13 experiments

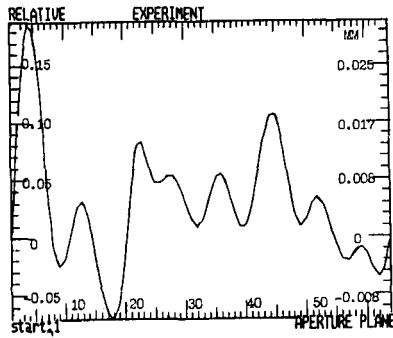

The primarily installed test plate of $85 \times 20\text{cm}$ size can be clearly distinguished at the restored aperture (Fig.11 g). Significant oscillations of the restored aperture amplitude in the real experiment (Fig.11 f) are induced by the near region position of the signal source (Fig 1). They can be excluded with the use of the Fresnel transform algorithm. We consider the real resolution achieved in the output image to be equal $\delta y \times \delta x = 40 \times 20\text{cm}$. The extension of the hologram recording region could enable us to reach the required resolution of $20 \times 20\text{cm}$.

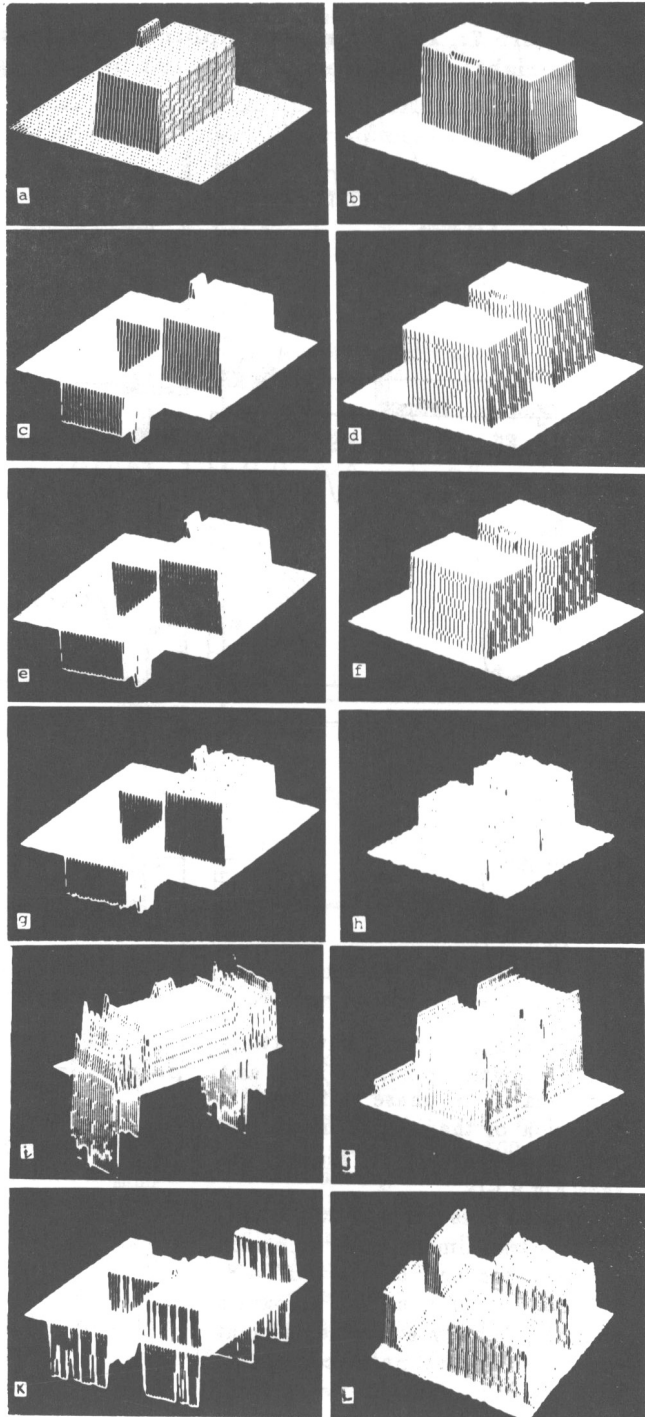

Figure 9:

Modeling

of the aperture field reconstruction.

The given phase (a) and amplitude (b), restored real and imaginary aperture phase (left) and amplitude (right); i, j, k, l - images in the case of cutting of the hologram part. Noise level: 0 dB (c, d, i, j), -40 dB (e, f), -80 dB (g, h, k, l)

Figure 10:
The scans with numbers 1, 4, 5, 6, 10, 11, 17, 19, 20 of 20 scans hologram recorded in the real experiment at the RATAN-600

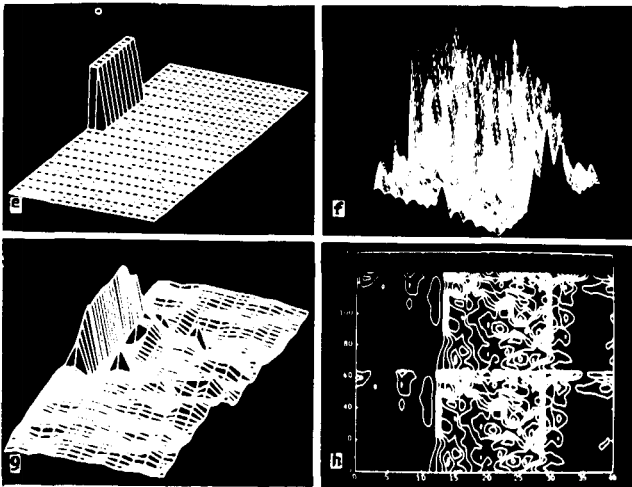
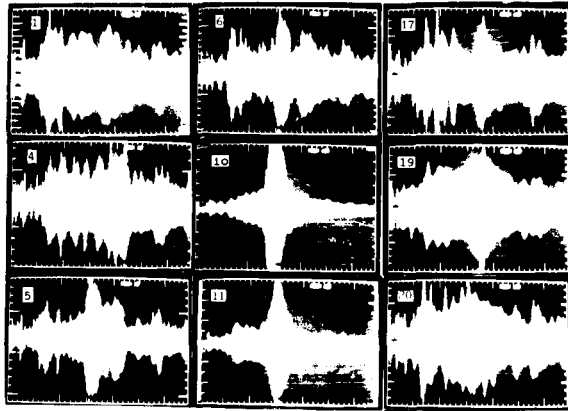

Figure 11:
The restored aperture field phase and amplitude of a single panel in the real experiment, g - phase, f - amplitude, e - primarily installed test plate at the element surface, h - aperture amplitude map.

THE RATAN-600 BEAM PATTERN AT 3.2 MM

Fig.12 demonstrates the RATAN-600 beam pattern obtained at 3.2 mm and its dynamics due to antenna temperature deformations in the most unfavorable time the next day after the antenna correction. The estimation of the two-dimensional RATAN-600 beam pattern at 3.2 mm shows that immediately after the antenna correction about 25% of energy is concentrated in the beam pattern main lobe and a holography antenna correction is desirable before the radio

astronomical observations at *MM* waves.

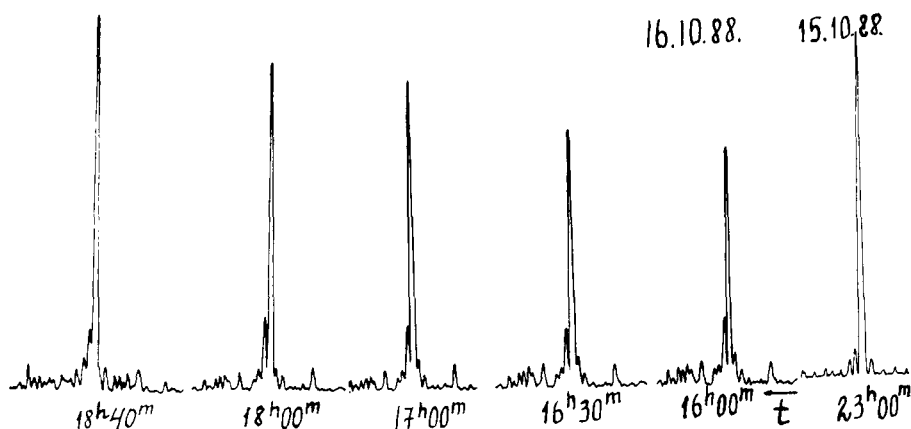

Figure 12: The RATAN-600 beam pattern at 3.2 mm and its dynamics in the daytime

CONCLUSION

Active holography techniques developed at the RATAN-600 can be successfully utilized at other radio telescopes. We offer cooperation to all those who need active and precise testing of a radio telescope surface.

REFERENCES

- Bennet, J.C., Anderson, A.P., McInnes, P.A. and Whitaker, A.J.T. 1976, AP-24, N.3, pp.295-303.
- Dvoyan, G., Piroumian, H. and Khaikin, V. 1991, Proceedings of International Workshop on Holography in N.Arkhyz, Russia, pp.88-89.
- Khaikin, V. 1991, Proceedings of XIV ESA Workshop on Antenna Measurements in Noordwijk, Netherlands.
- Khaikin, V., Yaremenko, A. 1991, Proceedings of International Workshop on Holography in N.Arkhyz, Russia, pp.82-84.
- Korolkov, D.V., Parijskij, Yu.N. 1979, Sky and Telescope, N.4, pp.324-329.
- Parijskij, Yu.N, Pinchuk, G.A., Verkhodanov, O.V., Khaikin, V.B., Zverev, Yu.K., Zhekanis, G.V. 1992, These Proceedings.
- Romanov, G, Trehovitskij, O., Khaikin, V. and Puzakov, A. 1991, Proceedings of International Workshop on Holography in N.Arkhyz, Russia, pp.85-87.