

The Journal of Laryngology and Otology

EDITED BY
WALTER HOWARTH

WITH THE ASSISTANCE OF
V. E. NEGUS AND F. W. WATKYN-THOMAS

Contents

VERTIGO	W. RUSSELL BRAIN
LABYRINTHINE TESTS AND THEIR AID TO DIAGNOSIS	ALEX. R. TWEEDIE
SECONDARY THIERSCH GRAFTING OF THE RADICAL MASTOID CAVITY THROUGH THE MEATUS	W. I. DAGGETT and G. H. BATEMAN
CLINICAL RECORDS—	
PUNCTURED WOUNDS OF THE ŒSOPHAGUS	A. J. WRIGHT
THROMBOSIS OF THE AXILLARY VEIN ASSOCIATED WITH CHRONIC EMPYEMA OF THE MAXILLARY SINUS	H. V. FORSTER
EPISTAXIS: ITS TREATMENT BY SUB-MUCOUS INJECTIONS	N. ASHERSON
SOCIETIES' PROCEEDINGS—	
ROYAL SOCIETY OF MEDICINE—SECTION OF OTO- LOGY AND SECTION OF LARYNGOLOGY	
VIENNA RHINO-LARYNGOLOGICAL SOCIETY	
AUSTRIAN OTOLOGICAL SOCIETY	
ABSTRACTS—	
THE EAR	THE NOSE AND ACCESSORY SINUSES
THE NASO-PHARYNX	MISCELLANEOUS
LETTERS TO THE EDITOR	REVIEW OF BOOK
	GENERAL NOTES

London

Headley Brothers

109 Kingsway, W.C.2

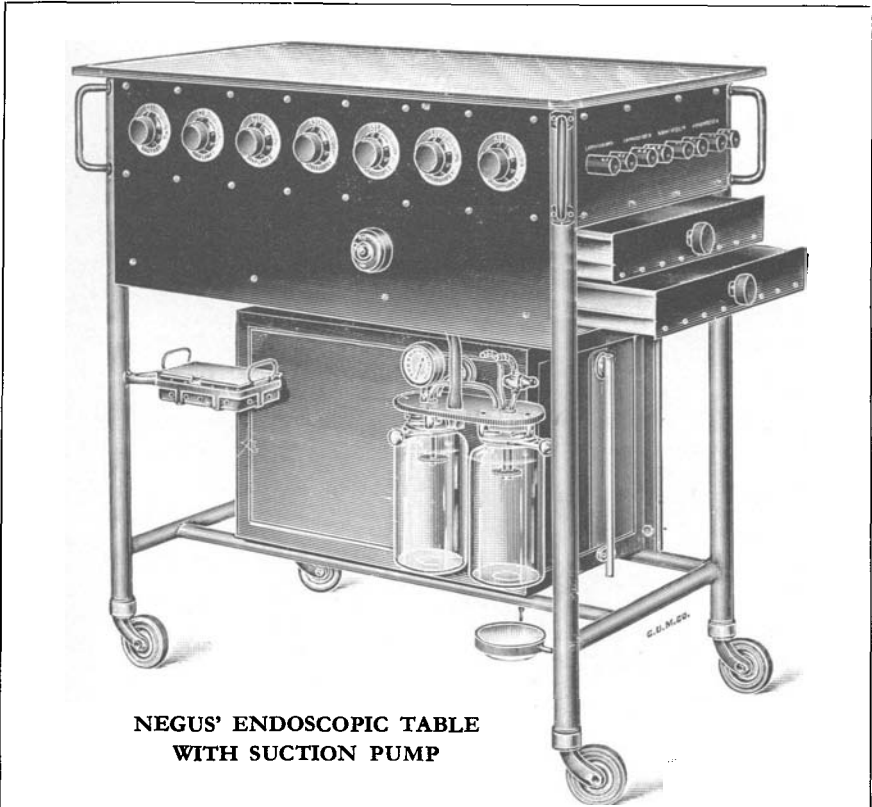

**NEGUS' ENDOSCOPIC TABLE
WITH SUCTION PUMP**

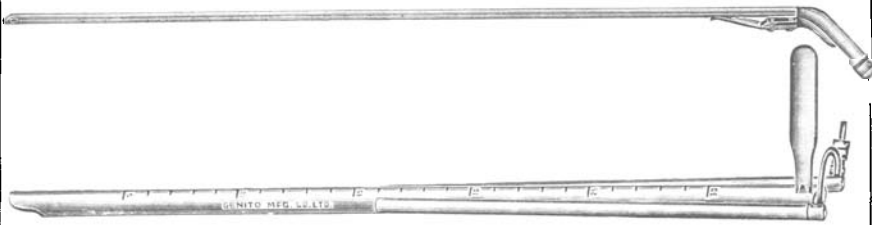

**Oesophagoscope with detachable Suction Tube and Proximal
Lighting as designed for V. E. NEGUS, M.S., F.R.C.S.
Obtainable in 4 sizes**

MADE BY

THE G_{ENITO}. U_{BINARY} MFG. Co. LTD.

28a DEVONSHIRE STREET, LONDON, W.1

Telephone:
WELBECK 3520, 3529

Telegrams:
CYSTOSCOPE, WESDO, LONDON

Please mention The Journal of Laryngology when replying to advertisements

**DOWN BROS.'
New Bronchoscopic Lamps**

A Shows the usual Howarth or Jackson Lamp which throws a forward shadow from the "pip" at the point.

B Shows the new HOWARTH pipless lamp giving even illumination.
(Foreign bulb. English mounting.)

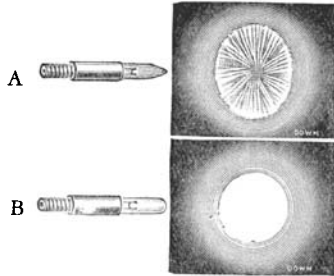

**NEW
PRISM
PANEL
AND
TWIN
ILLUMINATION
GIVING
CLEAN
SURFACE
AND AN
EVEN,
BRIGHT,
SHADOWLESS FIELD
OF
ILLUMINATION**

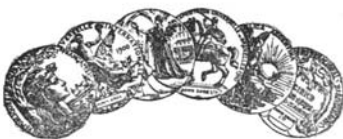
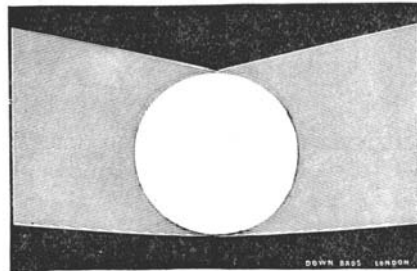
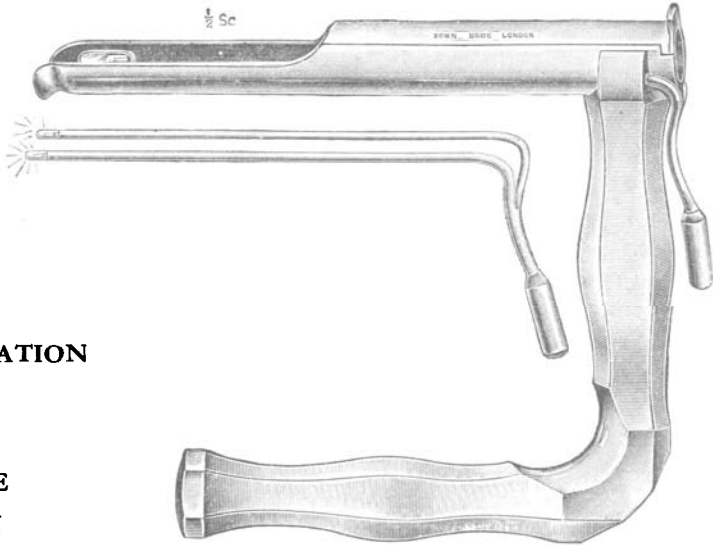

Telegrams—DOWN, LONDON
Telephone—HOP 4400 (4 lines)

Manufactured only by
DOWN BROS. LTD.
Surgical Instrument Makers
21 and 23 ST. THOMAS'S STREET
LONDON, S.E. 1
(Opposite Guy's Hospital)

Please mention *The Journal of Laryngology* when replying to advertisements

DeVilbiss

AEROL ATOMIZER COMBINATION No. 100

Price of Complete Outfit	6/-
2 oz. refills	2/6
1 oz. refills	1/9

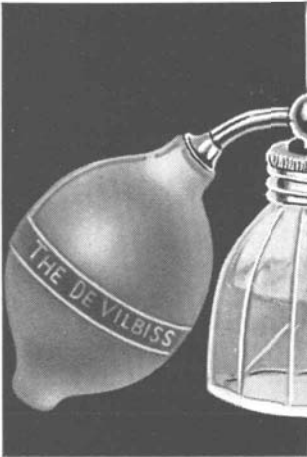

This highly efficient DeVILBIS Outfit meets the demand for a dependable nose and throat Atomizer already filled with an approved solution. It forms a convenient prescription in cases of common colds, influenza, catarrh, sore throats and hay-fever.

The Aerol Compound in this Atomizer contains Camphor-Menthol, Oil Pine Needles, Oil Cinnamon, Oil Thuja Occidentalis, Chlorbutol and Neutral Hydrocarbon Oil.

Obtainable from all chemists or from the Sole Distributors in the United Kingdom.

AEROGRAPH COMPANY LIMITED

43 Holborn Viaduct, London, E.C.1

CVB-58

CENTRAL LONDON

THROAT, NOSE AND EAR HOSPITAL

GRAY'S INN ROAD

(Near King's Cross Stations)

DAILY CLINICS. LECTURES ON FRIDAYS, 4 p.m.
 OVER 11,000 NEW PATIENTS YEARLY. 50,000 ATTENDANCES.
 IN-PATIENT DEPARTMENT (Hospital and Recovery Home), 104 BEDS. In-Patient Operations Daily.

SPECIAL INTENSIVE COURSE OF LECTURES AND DEMONSTRATIONS
 (including Operative Surgery Course; Anatomy and Physiology Class, Peroral Endoscopy Class and Pathology Class, especially suitable for D.L.O. Students), twice yearly—May and October.
 COURSES IN METHODS OF EXAMINATION AND DIAGNOSIS at frequent intervals.

SURGEONS

- | | |
|-------------------------|--------------------|
| Mr. HAROLD KISCH | Mr. C. GILL-CAREY |
| Mr. ARCHER RYLAND | Mr. J. D. MCLAGGAN |
| Mr. F. W. WATKYN-THOMAS | Mr. W. A. MILL |

ASSISTANT SURGEONS

- Mr. A. LOWNDES YATES, Mr. N. ASHERSON, Mr. W. G. SCOTT-BROWN

CLINICAL ASSISTANTS

Are appointed from among those duly qualified gentlemen who have been enrolled as Post-Graduate Students of the Hospital.

FEES

For attendance on the practice of the Hospital—
 Three months 5 guineas | Six months 8 guineas

Special Intensive Course—

Clinical Course, £5 5s., Operative Surgery, £7 7s., Endoscopy, £6 6s., Pathology, £5 5s.

Further particulars on application to

J. D. MCLAGGAN, M.A., F.R.C.S., Dean. JOHN H. YOUNG, Secretary-Superintendent

Please mention *The Journal of Laryngology* when replying to advertisements

Second Edition. Fully revised and enlarged. Large 8vo, 282 pages. With 123 Illustrations. 15s. net, postage 6d.

CHRONIC NASAL SINUSITIS

JUST
PUBLISHED

AND ITS RELATION TO GENERAL MEDICINE
By **PATRICK WATSON-WILLIAMS, M.D.** (Lond.).

FULLY
REVISED

Consulting Surgeon, Ear, Nose and Throat Dept., Bristol Royal Infirmary.

"Every practitioner would be well advised to possess it and to digest the lessons it teaches. . . . One of the milestones of medical progress."—*Practitioner*.

THIRD EDITION. FULLY REVISED AND ENLARGED.
Demy 8vo, 490 pp. 250 Text Illustrations and 19 plates (of which 8 are in colour). 20s. net, postage 9d.

DISEASES OF THE NOSE, THROAT AND EAR

For Practitioners and Students

Edited by **A. LOGAN TURNER, M.D., LL.D., F.R.C.S.E.**
Consulting Surgeon, Ear and Throat Department, Royal Infirmary, Edinburgh.

With the collaboration of

J. S. FRASER, M.B., F.R.C.S., W. T. GARDINER, M.C., M.B., F.R.C.S., J. D. LITHGOW, M.B., F.R.C.S., G. EWART MARTIN, M.B., F.R.C.S., and DOUGLAS GUTHRIE, M.D., F.R.C.S.

"May confidently be recommended for the use of students and practitioners."—*LANCET*.
"Will prove of the greatest value."—*JOURNAL OF LARYNGOLOGY AND OTOTOLOGY*.

Bristol: John Wright & Sons Ltd. Illustrated Catalogue free. London: Simpkin Marshall Ltd.

With 199 Illustrations (5 coloured). Demy 8vo. 25s. net. Postage 9d.

THE PRINCIPLES AND PRACTICE OF OTOTOLOGY

By

F. W. WATKYN-THOMAS, F.R.C.S., and A. LOWNDES YATES, M.C., M.D.,
B.Ch.Camb., Surgeon, Central London F.R.C.S., Hon. Assistant Surgeon, Central
Throat, Nose and Ear Hospital, etc. London Throat, Nose and Ear Hospital, etc.

"... a new book and a modern book . . . a tribute to the knowledge and energy of the authors . . . no otologist can afford to leave this work unread."—*JOURNAL OF LARYNGOLOGY AND OTOTOLOGY*.

"... contains a most valuable account of recent research in otology and provides a rich and abundant feast for the thoughtful."—*BRITISH MEDICAL JOURNAL*.

London: H. K. LEWIS & CO. LTD., 136 Gower Street, W.C.1

ROGERS' STANDARD SPRAYS

HAVE A
WORLD-WIDE REPUTATION
For Efficiency & Reliability

They are made in many forms, scientifically
designed for

NASAL, PHARYNGEAL, POST-NASAL
and LARYNGEAL TREATMENT

Particulars gladly supplied
on request

Sole Manufacturer—

FRANK A. ROGERS (LATE OF OXFORD ST.)

1 Beaumont Street, London, W.1

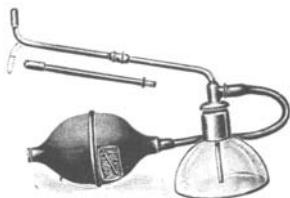

For Advertisement space in this Journal apply to:
HEADLEY BROTHERS, 109 Kingsway, London, W.C.2

Please mention *The Journal of Laryngology* when replying to advertisements

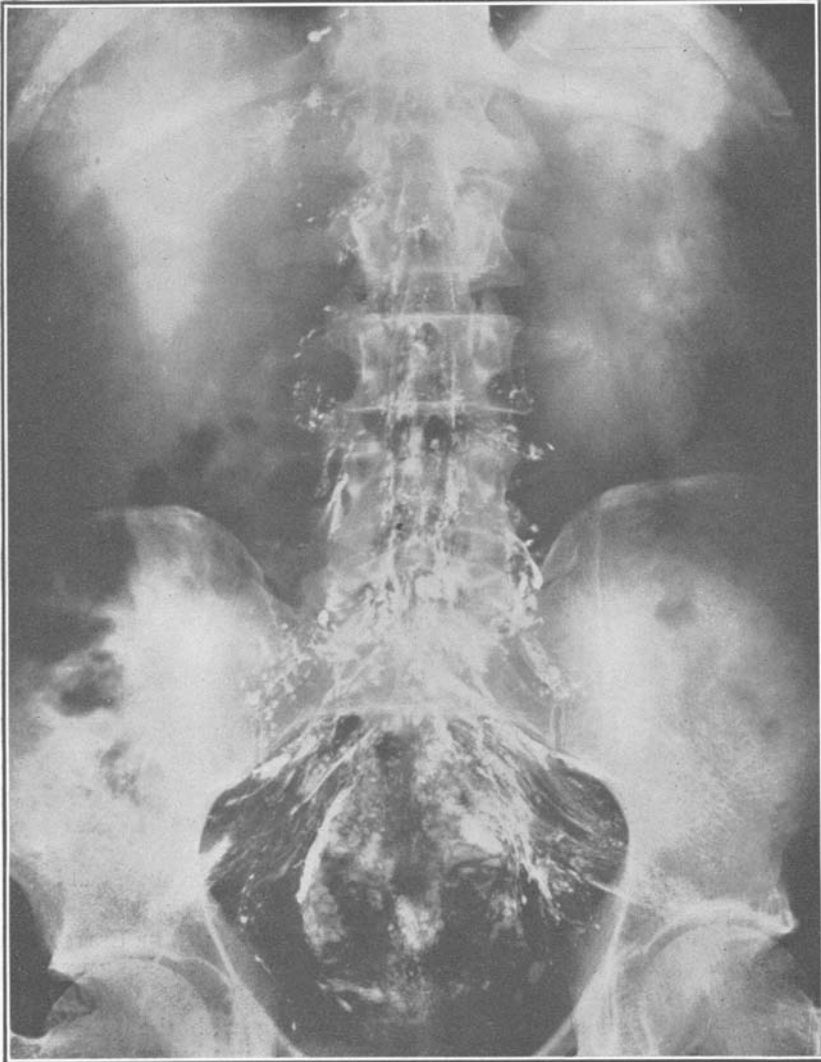

Epidural injection with Lipiodol.



ILFORD X-RAY
FILM
Super Speed Non-Abrasive
Uniform Quality

ILFORD LIMITED, ILFORD, LONDON

Please mention *The Journal of Laryngology* when replying to advertisements

The Journal of Laryngology and Otology

(Founded in 1887 by MORELL MACKENZIE and NORRIS WOLFENDEN)

EDITED BY

WALTER HOWARTH

ASSISTED BY

V. E. NEGUS AND F. W. WATKYN-THOMAS

1. Original Articles are accepted on the condition that they have not been published elsewhere.
2. Manuscripts should be typewritten, on one side only of the paper, and well spaced.
3. Galley proofs and engraver's proofs of illustrations are sent to the author. Corrections, which should be kept to a minimum, must be clearly marked and no additional matter added.
4. Orders for reprints should be sent when returning galley proofs, and for this purpose special forms are supplied, on which the price of the reprints is stated.
5. Authors of Original Communications on Oto-Laryngology in other Journals are invited to send a copy, or two reprints, to the *Journal of Laryngology*. If they are willing, at the same time, to submit their own abstract (in English, French, Italian, or German) it will be welcomed.
6. Editorial Communications may be addressed to THE EDITOR, *Journal of Laryngology*, c/o HEADLEY BROTHERS, 109 Kingsway, London, W.C.2.
7. The Annual Subscription commencing with the January issue is Forty Shillings, post free, and is payable in advance.
8. Single copies, both of the present and the previous series, are on sale at Four Shillings each.
9. All Subscriptions, advertising and business communications should be sent to the Publishers, HEADLEY BROTHERS, 109 Kingsway, London, W.C.2.

United States of America

Orders for this Journal, for single parts or yearly subscriptions, may be sent either through a local bookseller, or to Messrs. G. E. STECHERT & Co., 31-33 East 10th Street, New York.

Please mention *The Journal of Laryngology* when replying to advertisements

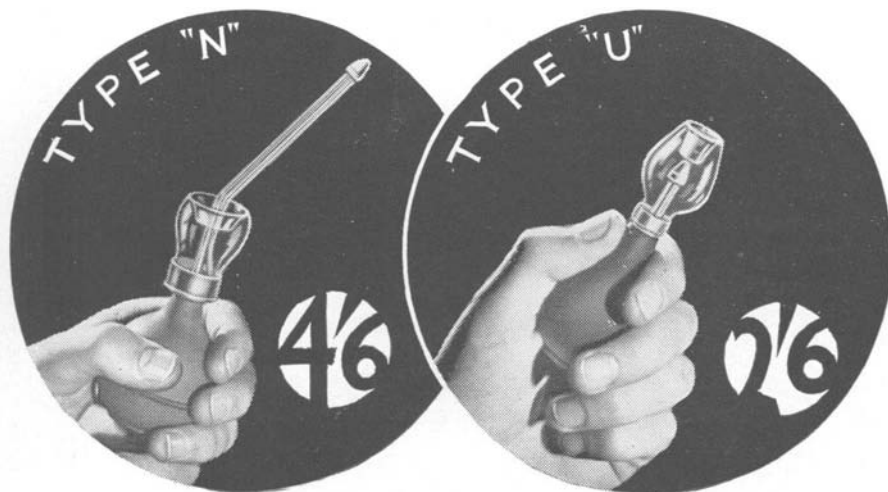

The
“MILLETT” ATOMISER
 BRITISH MADE

In introducing our product we suggested that—“the advantages of the Millett Atomiser are so evident, so obviously necessary that one wonders why they have not been adopted before.”

Sales have proved that we were correct. The Millett Atomiser does fulfil a demand.

Millett Atomisers require only one hand for use, the contents will not spill in any position.

The fluid is carried in a liberal glass bulb, and any type of liquid is perfectly atomised. All metal parts are chromium plated, and only the best rubber and glass is used. You cannot obtain a better atomiser at any price.

Model “N” for throat and nose use. Easily sterilised by removing the glass vessel from the base.

Model “U” for general and nasal use.

It is only necessary to put the exact dose into the atomiser.

- OBTAINABLE FROM ALL HIGH-CLASS CHEMISTS INCLUDING
 BOOTS THE CHEMISTS

Atomisers
 LIMITED

Proprietors of the “Millett” Atomiser Patents Makers of fine Sprayers and Atomisers

13 GREAT PULTENEY STREET, LONDON, W.1

Telephone Gerrard 1054

Please mention *The Journal of Laryngology* when replying to advertisements

CONTENTS

	PAGE
VERTIGO. W. Russell Brain	153
LABYRINTHINE TESTS AND THEIR AID TO DIAGNOSIS. Alex. R. Tweedie	160
SECONDARY THIERSCH GRAFTING OF THE RADICAL MASTOID CAVITY THROUGH THE MEATUS. W. I. Daggett and G. H. Bateman	169
 CLINICAL RECORDS—	
Punctured Wounds of the Œsophagus. A. J. Wright	175
Thrombosis of the Axillary Vein Associated with Chronic Empyema of the Maxillary Sinus. H. V. Forster	178
Epistaxis: its Treatment by Sub-mucous Injections. N. Asherson	180
 SOCIETIES' PROCEEDINGS—	
Royal Society of Medicine—Section of Otology and Section of Laryngology	182
Vienna Rhino-Laryngological Society	191
Austrian Otological Society	199
 ABSTRACTS—	
The Ear	203
The Naso-Pharynx	210
The Nose and Accessory Sinuses	211
Miscellaneous	214
 LETTERS TO THE EDITOR	 216
 REVIEW OF BOOK	 218
 GENERAL NOTES	 220