

1

Introduction to Quantum Physics and Measurement

1.1 Prologue

Quantum measurement sometimes has a bad reputation. No less an authority than J. S. Bell once wrote an article entitled “Against ‘measurement’” (Bell, 1990). Philosophers of physics are not usually fond of it either, usually only referring to it indirectly as the “measurement problem.” Practitioners of the physics of quantum measurement are sometimes derisively labeled as “instrumentalists.” Why then should we devote a whole book to the subject? The simplest answer is that the word *measurement* is essentially a shorthand for how we interact with the world. It is, strictly speaking, the only way we can gain information about the world, and only from the data we collect can we begin to formulate theories about the world around us.

In the context of quantum mechanics, as students and researchers of the field, we spend so much time dwelling on the mathematics of the subject – quantum states, observables, Hilbert spaces, symmetries, equations of motion, and so on – we sometimes forget that the results of experiments and every lived experience we have of the world involves none of those things directly. It only involves measurement. Without measurement, none of those mathematical objects would have any scientific meaning. It is this tendency to sweep measurement under the rug, as well as our role as an observer, that has, in our view, held back the further elucidation of quantum physics. Thus, while some physicists think of wavefunction collapse as the “ugly scar” on an otherwise beautiful theory (Gottfried, 1989), it is only by taking its scientific role seriously that we can make further progress in the understanding of quantum physics.

While both philosophy and mathematics will arise in this book, it is our goal to have a “physics first” approach to this subject. In the founders’ era of quantum mechanics, direct experimental evidence of many of the predictions of quantum mechanics was lacking because the necessary technology did not exist. This

resulted in most of the “experiments” from that time being *Gedankenexperiments*, that is, thought experiments about what might happen. In the subsequent decades, the situation has changed radically. Scientists and engineers have developed many new instruments and physical systems to be able to explore and test new phenomena and extreme limits of the theory to unprecedented levels. There are many new deep and exciting theoretical predictions and concurrent experiments in this subject that have come up in the past decades. In the chapters that follow, we will guide you through some of them. By putting experimental phenomena first, followed by a mathematical description, we will gradually gain an intuitive understanding of how quantum measurement works as an operational science.

Philosophical matters are nevertheless important. The past half-century or more has led to a sprouting up of numerous “interpretations” of quantum mechanics. A clear understanding about the various mathematical objects and physical predictions in the theory can lead to new understanding. These interpretations are a metanarrative, riding over the theory and attempting to give further meaning to the theoretical content as well as draw out possible philosophical implications. These interpretations are too often an *ex post facto* forcing of physical phenomena into contorted mental constructs. This brings us to our maxim regarding interpretations of quantum mechanics: the best interpretation is a fruitful interpretation. It is only by leading one to new insights and discoveries that an interpretation becomes more than a stumbling block. In the epilogue that concludes this book, we will give an outlook on the metaphysical understanding of the field and how interpretation can guide us in physical discoveries.

1.2 The Era of the Founders: 1920s–1950s

Quantum theory developed in the 1910s with the introduction of the Bohr model of the atom, and quickly entered its modern form in the 1920s with the complementarity principle of Bohr, the uncertainty principle of Heisenberg, and the wave equation of Schrödinger. Measurement entered quantum mechanics via a postulate which stated that interrogating a system results in a final state that is a single stationary state, or eigenstate, of the measurement apparatus. A system may at any time prior to this be in a superposition of such eigenstates, and measurement collapses the wavefunction into a well-defined outcome whose probability does not evolve in time. One notes that it is therefore not possible to directly access the full wavefunction of a system in a single measurement, and measurement necessarily causes disturbance. What then does the wavefunction actually represent?

While we are more comfortable now with the idea that all accessible information can be packed into a complex wavefunction that can be extracted in certain allowed

combinations using mathematical operators, the interpretation put forth by Max Born in around 1926 in a series of papers that linked the modulus squared of the wavefunction with the probability density to find the system it described was a tremendous step forward in linking abstract quantum quantities with measurement outcomes (Born, 1926). Born noted that the coefficient associated with a given eigenfunction, when the wavefunction is expanded in the basis of the measurement apparatus, represents the probability amplitude that such an outcome would be observed. Born received the 1954 Nobel Prize in Physics “for his fundamental research in quantum mechanics, especially for his statistical interpretation of the wavefunction.”

The measurement postulate, as originally conceived, is perfectly compatible with all past and future experimental results tested thus far. Nonetheless it is ad hoc and leaves much to the imagination with respect to the details of the measurement process itself. While a system evolves according to the Schrödinger equation, measurement was put forth as an “instantaneous” collapse of the wavefunction – a process that inherently assumes that information extraction is too fast to access, and is at odds with the fact that any physical apparatus has a characteristic measurement time. Moreover, there are many experimental situations that are not naturally suited to this canonical description. For example, the spontaneous emission decay of an atom ultimately results in the occupation of the ground state whether the atom was always in the ground state from the start or arrived there after a photon emission. More subtly, the measurement rate from the point of view of an external observer is not on equal footing for these two outcomes. For a relaxation event, a rapid quantum jump is the signature of the process, whereas if no such jumps are detected, we must wait much longer than the average decay lifetime to safely conclude the atom was originally in the ground state.

As such, since the early foundations of quantum mechanics, there was extensive discussion of the role of measurement, which was quite important in the thinking behind the Heisenberg uncertainty principle (Heisenberg, 1985). One of the most influential and systematic early thinkers in this area was Hungarian-American John von Neumann. In his classic text *Mathematical Foundations of Quantum Mechanics* (Von Neumann, 1955), originally published in 1932, von Neumann advanced an important line of research taking seriously measurement as a physical process. He recognized that an instantaneous measurement of, for example, energy would run afoul of the time-energy uncertainty principle, and that therefore it is not possible to carry out an arbitrarily precise measurement in a very short amount of time. This led him to develop a dynamical model of the measurement process, whereby the information about the system of interest can be extracted by coupling it to an auxiliary degree of freedom, or meter.

The meter, or probe, variable could be treated within a fully quantum mechanical framework, and then itself be detected using a recording device via the projection postulate. This procedure will be referred to as von Neumann's measurement model. It is an important advance because the combined system/meter/recording device is given a dynamical description, with its own Hamiltonian and equations of motion. This model can be seen as the precursor to later mathematical models of quantum dynamics, including decoherence theory, weak measurement, and quantum trajectories that will be addressed in later chapters of this text.

Nevertheless, the concept of instantaneous wavefunction collapse sparked much debate, including the celebrated paradox put forward by Einstein, Podolsky, and Rosen (EPR). A pair of entangled objects cannot, by definition, be described by concatenating independent descriptions of each constituent piece. Correspondingly, measurement outcomes of each element of the pair must be correlated, seemingly implying that if entanglement exists between physically separated objects, then quantum mechanics is capable of instantaneous, nonlocal influences. This led to the EPR paradox (Einstein et al., 1935), which raised the apparent incompatibility of this notion with locality since the information needed to generate the correlations associated with quantum mechanics would need to be exchanged faster than the speed of light if the two parts of an entangled pair are spacelike separated. This led EPR to conclude that the quantum description of reality as given by a wavefunction is not complete. Without further thought experiments that could prove the existence of quantum entanglement while simultaneously establishing the inability of any classical theory to predict these unique measurement outcomes, and without the experimental tools to access the EPR regime, this dilemma of, as Einstein put it, "Spooky Action at a Distance" lay dormant and unexplored until the arrival of John S. Bell (Fig. 1.1).

1.3 The Era of Bell: 1960–1970s

Alternative Formalisms to Cope with Reality

During the Second World War, science was mostly on hold. Notable exceptions are, of course, the Manhattan Project and development of the atomic bomb, harnessing nuclear physics for the war effort. Following that period, research in quantum mechanics was focused mostly on relativistic generalizations and on the growing field of particle physics. The 1960s was the golden age of field theory, giving rise to the systematic categorization of the many different particles that were being discovered, leading to the so-called standard model of particle physics. The existence of quarks proposed by Murray Gell-Mann and George Zweig in 1964 was verified with the discovery of all the quark species, the last being the top quark discovered

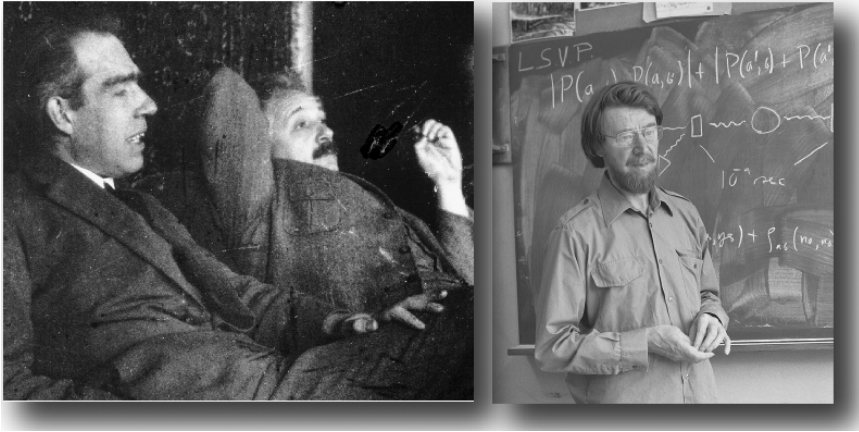

Figure 1.1 From left to right: Niels Bohr and Einstein debating the nature of reality. John Bell at the board, decorated with his famous experiment. Reprinted with permission from the Niels Bohr Library & Archives, American Institute of Physics, and CERN.

in 1995 at Fermilab. The final missing particle, the Higgs boson, proposed independently in three papers in 1964 by Brout, Englert, Higgs, Guralnik, Hagen, and Kibble, was finally discovered at the CERN particle collider in 2013.

While there were important contributions to quantum mechanics in this period (we mention, for example, Feynman’s path integral formulation in 1948 (Feynman, 1948) and the Aharonov–Bohm effect in 1959 (Aharonov and Bohm, 1959)), there was not much activity on what we may call the “fundamentals” of quantum mechanics. However, some scientists were unhappy with the philosophical implications of the dominant quantum interpretation, the “Copenhagen interpretation,” most systematically described by the Danish physicist Niels Bohr. They were following in the footsteps of Albert Einstein, who, although a co-founder of the field, was deeply disturbed by the intrinsic randomness of the theory, and the lack of a clear “realist” view of what quantum theory describes. In classical physics, we encounter the notion of randomness only as a lack of complete knowledge – for example, whether a flipped coin lands “heads” or “tails” is simply our practical inability to quickly integrate Newton’s equations from the given initial condition. The mathematical description of classical probability theory is given in Appendix A. However, in quantum theory, to the best of our knowledge, probability theory is inescapable. Identically prepared initial conditions can give rise to different final outcomes. Thus the concept of preexisting properties before measurement is generally rejected in quantum theory. This concept of a system’s property, like position, momentum, energy, and so on, existing without any reference to measurement or observers is what we mean by “classical realism.”

One of the more influential scientists of this era was David Bohm (1917–1992), who advanced another view of quantum mechanics. Bohm, together with Aharonov, reformulated the EPR argument (originally made for continuous position and momentum variables) in terms of measurements of components of spin-1/2 particles. They pointed out that currently it was practicable to test it experimentally only in the study of the polarization properties of correlated photons (Bohm, 2012; Bohm and Aharonov, 1957). Bohm had interpreted quantum physics in 1952 as describing an underlying real particle degree of freedom that was “guided” by an unobservable wave, sometimes called a “pilot” wave (Bohm, 1952a; Bohm, 1952b), called by Bohm a “hidden variable,” drawing from the earlier “hidden parameter” of John von Neumann (1955). This view of quantum mechanics is mathematically the same as that of Madelung’s hydrodynamic formulation of quantum mechanics (Madelung, 1926; Madelung, 1927) and philosophically similar to the early views of de Broglie (1927). It avoided the “no-go” hidden parameter theorem of von Neumann by also giving the detector an active role to play in the particle dynamics. The Bohmian interpretation had the feature of giving a clear mental picture of the particle degree of freedom, but suffered a number of drawbacks. When applied to more than one particle, such as in the Einstein, Podolsky, Rosen thought experiment (Einstein et al., 1935) (questioning the completeness of quantum mechanics), the pilot wave must act instantaneously across space and time in order to “guide” the particle to the correct detector result. That feature, together with an infinite number of variant theories possible, and difficulties in making a relativistically invariant version (which was already well established within standard quantum mechanics), led most physicists to discount it. However, the fact that such a reinterpretation of quantum theory was possible in the first place was an advance in foundations of quantum mechanics and motivation for further thought.

Bell Correlations, Testing Differences with Hidden Variable Theories

The issue lying in the background is whether quantum mechanics, like statistical mechanics, is an emergent theory describing a yet more fundamental physics of unobserved degrees of freedom, the abovementioned hidden variables. Further, if these hidden variables, exist, the thinking goes, perhaps they will restore our view of objective reality – where physics describes properties that exist before we measure them. The existence of the Bohm reinterpretation led John S. Bell (1928–1990) to think more broadly about the problem and to see what properties *any* theory that involved this type of hidden variable would have. In a groundbreaking paper published in 1964 in an obscure journal *Physics*, which only published four volumes between 1964 and 1968 (Bell, 1964), Bell published his inequality. The result of the inequality puts up a scientific conflict between a class of “hidden variable” theories

and quantum mechanics. The scientific nature of this inequality is quite important – it is not an interpretation of quantum theory, but an experimental test that these hidden variable theories must satisfy. The basic setup is that two particles, called S_1 and S_2 , are spatially separated such that no communication between them is possible that is faster than the speed of light, and then each is measured to collect data on its properties by two different measuring devices. Bell put in the ingredients that a naive scientific realist would want in a theory for this simple case:

- That the properties of each particle, called A and B , to be measured have definite, preexisting values, determined by the hidden variable.
- That statistical outcomes of measurements are simply the result of averaging over the hidden variables (which are produced randomly at the creation of the two-particle system with some unspecified distribution), as is the case in statistical mechanics.
- The “vital” assumption is that the result B for particle 2 does not depend on the detector setting for particle 1, nor result A for particle 1 on the detector setting of particle 2. Bell quotes Einstein: “But on one supposition we should, in my opinion, absolutely hold fast: the real factual situation of the system S_2 is independent of what is done with the system S_1 , which is spatially separated from the former” (Schilpp, 1949). The spatial separation should be sufficient that no causal influence can be transmitted faster than the speed of light, in accordance to the principles of relativity theory.

Some modern commentators also argue there is an implicit assumption of freedom of choice; the experimenters operating the measuring devices of particles 1 and 2 are free to change their settings at will (there is no superdeterminism). There are also more exotic hidden assumptions like no retrocausality.

In his six-page paper, Bell goes on to show that this class of “local realistic” hidden variable theories (local because of the third assumption, realistic because of the first) make definite predictions about the statistical result of measurements made with different settings of the two measurement devices: a correlation function of the measured data has certain bounds on its value, no matter what the distribution of hidden variables. Consequently, any experiment that violates the Bell bound on local realistic hidden variable theories will rule such theories out. Furthermore, quantum physics can violate that bound. It should be noted that not all hidden variable theories fit into this category. For example, the hidden variable theory of Bohm contradicts assumption 3, allowing nonlocal influences.

After Bell’s paper was published, the next obvious question was to test it: which was right, the above hidden variable theories, or quantum mechanics? An important step was the introduction of a modified inequality in 1969 by John Clauser, Michael Horne, Abner Shimony, and R. A. Holt, which was the test usually implemented

in the experiments (Clauser et al., 1969). There was a series of optical experiments testing the preceding inequality, focusing on the polarization degree of freedom of two entangled photons. In particular, we mention the 1972 experiment of Freedman and Clauser (1972), which shows Bell's inequality was indeed violated. Interestingly, the 1973 experiment by Holt and Pipken using atomic mercury to produce two-photon events at Harvard University (Holt, 1973) showed that Bell's inequality was *satisfied*, casting doubt on quantum mechanics! Clauser repeated the experiment (Clauser, 1976) and found, together with the independent experiment of Fry and Thompson (1976), that Bell's inequality was indeed violated in this type of system.

This created a series of Bell-type experiments that continue to the present day. Of great interest is the possibility of ruling out "loopholes" in the experiments, whereby some experimental imperfections or design flaw may not truly rule out local realistic hidden variables. We mention in particular the influential 1981 and 1982 experiments of Alain Aspect (Fig. 1.3) and coworkers Grangier, Roger, and Dalibard (Aspect et al., 1981; Aspect et al., 1982), the latter of which was the first to implement fast random switching of the polarization analyzers, faster than the light travel time between the measured systems. This ruled out the possibility of the setting of one polarizer being able to causally influence the outcome of the other (nonlocal) photon. Physicists also started violating Bell's inequality over longer and longer distances, such as the work of Nicholas Gisin's group showing violation using Swiss Telecom lines between two villages in the Geneva vicinity, separated by 18 km (Salart et al., 2008), testing the speed of the "spooky action at a distance." Recent notable experiments along these lines are a series of the experiments in 2015 designed to rule out two loopholes (also closing the "fair-sampling" loophole) in the same experiment (Hensen et al., 2015; Giustina et al., 2015; Shalm et al., 2015). An event-ready Bell experiment was subsequently made (Rosenfeld, 2017). These experiments are the most aggressive tests of local hidden variable theories to date and all showed that Bell's inequality remained violated. Consequently, we are stuck with quantum mechanics unless we want to break one or more of the assumptions of Bell's theorem. For these experiments the 2022 Nobel Prize in Physics was awarded jointly to Alain Aspect, John F. Clauser, and Anton Zeilinger "for experiments with entangled photons, establishing the violation of Bell inequalities and pioneering quantum information science."

Decoherence Became Fashionable with Zurek and Kraus

It is clear that dissatisfaction with ideas of quantum measurement is behind much of the work of Bohm, Bell, and others. This idea crystallized into what is sometimes called the "measurement problem." The basic point is to decide when we should

describe the quantum dynamics with a unitary Schrödinger equation, and when we should describe it with the projection postulate of wavefunction collapse. This problem was, of course, well known to the founders of quantum mechanics and is also sometimes called the “Heisenberg cut” – where should we cut off when to describe physical systems as having classical properties versus describing them as being in a coherent quantum superposition?

This question brings us into the 1980s, where a school of thought arose that we could solve this measurement problem with the process of *decoherence*. The basic idea runs as follows: We know that in reality quantum systems are not isolated, and interact with their environment. This environment can also be described quantum mechanically. However, it is impractical – perhaps even impossible – to control every aspect of it, so it is natural to average over the dynamics of the uncontrolled and unobserved environment. Rather than use a pure quantum state, the concept of the mixed quantum state of the subsystem is then of great utility, which is a statistical mixture of pure states. Mixed states include pure quantum states, but also include classical statistical mixtures – for example, how we describe the results of a classical coin flip where the randomness is simply a reflection of our ignorance of the “microstate” of the coin. Technically mixed states are described with density matrices, which generalize the concept of state vectors. Mixed states are reviewed in Appendix B.

The idea of decoherence is that the environmental interaction degrades the quantum coherence of a pure state, converting it into more palatable classical statistical mixtures. In describing the dynamics of a system of interest with an environment, the effect of the simplest type of coupling is to add a phase to the off-diagonal density matrix elements (defined in a basis specified by the environmental coupling). This phase depends on the state of the environment, so that the dynamics of the subsystem should be averaged over the fast environmental dynamics. The result of this is that the off-diagonal density matrix elements are suppressed, resulting in a purely classical statistical mixture. The basic insight advocated by physicists such as Wojciech Zurek (1981, 1982; see Fig. 1.2) was that the environment dictates the manner of decoherence the system experiences, and quantum measurement should be seen as a kind of decoherence. At the very least, this explains why coherence is difficult to maintain in large quantum systems, or systems not isolated from their environments. This approach, fully within the standard canon of quantum mechanics, was very popular at the time.

The shortcoming of the decoherence worldview is that no measurement – in our sense of learning something about the system – ever takes place until the very end when all coherence is removed. The theory describes statistical ensembles, not measured data. The fact that decoherence theory does *not* explain individual measurement results shows it is not a fundamental theory of measurement, and



Figure 1.2 Hiking photos of Karl Kraus (left) and Wojciech Zurek (right), reclining. Reproduced with permission from wikimedia.org under CC-BY SA, and from W. Zurek.

more is required despite common impressions from the recent literature. We will see in later chapters that when the environment is monitored, a (stochastic) pure state description of the dynamics can be restored, bringing us back to a collapse process.

At the same time, Kraus (1981, 1985) and Kraus et al. (1983), continuing in the line of Sudarshan et al. (1961) and Davies (1976), were also working on the theory of open quantum systems and developed the concept of a quantum process, or quantum dynamical system. This is closely related to a dynamical description of the open quantum systems of Lindblad (1976), as well as Gorini et al. (1976). We will return to these concepts in the coming chapters. While correctly capturing the dynamics of open quantum systems, including the decoherence process, these approaches do not fully capture the informational aspects of quantum theory, which brings us into the Quantum Information age. Let us first take a tour through some of the classic experiments that helped to form our understanding of the field.

1.4 Classic Experiments: 1970–1980s

The last quarter of the twentieth century was a tremendously active period in which the seeds for another quantum revolution were sown, particularly as new experimental tools and techniques became available. These developments coincided with new theoretical ideas put forward by Bell and others, and their confluence led to experimental tests of uniquely quantum mechanical effects. While many notable experiments should be highlighted in a thorough review of quantum milestones, we will discuss only a few exemplars that have had a profound impact in the field,



Figure 1.3 From left to right: Alan Aspect excitedly lecturing, Serge Haroche giving instruction, Leonard Mandel looking relaxed. Reproduced with permission from wikimedia.org and wikipedia.org under CC BY-SA, and Marlan Scully.

affirming the basic postulates of quantum theory and laying the foundation for modern quantum technologies in communication, computation, and sensing. In particular, we detail advances in photonics, atomic physics, and superconducting circuits, along with the basic configurations of these classic experiments.

Photons and Atoms

The invention of the LASER (Light Amplification by Stimulated Emission of Radiation) played a tremendous role in expanding the bounds of quantum measurement. Invented in 1960 by Theodore H. Maiman, this optical device was an advance on the MASER built in 1953, the microwave frequency version, invented by the group of Charles Townes. Townes, together with Basov and Prokhorov, won the 1964 Nobel Prize in Physics “for fundamental work in the field of quantum electronics, which has led to the construction of oscillators and amplifiers based on the maser-laser principle.” With this source of coherent photons with narrowly defined optical frequency, one could precisely excite desired atomic transitions with great specificity as well as produce sparse sources of emission where the granularity of individual light quanta were readily observed and the statistics of their generation and detection were imprinted with the signatures of quantum theory.

The experiments to test Bell’s inequalities, see Fig. 1.4, performed by Alan Aspect and co-workers (Aspect et al., 1981, 1982) were truly paradigm shifting. Aspect sought to realize the theoretical experiment proposed by Bell with as few modifications as possible – a single source producing entangled, polarized photons, captured by two distant detectors whose mutual output correlations could be quantified to prove the persistence of quantum interactions, even at a spacelike physical separation.

The contribution of Aspect’s team. – Aspect’s work incorporated several technical advances, which allowed the violation of Bell’s inequalities to be verified with

many standard deviations of precision. While, as mentioned earlier, several beautiful experiments aimed at observing EPR correlations preceded Aspect's work, they were subject to the challenges of technical noise and drift. Furthermore, in the detectors, the measurement outcomes for two different polarization states were not on an equal footing. A particular polarization direction was transmitted and no signal was expected for the orthogonal one, making it difficult to distinguish between a missing photon's "click" in the presence of poor measurement efficiency and the true absence of an absorbed photon. These new experiments used a radiative cascade decay in calcium-40 pumped by a krypton laser to produce a bright entangled photon source that produced 50 pairs per microsecond and enabled an experimental run to be completed in 100 s, avoiding slow drift in the apparatus. The dual channel polarizers employed were cubes comprised of two prisms coated with thin film dielectrics so that parallel polarization was transmitted and perpendicular polarization reflected; both outcomes could be detected using two photomultiplier tubes, essentially creating a Stern–Gerlach analogue for photons.

In its early version, the polarizers were stepped through relative orientations to calculate the correlations between detection events; Bell predicted that entanglement between the photon pairs would lead to stronger correlations than can be obtained with any classical system with a varying degree of departure from classical statistics depending on the angle between the detectors. Indeed, the predictions of Bell were unambiguously observed. However, one could argue that since the directions of the polarizers were fixed before the generation and emission of the photon pairs, classical information exchange could be responsible for such observations. Aspect, Dalibard, and Roger (Aspect et al., 1982) partially addressed this loophole by not selecting the orientation of the polarizers in the detection system until after the entangled photons were generated, and distancing each detector 6 meters from the source. Each dual channel polarizer was now replaced by a pair with two different fixed orientations, and an incoming photon was directed into one or the other depending on the state of an acousto-optic switch that flipped every 10 ns; see Fig. 1.4(a). This time, as well as the internal 5 ns delay in the atomic cascade, was much shorter than the 40 ns photon transit time, thereby spacelike separating the detectors and supporting the notion of the nonlocality of quantum entanglement. While not completely free of all loopholes, this work elevated quantum entanglement from a theoretical notion to very tangible property that could be measured in any experiment conceived to date.

The contributions of Mandel's team. – In the Aspect experiment, a single photon is incident on a dual-channel polarizer and will traverse one path or the other. Another distinct facet of quantum measurement science is observed when two identical photons are incident on the two input ports of a 1:1 beam splitter, as shown in Fig. 1.5(a). Each impinging photon can be either transmitted or reflected, giving

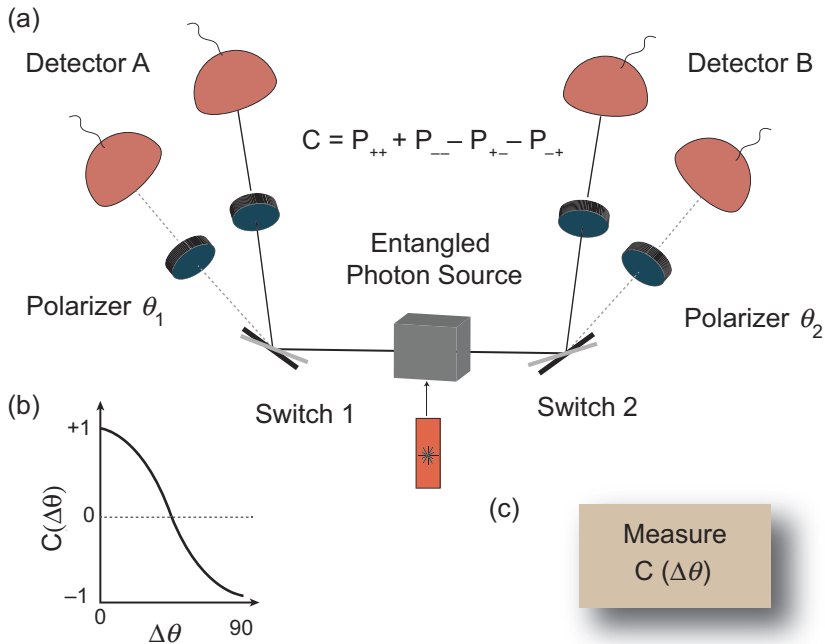

Figure 1.4 (a) A Bell's inequality setup involves shuttling the two constituent photons, produced from an entangled photon source, through two spacelike separated detection arms, each with a variable polarizer and a photomultiplier tube for detection. To address possible local communication loopholes, a fast switch is used to randomly select between two possible polarizer orientations after an entangled photon pair is produced. (b) The correlation coefficient, C , is plotted as a function of the relative polarizer angle, $\Delta\theta$, between the two arms. (c) The quantity to measure is the correlation function of photon coincident counts.

rise to four possible outcomes for two-photon incidence. Surprisingly, rather than being equally distributed among these four cases, the two photons preferentially bunch. An ideal beam splitter would not have any memory of which outcome actually occurred, requiring us to add the probability amplitudes of all four possibilities, shown in Fig. 1.5(b) on an equal footing to predict the output state. Note that the two cases corresponding to both photons being reflected or transmitted, labeled 3 and 4 in the figure, respectively, are physically indistinguishable for fully identical particles. Additionally, an ideal beam splitter is unitary, and thus reflections on one side of the beam splitter acquire a π phase shift. As such, the probability amplitudes for both particles being reflected or transmitted destructively interfere and cancel each other. This means that identical photons that spatially overlap when they enter the two input ports of a beam splitter will always exit together through the same output port, as depicted in cases 1 and 2. This effect was observed by Hong, Ou, and Mandel (HOM) (Hong et al., 1987) at the University of Rochester

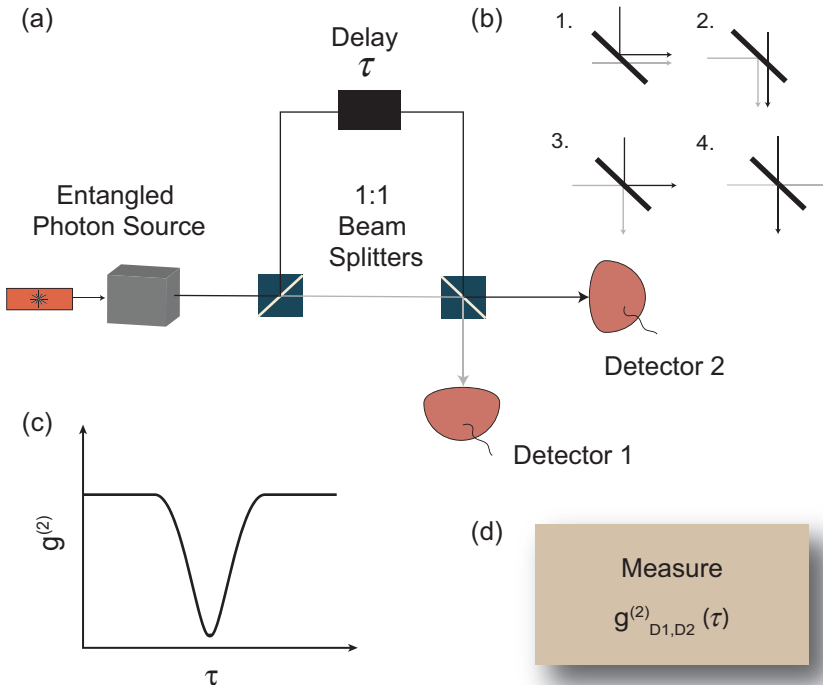

Figure 1.5 (a) The Hong, Ou, and Mandel (HOM) effect is seen as the bunching of output photons when an identical pair is incident on an ideal 1:1 beam splitter. (b) Of the four possible photon trajectories (1–4), shown in the upper right, the wave amplitudes corresponding to both photons being reflected (3) and transmitted (4) have equal magnitude and opposite sign, and thus interfere destructively, resulting in both photons always exiting the output beam splitter through the same port (1,2). (c,d) A time delay τ is inserted in one arm to measure the second-order correlation function $g^{(2)}$ as a function of temporal coincidence. The dip is when the timing of the photons arriving at the beam splitter is perfect.

in 1987, and is manifest as a dip in the coincident count rate observed in two detectors monitoring the two output ports of the beam splitter; see Fig. 1.5(c,d). The HOM dip, named after the trio that discovered it, is complete (i.e. the correlation function goes to 0) for perfectly identical photons and degrades in proportion to the degree of photon distinguishability. Notably, for the case of classical light described by a coherent state, a dip is also observed but only drops to 0.5 at best. Thus, the HOM effect is indeed quantum mechanical and has a distinct measurement signature. It is used extensively to verify the purity of single photon sources, and also underlies the basic operating principle for producing an effective, measurement-mediated gate interaction in linear optical quantum computing, such as in the Knill–LaFlamme–Milburn (KLM) protocol (Knill et al., 2001).

The contributions of Haroche's team. – Around the same time period, another fundamental quantum state was being pursued: the Schrödinger cat state. The classic thought experiment of Erwin Schrödinger (1935) has a feline cohabiting a box with an unstable radioactive atom in a superposition state of having decayed and not decayed. This indeterminacy is transferred to the cat which is then simultaneously dead and alive. Serge Haroche and coworkers, including J. M. Raimond and M. Brune at ENS Paris, developed a series of experiments (Brune et al., 1990, 1996) where single photons could be trapped in an extremely high-finesse cavity through which individual atoms could be transited, as shown in Fig. 1.6. In such a cavity quantum electrodynamics setup, described by the model of Jaynes and Cummings (1963), the itinerant circularly polarized Rydberg atom (a highly excited atom, with its electron(s) having a large principle quantum number) traverses a microwave cavity and is a sensitive probe of the intracavity photonic field. Haroche and the team established a Schrödinger cat state of order 10 photons in the cavity and reconstructed its dynamics by probing it with a series of atoms sent through the cavity one at a time. Physicists now had a powerful laboratory for dissecting decoherence in a small, well-controlled bath. The physics of light–matter interactions beautifully showcased in these experiments directly influenced the field of circuit-based cavity quantum electrodynamics that would follow two decades later, and introduced many techniques currently employed in modern neutral atom quantum computing. For these and related accomplishments, Serge Haroche together with David J. Wineland won the 2012 Nobel prize.

Superconducting Circuits

During the 1980s, another set of outstanding fundamental questions in quantum theory were being pursued in parallel. Quantum mechanics has its roots in the physics of light and atoms, and in particular the phenomena of photon emission from solids and gases. Does the theory apply to electrical circuits? Pioneering research to answer this question was undertaken by Anthony Leggett, John Clarke, and their collaborators. Leggett, recipient of the 2003 Nobel Prize in Physics for his work on the theory of superfluidity, has written extensively on the topic of macroscopic quantum coherence (Leggett and Garg, 1985), and quantitative measures of how macroscopic a system actually is, which continue to be a topic of contemporary research. On the experimental front, a team of researchers at University of California, Berkeley in the laboratory of J. Clarke realized a set of experiments that put electronic circuits on the same footing as their microscopic cousins, establishing a powerful testbed for testing fundamental concepts in quantum theory in an open quantum system (well coupled to a complex bath), and a versatile toolset for future Quantum Information processing hardware.

The Berkeley experiments employed a Josephson tunneling junction to realize a quantized nonlinear oscillator. Superconductivity, in a very basic hydrodynamic

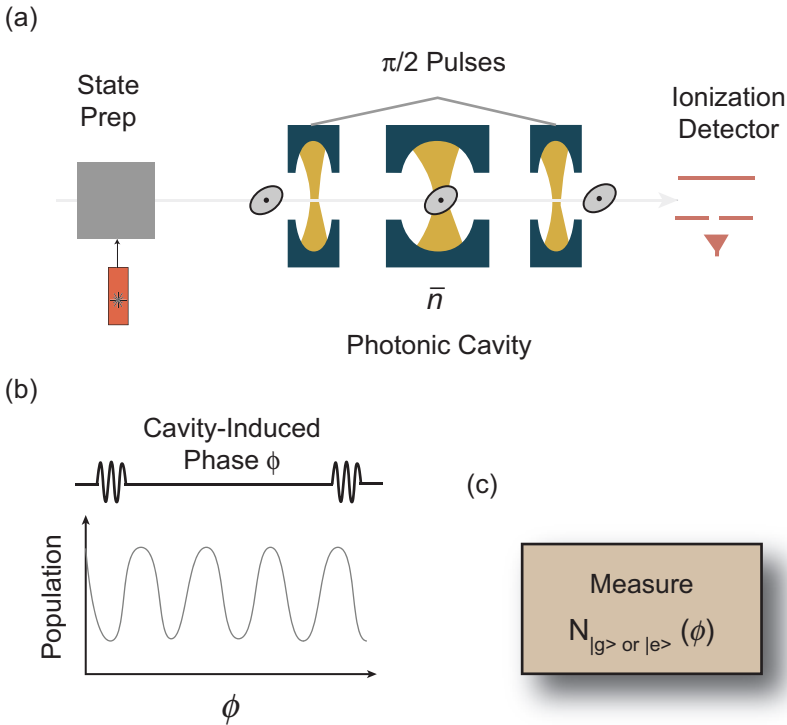

Figure 1.6 (a) In an atomic cavity quantum electrodynamics experiment, itinerant single atoms traverse a central microwave cavity populated on average with \bar{n} photons, and a strong light–matter interaction results in entanglement. This imprints a phase shift ϕ on the effective two-level atomic wavefunction which can be probed by Ramsey spectroscopy. (b) Applying a pair of $\pi/2$ pulses at the input and output of the central cavity followed by state-selective field ionization detection to measure (c) the number of atoms (N) in a particular state results in an oscillation of the average population of either the ground or excited state with ϕ . Diminishing contrast signals the presence of decoherence. Schrödinger cat states can be readily formed by adjusting the interaction time of the photonic field with a single atom such that, when the latter is produced in an equal superposition of two Rydberg states, it becomes maximally entangled with the former after exiting the cavity.

description, results from an effective pairing interaction between single dressed electrons that transforms a normal metal into a condensate that can be described by a quantum mechanical amplitude and phase. When two superconductors are separated by a barrier, be it a normal metal or an insulator, then a phase difference can be established between the two superconducting electrodes that determines the transport properties of the junction. Brian Josephson, recipient of the 1973 Nobel Prize in Physics for the effect that bears his name, showed that the current flowing across such a junction is proportional to the sine of the gauge-invariant phase difference across the device, and the voltage is proportional to its time derivative.

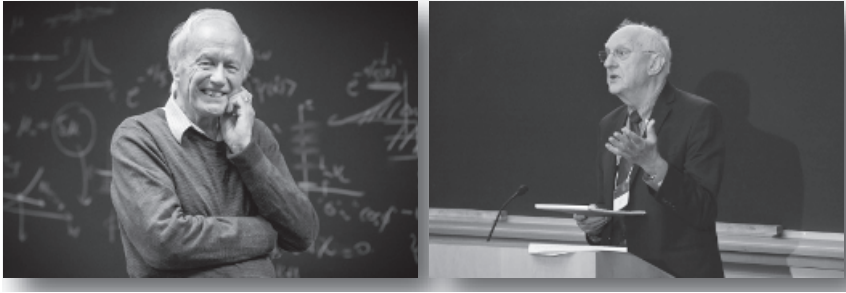

Figure 1.7 A smiling Anthony Leggett (left) and an earnest John Clarke (right) in front of the blackboard. Photo Credits: University of Illinois/L. Brian Stauffer and University of California/S. Wittmer.

These equations describe the motion of a fictitious particle in a cosine potential whose coordinate is given by the phase difference across the junction (Josephson, 1974).

In an experiment carried out by Devoret et al. (1985), the transition from the superconducting state, characterized by zero DC resistance, to the voltage-state was used as a measurement probe of when the fictitious particle describing the junction dynamics was static and confined to a single well of the cosine potential or if it had escaped, resulting in a time evolution of the phase difference at a finite rate, as illustrated in Fig. 1.8(a,b). By applying a static current to the junction, the potential well was tilted, effectively lowering its barrier and eventually allowing the particle to escape under the influence of thermal and quantum fluctuations. At sufficiently low temperature, the transition rate to the voltage state, Fig. 1.8(c), became independent of the physical temperature of the junction, indicating that the dominant source of fluctuations was quantum zero-point motion which drove a quantum mechanical tunneling process rather than a classical Arrhenius type of activation over the top of the potential barrier. This result was a dramatic demonstration that a collective macroscopic variable can behave in full accordance with the postulates of quantum mechanics.

An important practical difference between photonic/atomic and superconducting circuits, however, is that the latter are inherently open quantum systems that readily couple to both the vacuum and the imperfections of a solid-state environment. In a second experiment, the Berkeley team excited the Josephson junction oscillator with a microwave field to drive the system to an excited state which would then rapidly tunnel to the resistive state of the junction and produce a readily detected voltage signal (Martinis et al., 1985). A critical technological advance in this experiment was the use of highly attenuating filters, specifically made of metallic copper powder, that would attenuate microwave signals over a very wide

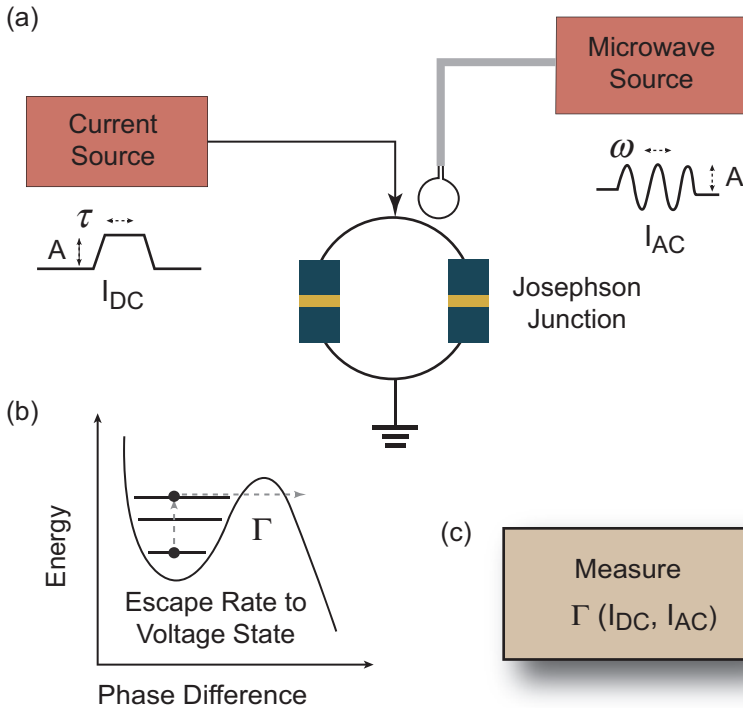

Figure 1.8 (a) A superconducting quantum interference device is shown that contains two Josephson junctions. The Josephson junction is a superconducting nonlinear electrical oscillator whose dynamics can be described by (b) the motion of a fictitious particle through a periodic potential. A static current tilts the potential wells and microwave pulses drive resonant transitions. By using a combination of both of these excitations, the energy level structure of the oscillator can be ascertained by (c) measuring the escape rate Γ of the junction out of the potential well via macroscopic quantum tunneling as the signature that the external microwave drive has excited the system out of a lower energy level.

range of frequencies and effectively shunt the junction with a high impedance. Without such control of the dissipative environment surrounding the junction, the linewidth of the individual quantized levels within a well of the periodic junction potential would be too broad to allow for their spectroscopic isolation. These experiments directly mapped the specific energy levels of the junction, establishing that a Josephson junction is essentially a nonlinear quantum oscillator with distinct particle-in-a-box type energy levels. Several subsequent experiments with D. Esteve and C. Urbina further elucidated the critical role played by the impedance shunting the junctions on its dynamics (Esteve et al., 1986; Urbina et al., 1991). A single junction was later used as a phase quantum bit, or “qubit” (Martinis et al., 2002) – the elementary unit of quantum computation, and circuits with different

shunting elements and junction count gave rise to the current flora of charge- and flux-controlled superconducting qubits (Clarke and Wilhelm, 2008).

1.5 The Quantum Information Era: 1990s–Present

With the notion of quantum entanglement on a much firmer experimental footing, ideas related to possible advances in computation and metrology based on quantum coherence began to take shape. The concept of projective measurement and its use in secure communication was appreciated earlier, with the celebrated work of Bennett and Brassard appearing in 1984 (Bennett and Brassard, 1984; Bennett and Brassard, 2014). The BB84 protocol used the fact that measurements of the polarization state of a polarized photon will collapse into a definite outcome, faithfully representing the preparation of the photon, when the detector orientation is aligned with the initial polarization of the photon, or will result in a probabilistic outcome when the measurement and polarization axes are not commensurate. Thus, the choice of initial polarization and measurement detection constitute a key to securely encode and decode sensitive information, with the added bonus that the action of an eavesdropper could be readily discerned by the observation of incorrect measurement statistics.

Additional developments in quantum sensing took place during this period that took advantage of non-classical manifestations of light such as squeezed states (Walls, 1983) where fluctuations are asymmetrically distributed between two quadratures, such as photon number and phase, allowing one to surpass the so-called standard quantum limit of measurement sensitivity. Analogous quantum behavior was later demonstrated in matter, for example in the spin degree of freedom of trapped atoms and ions (Wineland et al., 1992). Extensions to many-body quantum states such as NOON states (Kok et al., 2002) have also been proposed, and represent a route to obtaining quantum enhanced scaling (Heisenberg limit) in measurement sensitivity, which in quantum metrology represents an improved scaling in which the measurement sensitivity increases with the resource of a measurement such as the time of the experiment or the number of photons used, and is a topic of contemporary research.

The concept of a quantum computer that was more powerful than classical computers on an algorithmic level was a huge advance. Quantum algorithms have been developed that can perform certain tasks faster than the best known classical algorithms. The most promising algorithms (such as Shor's factoring algorithm (Shor, 1994)) give an exponential speedup, while others (such as Grover's search algorithm (Grover, 1996)) give a polynomial speedup. We will give a more in-depth discussion of this area later in the chapter. While also utilizing quantum coherence for enhancements over classical technology, computing has additional

requirements, most prominently the need to both control and measure entanglement over an extant array of quantum objects, with numbers ranging anywhere from a few hundred to a million. Quantum state measurement in such an architecture is challenging, as one cannot simply decouple from the surrounding environment to maintain coherence, as such attenuation would reduce the signal-to-noise-ratio, and clever schemes are needed to effectively filter out noise channels that cannot be probed by the experimentalist. Much work has been carried out on a variety of platforms, including nuclear magnetic resonance systems for ensemble-based computation, and by ion trap–based architectures. Constructing high-efficiency amplifiers and detectors with near-quantum-limited sensitivity has been critical for progress in solid-state and photonic quantum computing platforms. Superconducting nanowire and Josephson junction devices have provided access to single-shot projective measurements, and sufficiently high-quality weak measurements to execute both proof-of-concept quantum algorithms and new classes of fundamental tests of quantum theory.

In addition to a readout resource, measurement can also be integrated directly into the computational step of a quantum processor. In particular, the effective nonlinearity associated with the measurement process can be used to generate entanglement between two qubits traveling through linear guided wave elements, and can also execute one-way or measurement-based quantum computing (Raussendorf et al., 2003) with specific, highly entangled cluster states such that a destructive measurement deterministically yields the results of a desired computation. Such methods are actively being pursued in photonic architectures where the weak interaction between photons and losses in nonlinear elements makes conventional quantum mediated by direct photon–photon interaction a challenge.

Technology, Foundations, and Philosophy

In the preceding section, we discussed the advent of quantum information science as a branch of information theory and computing, discussing the concept of quantum advantage, or “supremacy.” It is nowadays possible to find the view of quantum computing as a respectable, trendy, cutting-edge, hard science, while research in quantum foundations is practiced by philosophers of physics, at best, or charlatans, at worst. However, it is our strong belief that the field of quantum computing and the field of quantum foundations are really two sides of the same coin.

Indeed, while Richard Feynman is credited with the basic idea of quantum simulation, pointing out that a quantum system is best suited for simulating other quantum systems (Feynman, 1982), the modern field of quantum computing may be said to begin with a conversation between Charles Bennett and David Deutsch, of whom the latter proposed the general formulation of a quantum computer (Deutsch, 1985), and in a further development of that paper, together with Richard

Jozsa, developed the first quantum algorithm that showed a computational advantage compared to its classical counterpart (Deutsch and Jozsa, 1992). This was two years prior to Peter Shor's celebrated factoring algorithm paper (Shor, 1994), and four years prior to Grover's search algorithm (Grover, 1996).

It is fitting that Deutsch helped to start this field. An eccentric genius, he has never held a conventional faculty job (or indeed, any job), but continues to the present day to hold courtesy appointments and stay home writing books. He is also passionate about topics of fundamental importance. In Deutsch's first paper on the topic, he repeatedly discusses the Everett many-worlds' interpretation in the presentation of his ideas as the only possible interpretation. We bring it up here to stress that quantum computing began as an exercise in quantum foundations research, by a scientist who has never had a job. Progress in quantum mechanics, as in science in general, can only be made by pushing the limits of a theory, both practical and conceptual. By asking questions that have never been asked, proposing new kinds of experiments, and searching for new phenomena in the lab, we can hope to come to a deeper understanding of the physical world. Sometimes that can bring up bizarre ideas, and work in quantum foundations continues to the present day.

In the context of quantum measurement, while its origins must be clearly understood to underpin the foundations of the theory, it can also be used as a resource for quantum information tasks. Measurement can be – and often is – used to prepare quantum states before a quantum information task begins. It can be used to monitor and correct errors in the context of a quantum error correction protocol. It can even be used to generate entangled states between distant quantum systems. The trick is to do it right – measurement is no longer simply “looking”; what you choose to learn changes the system being measured, and by learning selectively and carefully, it becomes another tool in the box of the quantum mechanic.

1.6 Generalized Measurements

Quantum mechanics is a theory of probability. As such, it is important to understand the mathematics of probability and different ways to understand probability as a concept. In classical probability theory, we learn simple principles; that, after defining a set of possible events, by observing the frequencies of the events, one can define an empirical probability distribution in the limit of many events.

Reasoning about Ignorance: Classical Probability Theory

The mathematics of probability is the systematic reasoning about degrees of ignorance, such as the probabilities of disjoint events are to be added, while the probabilities of two independent events are to be multiplied. We can also define the notion of joint and conditional probabilities when reasoning about multiple events.

The conditional and the unconditional probabilities are related by the law of total probability, which we will discuss in Chapter 3. The conditional probabilities can be related to each other by Bayes' rule, which provides a powerful way to reassign probability assignments based on the availability of new data – this concept will also be explored in more detail in Chapter 3. We review the mathematical formulation of probability theory in Appendix A. There are two main schools of thought about probability theory – the first is the “frequentist” school. This approach to probability is that probability is only a meaningful concept in the first situation outlined above – as the limit of large data concerning the frequencies of outcomes. The second is commonly called the “Bayesian” school of thought, which can best be summarized as “probability is not real,” and is merely a reflection of our beliefs about a given situation. The reader can then well appreciate that, if there is such a diversity of thought about the meaning of classical probability theory, quantum mechanical schools of thought about the interpretation of the theory are even more varied! We will give a reflection on them in the epilogue at the end of this book.

Quantum Mechanics as a Generalized Theory of Probability

The above examples of classical information theory have quantum generalizations. One of the fundamental principles of quantum mechanics, the uncertainty principle, gives a limit to our ability to reduce the joint uncertainty of complementary variables. This illustrates that notions inherent in classical probability theory must be suitably generalized when applying statistical reasoning to quantum mechanical systems. Quantum systems do not have only probabilities of outcomes; rather we assign wavefunctions or state vectors to the system (or more generally, density matrices) as a generalized notion of probability. These state vectors encode a richer space of possible measurement outcomes. There is more information contained about the system than simply the probabilities of the outcomes in a fixed basis; the quantum states also contain the coherences between the states that are important to keep – in particular when explaining a sequence of measurement results or measurements in a variety of different bases.

When we confront common examples of measurements applied to quantum systems in the lab, we quickly realize that the idealized wavefunction collapse assumption breaks down, and a new concept is necessary. The simplest way of generalizing this concept of wavefunction collapse is to draw on the previously mentioned model of von Neumann, and to introduce another system into the analysis that plays the role of the measuring device. This device need not be described classically, and indeed should be treated fully quantum mechanically. If we allow both entities to interact with each other over some period of time, then the resulting joint state will become entangled. We cannot correctly describe the measurement

outcome statistics of one without referencing the other. Viewing one of the systems as the “meter” allows us to apply the projection postulate to that subsystem, giving us the probability of the readout apparatus when the system is also not directly measured. In this way, we have indirect access to the system of interest. By examining the meter outcomes, we can use our understanding of the correlations between the system and the meter encoded in the entangled state to make inferences about the quantum state of the system – even if it is previously unknown to us. The way we can assign probabilities to the meter results, as well as how the quantum state is disturbed by the measurement process, can be formalized, and this will be discussed extensively in Chapters 3 and 4. This is usually described in the literature with a poor choice of name – “positive operator-valued measures,” or POVMs. We will usually just refer to this formalism as generalized measurement. Once the formalism is in place, the role of the meter can be abstracted away, and we discuss the system again in isolation under the influence of these new kinds of generalized measurement; however, we should not forget about the other part of the story and that there are other degrees of freedom that are ultimately responsible for these disturbances.

Breaking the Cardinal Properties of Textbook Measurements

Generalized measurements lead to many interesting phenomena that break the cardinal properties of textbook measurements: its projective nature, its irreversible nature, and its instantaneous nature.

On breaking projection. – One of the first consequences of the previously mentioned generalization is the concept of the information versus disturbance trade-off. By varying how long the system and the meter interact with each other, the amount of entanglement can be varied from zero to a maximum. The act of then measuring the meter gives rise to two corresponding effects – the first is the amount of information we can learn about the system of interest from the meter, and the second is the degree of disturbance we give to the system’s quantum state. On one side of the limit is textbook wavefunction collapse – we obtain perfect knowledge of the property of the quantum system we are measuring when there is maximal entanglement between system and meter, with an associated projection of the quantum state onto the eigenstate of the observed property. On the other side of the limit is when there is no entanglement between the system and meter, and consequently no knowledge of the properties of the system is obtained. The system state is completely unaffected by what happens to the meter. We can move continuously between these extremes by varying the degree of entanglement between system and meter. The greater the knowledge we obtain about the system, the larger the associated disturbance is.

A very interesting limiting case here is the concept of a “weak measurement.” In this case, we consider a limiting process where there is only a tiny amount of entanglement between system and meter. The resulting measurement of the meter is mostly uncorrelated with the state of the system – but a tiny amount of correlation remains. By repeating the process many times with identically prepared systems, and averaging the results of the meter over that ensemble, it turns out that the average system property can be extracted, even though the disturbance to the system state is arbitrarily small in each run of the experiment. This limit is useful to formalize, since we can discuss certain counterintuitive properties of quantum systems in the limit of negligible disturbance – essentially taking a peek into the workings of the quantum world without much of the associated baggage of projective measurements.

On breaking irreversibility. – We have already discussed how the projection property must be generalized into a partial wavefunction collapse. Another property that falls is the irreversible nature of measurement. Let us recall the words of Niels Bohr: “It is imperative to realize that in every account of physical experience one must describe both experimental conditions and observations by the same means of communication as one used in classical physics. In the analysis of single atomic particles, this is made possible by irreversible amplification effects – such as a spot on a photographic plate left by the impact of an electron, or an electric discharge created in a counter device – and the observations concern only where and when the particle is registered on the plate or its energy on arrival at the counter” (Bohr, 2010). Bohr lays the source of classicality in the measurement result at the feet of irreversible amplification. In his famous article “Law Without Law,” John Wheeler expresses this idea with poetic flare: “We are dealing with an event that makes itself known by an irreversible act of amplification, by an indelible record, an act of registration” (Wheeler and Zurek, 2014). He credits the use of the word “indelible” to the Dutch physicist Belinfante (2016).

One great discovery in the study of generalized quantum measurement is that just because the act of amplification is irreversible and associated with an indelible measurement record does not mean that wavefunction collapse is. We have seen that wavefunction collapse can be seen as lying upon a continuum, depending on the strength of the entanglement between system and meter. For this reason, we can consider a sequence of two generalized measurements – one that partially collapses the state, and another that “uncollapses” the state to restore it. The necessary condition for the second uncollapsing measurement is that the net information acquired about the system in both measurements – each of them indelible – is zero. That is, while both measurements are the result of amplification, the right combination of measurement results leaves the quantum state of the system untouched – as if it had never been measured in the first place. Remarkably, this is true even if the observer

has no idea what the original quantum state is. We will go into greater detail about this startling effect in Chapter 8.

On breaking instantaneity. – Once we have the concept of a sequence of two generalized measurements, it is a natural step to the concept of a continuous measurement. This is the last, and most dramatic, paradigm break from textbook measurement theory, where we learn that the measurement process is instantaneous. While this idea of instantaneous collapse is latent in the writings of Einstein, it is made explicit by Heisenberg: “There is then a definite probability for finding the photon either in one part or in the other part of the divided wave packet. After a sufficient time the two parts will be separated by any distance desired; now if an experiment yields the result that the photon is, say, in the reflected part of the packet, then the probability of finding the photon in the other part of the packet immediately becomes zero. The experiment at the position of the reflected packet thus exerts a kind of action (reduction of the wave packet) at the distant point occupied by the transmitted packet, and one sees that this action is propagated with a velocity greater than that of light. . .” (Heisenberg, 1949). Heisenberg’s idea that the wavepacket reduction is immediate (or instantaneous) has become part and parcel of textbook quantum mechanics.

However, it has gradually become clear to physicists that all measurements take some time to occur. This naturally leads to the question “How long?” concerning the associated wavefunction collapse. The answer to this question simply depends on you, the experimenter. It can take as long or short a time as you like, in principle. More formally, we can distinguish two main types of time-continuous measurements, “quantum jumps” and “quantum diffusion.” They are both characterized by acquiring information about the quantum system at some rate, leading to the dynamics of the quantum system no longer described only by the Schrödinger equation, but by another type of dynamics we will examine in the following chapters. We can consider this type of continuous measurement as being mathematically described as a repeated sequence of weak measurements where the measurement strength limits to zero as the time window of the description is decreased. Like all stochastic processes, quantum diffusion is only a quasi-continuous process in reality, holding when there is a wide separation of timescales between the system dynamics and the dynamics of the detector. What is remarkable about the resulting formalism is that the underlying quantum state of the system can be “tracked” in time as the data stream comes in from the detector. These so-called “quantum trajectories” can be followed and validated even for a single run of the experiment, despite the fact that they cannot be predicted in advance. The mathematical description of this set of phenomena goes beyond both projection operators and the Schrödinger equation. We must describe the combination of continuous, coherent, and nonunitary dynamics of the quantum state. These topics will be explored in detail in Chapters 5 and 6.

1.7 What You Will Learn in This Book

This text assumes some familiarity with quantum mechanics and builds on it. You will learn about the topics we introduced in this chapter, along with other related topics. While the text is laid out in a pedagogical way from cover to cover, the reader who wants to learn immediately about a certain topic can consult the chart that follows for a list of key topics and chapters in the text, as well as a flowchart for following a sub-thread of the topics, shown in Fig. 1.9. The flowchart is organized in three main topics – Fundamental Concepts, Advanced Topics, and Applications and Implementations. Depending on your interest, you can skip to the chapter of interest and follow the other order of study.

Fundamental Principles

In Chapter 2, we will review basic facts of quantum measurement that are usually discussed in basic texts on quantum mechanics. These include a motivating experiment – the Stern–Gerlach effect – and discussions of measurement results, statistics, the Born rule, and wavefunction collapse. Chapter 3 takes a step beyond textbook measurements and introduces generalized measurements, beginning with the motivating experiment of an optical polarization measurement with a calcite crystal. In this case, wavefunction collapse is imperfect, and we discuss how to describe and predict the statistics of outcomes and how to assign postmeasurement states. This topic is closely related to Bayesian probability theory, and we discuss a “Quantum Bayes Rule.” In Chapter 4, we take a limit where the coupling of the measurement apparatus to the quantum system is very small, and in this limit, we discuss weak measurements and weak values. The latter involves a sequence of a weak and a strong measurement. We discuss generalizations of these effects using the concepts in Chapter 3, and introduce generalized eigenvalues of quantum observables that can exceed the eigenvalue range, expanding the concept of observables in generalized measurement theory.

Advanced Topics

This section moves away from discrete sequences of measurements and dives into quantum measurement as a dynamical process. Chapter 5 considers the case of *diffusive* continuous measurements, where the measurement outcomes and quantum state dynamics is analogous to a Brownian noise process. We motivate this type of measurement by considering the example of a double quantum dot quantum system being measured by a quantum point contact. The intrinsic shot noise of the measurement naturally brings about an effective time-continuous measurement. A second example of a superconducting circuit made from a Josephson junctions readout with a microwave-frequency electromagnetic wave is also discussed in detail. The mathematics of a formally continuous quantum trajectory theory is then pedagogically built up, resulting in the stochastic Schrödinger equation,

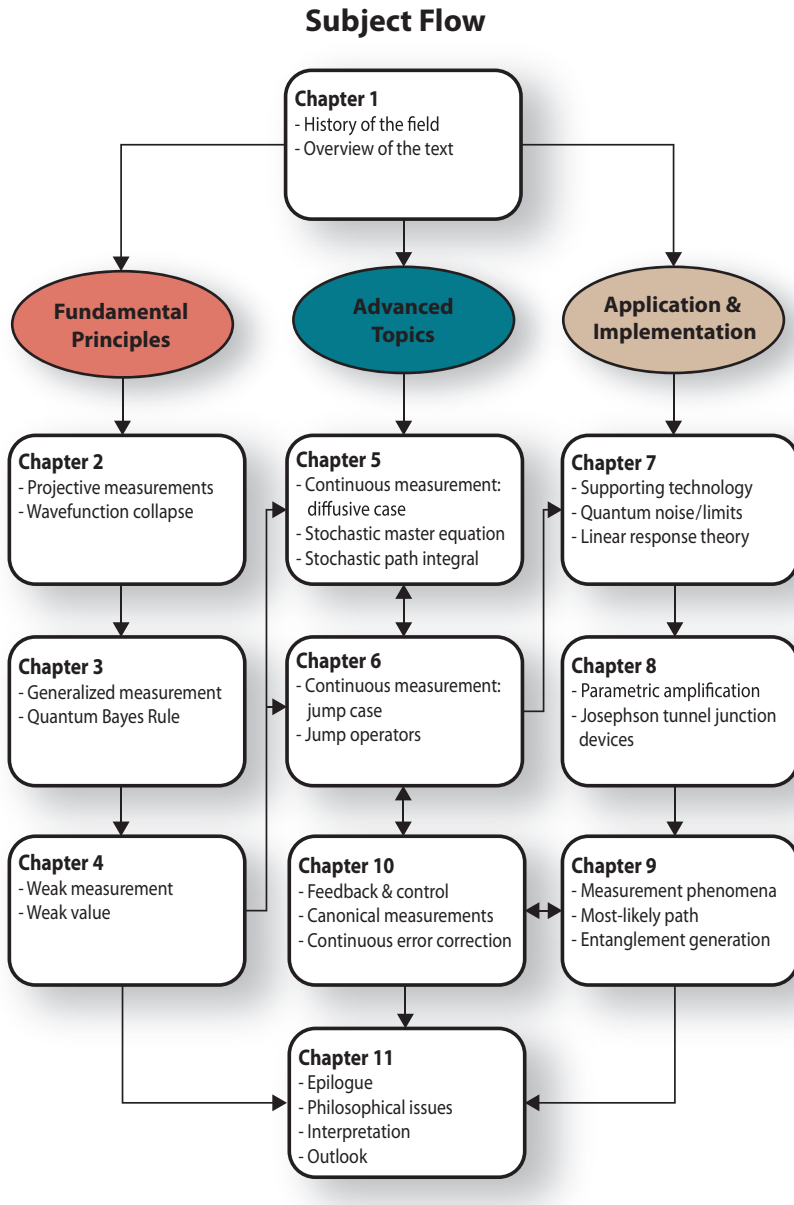

Figure 1.9 Possible reading flow of this book. The chapters are listed vertically by themes. Arrows indicate possible reading order of the chapters, depending on reader expertise and interest.

the stochastic master equation, and the stochastic path integral. We also discuss experimental data and its comparison with this theoretical formalism. These

experiments allow us to peer into the inner workings of wavefunction collapse, giving an empirical handle on the many philosophical issues that arise in quantum measurement.

In Chapter 6, we discuss quantum jumps, or leaps, beginning with a historical discussion and giving the motivating example of blinking atoms in trapped ions and quantum jumps in superconducting circuits. Despite the disruptive name, we discuss how jumps fit into the category of continuous measurement. In some cases, quantum jumps can be predicted and even reversed. We build up the mathematical formalism by discussing the quantum Zeno effect, Lindblad-type master equations, leading to jump and no-jump dynamics – an inseparable combination of discrete and continuous dynamics. In fact, the discrete nature of the jump is illusory. We discuss the dynamics of a quantum jump and the transition from jumps to diffusion.

We now jump to Chapter 10 and discuss feedback and control as an advanced topic. We introduce how to use the measurement results to control the quantum system by applying quantum operations that are conditional on the measurement outcome. A number of experimental systems are discussed, including active qubit phase stabilization, adaptive phase measurements, and continuous quantum error correction.

Application and Implementation

This category covers many important topics that support the measurement process, and interesting phenomena that arise. In Chapter 7, we discuss the fundamental limits of quantum amplification. When quantum degrees of freedom are amplified to classical signals, noise from the amplifier is added to the signal (there are exceptions, but other trade-offs come into play). A detailed discussion of linear response theory is given, which is applicable to many kinds of quantum-limited measurements, where the best compromise between information extraction and quantum disturbance is made. This theory is applied to mesoscopic charge detectors and resonant optical cavities. While the fundamental bounds quantum mechanics gives to amplification are important, they do not tell you how to invent a quantum-limited amplifier.

In Chapter 8, we devote a whole chapter to how quantum amplifiers work. We discuss phase-preserving and phase-sensitive amplification and how to realize these with heterodyne and homodyne measurements. Focusing on quantum superconducting circuits, we discuss three-wave and four-wave mixing, and the different types of circuits to build in order to realize amplification, and how it can go wrong.

Chapter 9 explores many interesting phenomena that arise in the physics of continuous quantum measurement. We discuss measurement reversal (or “quantum uncollapse”), the most likely path of continuous quantum measurements, the joint simultaneous measurements of noncommuting observables, and entanglement of distant quantum systems by continuous measurement.

The book concludes with Chapter 11, where we give in an epilogue a more philosophical reflection on the state of the field. We discuss what it all means, where the field is going, how quantum computers are the ultimate test of quantum mechanics, and speculate on a future post quantum science.